

Discourse Representation Theory

Hans Kamp, Josef van Genabith, Uwe Reyle

CONTENTS

1	INTRODUCTION	4
2	A DYNAMIC AND REPRESENTATIONAL ACCOUNT OF MEANING	6
2.1	Truth Conditions, Discourse and Interpretation in Context	6
2.2	Donkey Sentences	8
2.3	DRT - the Basic Ingredients	9
3	BASIC DRS LANGUAGES AND THEIR INTERPRETATIONS	23
3.1	A First-Order, Extensional DRS Language	23
3.2	Intensional Semantics, Propositions, Information States and Con- text Change Potential	31
3.3	Generalised Quantifiers	41
3.4	Plural	57
3.5	Tense and Aspect	71
3.6	A First-Order DRT Calculus	121
4	PRESUPPOSITION	131
4.1	Introduction	131
4.2	Examples	133
4.3	Syntax and Semantics of Preliminary Representations	160
4.4	Accommodation and Inference.	175
4.5	Construction of Preliminary Representations	183
4.6	Conclusion	192
5	PROPOSITIONAL ATTITUDES	194
5.1	Introduction	194
5.2	Extending DRT to a Formalism Capable of Describing Attitudinal States and Attitude Attributions. Some Examples Semi- Formally Treated	195
5.3	Syntax and Semantics of the Extended Formalism	209
5.4	Construction of Representations of Attitude Attributing Sentences and Texts	224
6	LEXICON	254
7	UNDERSPECIFICATION	254

1 INTRODUCTION

Discourse Representation Theory, or DRT, is one of a number of theories of dynamic semantics, which have come upon the scene in the course of the past twenty years. The central concern of these theories is to account for the context dependence of meaning. It is a ubiquitous feature of natural languages that utterances are interpretable only when the interpreter takes account of the contexts in which they are made - utterance meaning depends on context. Moreover, the interaction between context and utterance is reciprocal. Each utterance contributes (via the interpretation which it is given) to the context in which it is made. It modifies the context into a new context, in which this contribution is reflected; and it is this new context which then informs the interpretation of whatever utterance comes next.

The focus on context dependence has led to an important shift in paradigm, away from the “classical” conception of formal semantics which sees semantic theory as primarily concerned with reference and truth and towards a perspective in which the central concept is not that of truth but of information. In this perspective the meaning of a sentence is not its truth conditions but its “information change potential” – its capacity for modifying given contexts or information states into new ones. Theories of dynamic semantics, which have been designed specifically to deal with the two-way interaction between utterance and context, all reflect this change of paradigm. Nevertheless, the connection between information and truth is of paramount importance and they are a crucial ingredient of all dynamic theories. DRT differs from certain other dynamic theories [Groenendijk and Stokhof1991],[Groenendijk and Stokhof1990],[Chierchia1991, Kohlhase *et al.*1996, Eijck and Kamp1997] in that the role it attributes to truth is especially prominent - so much so, in fact, that some comparisons between the different types of dynamic theories have gone so far as to qualify DRT as “static”. There is some justification for this allegation, but nevertheless DRT contains within it the essence of all that distinguishes dynamic semantics from earlier “static” semantic theories, such as in particular, Montague Grammar, which were exclusively concerned with reference, truth and satisfaction.

Context dependence in natural language is an extraordinarily complex and many-faceted phenomenon. Anaphoric pronouns - pronouns which refer back to something that has been introduced previously in the discourse - represent perhaps the most familiar kind of context dependence; and certainly it is the kind that has been most thoroughly investigated, within linguistics, philosophy and Artificial Intelligence. But it is only one of many, and to get a proper perspective on context dependence and its theoretical implications it is important to consider others too. Thus a substantial part of this survey will look at cases of context dependence other than anaphoric pronouns, and at the implications they have for the structure of DRT and of dynamic semantics generally.

We will start, however, with a review of the DR-theoretical treatment of pronominal anaphora, retracing the steps which led to its original form. This will motivate the basic formal version of “classical” DRT, in which the central charac-

context

information change potential

dynamic semantics

teristics of the DR-theoretical approach are easiest to recognize.

This is a handbook of philosophical logic. Thus it seems natural to emphasize the general logical architecture of DRT and its philosophical applications. These will be discussed in **Sections. ??**. Or decision to give priority to these aspects of the theory has forced us to be silent or very brief on others. Thus our choice of DRT-based treatments of natural language phenomena has been guided by the consideration that those we present here should reveal important logical or philosophical issues. Many of the treatments that can be found in the existing DRT literature have been left out.

We also remain almost entirely silent on the quite extensive work on computer implementations of DRT. As the following sections should make clear, the representational character of DRT renders it especially suitable for implementations - as some computer scientists have put it, the theory can be looked upon as a high level program specification. While we see this amenability to implementation as an important feature of DRT, and as one that also has a clear logical and conceptual importance, the specific problems to which implementation gives rise fall outside the horizons that we consider appropriate for this Handbook. However we will discuss, in Section 3.1, versions of DRT which have been partly inspired by the goal to cast the theory in forms which make its computational properties more transparent and thus facilitate implementation in a large variety of computational environments [Asher1993, Bos *et al.*1994, Muskens1996].

Closely connected with the question of implementation is an issue that becomes unavoidable when semantic analyses are made fully explicit. All natural language semantics is concerned with the question how meaning is determined by syntactic form. Thus every explicit semantic analysis must assume some form of syntactic structure for the natural language expressions with which it is concerned. The choice of syntax is something from which many presentations of DRT have tried to remain aloof - out of the conviction that the specifically DR-theoretical contributions that DRT can make to our understanding of semantic problems are largely independent of the details of syntactic theory and thus should be explained in as syntax-neutral a mode as possible. Nevertheless, the general endeavour of linguistic theory - to arrive at an optimal description of all linguistic properties of natural languages - includes the task of finding the optimal account of its syntax no less than finding an optimal account of its semantics. From this perspective the viability of DRT will depend also on its compatibility with what may come to be recognized, perhaps on largely independent grounds, as the best - or the right - theory of syntax.

At present there are versions of DRT building on many of the leading syntactic frameworks - in particular LFG [Kaplan and Bresnan1982], HPSG [Pollard and Sag1994], and forms of Categorical Grammar [Steedman2001] and of GB [Chomsky1981]. As the interface problems posed by these different combinations seem to us to have limited repercussions for the logical and philosophical aspects of DRT, this is a part of the DRT literature which we have also decided to pass over. Here as elsewhere we refer the reader to the bibliography.

2 A DYNAMIC AND REPRESENTATIONAL ACCOUNT OF MEANING

Traditionally, formal approaches to natural language semantics have focused on individual sentences and tried to explicate meaning in terms of truth conditions. Nevertheless it had long been acknowledged that content and context are closely related and in fact strongly determine each other. This is nowhere more evident than in the case of multi-sentence natural language texts and discourses which can constitute highly structured objects with a considerable amount of inter- and intrasentential cohesion. Much of this cohesion can be traced back to anaphoric properties of natural language expressions, that is their capacity to refer back to (or point forward to) other expressions in the text.¹ Pronominals and tense are but two examples of anaphoric devices – devices whose anaphoric nature was realised many years ago but which, it turned out, were difficult to capture with the machinery available within formal semantics in the 60's and 70's.

When formal semantic approaches were extended to capture inter- and intrasentential anaphoric phenomena, it soon became evident that (i) the narrow conception of meaning in terms of truth conditions has to give way to a more dynamic notion and (ii) the traditional analysis of (NP) anaphora in terms of bound variables and quantificational structures has to be modified. Below we briefly retrace some of the basic and by now often rehearsed² arguments.

DRT is probably still best known for its treatment of the inter- and intrasentential anaphoric relations between (originally singular) indefinite NPs and personal pronouns *s/he*, *it*, *him*, *her*, *his* and *its*. In this section we will concentrate on this part of the theory and somewhat arbitrarily refer to this part as “core DRT”.³

2.1 *Truth Conditions, Discourse and Interpretation in Context*

In predicate logic ([Hodges2001]) the following two expressions are truth conditionally equivalent

$$(1) \quad \exists x\Phi \Leftrightarrow \neg\forall x\neg\Phi$$

If Φ is instantiated to $(\textit{delegate}(x) \wedge \textit{arrive}(x))$, then the two formulas are approximate semantic representations of

$$(2) \quad \text{A delegate arrived.}$$

¹DRT and other dynamic semantic theories focus on textual anaphora. This is not meant to indicate that deictic and common ground etc. anaphora are in any sense considered less important.

²C.f. the introductory sections of [Kamp1981a], [Heim1982], [Groenendijk and Stokhof1991], [Groenendijk and Stokhof1990] and textbooks such as [Gamut1991] and [Kamp and Reyle1993].

³Historically this is somewhat inaccurate since the original motivation for the development of DRT was provided by accounts of temporal anaphora. Here it should also be mentioned that DRT did not come completely “out of the blue”. Some of the central concepts were in some form or other already present and/or being developed independently at about the same time as the original formulation of DRT in e.g. the work of [Karttunen1976], [Heim1982] and [Seuren1986].

and

(3) It is not the case that every delegate failed to arrive.

While (2) can be extended into the mini-discourse

(4) A delegate^{*i*} arrived. She_{*i*} registered.

where anaphoric relationships are indicated by subscripts for anaphors and corresponding superscripts for their antecedent head-words, its truth-conditionally equivalent counterpart (3) does not admit of any such extension:⁴

(5) * It is not the case that every delegate^{*i*} failed to arrive. She_{*i*} registered.

Truth conditions alone fail to capture the contextual dimension of sentence interpretation. Intuitively (and pre-theoretically) the difference between (2) and (3) (and hence the difference between (4) and (5)) can be accounted for as follows: (2) *updates* the initially available context with an antecedent which can be picked up by anaphoric expressions in subsequent discourse; the truth conditionally equivalent (3) doesn't.

It might be presumed that at least simple intersentential anaphora of the type illustrated by the well-formed discourse in (4) could be captured with the machinery provided by traditional Montagovian approaches [Montague1973]. On this approach sentence sequencing (i.e. the full stop) is analysed as conjunction and the semantic contribution of the antecedent NP (*a delegate*) “put on ice” and later “quantified-in” into a representation for the conjunction of the first and the second sentence in (4) in which the same variable instantiates the subject positions of the two conjoined clauses:

context
context update

(6) $(\lambda P.\exists x(delegate(x) \wedge P(x)))(\lambda y.arrive(y) \wedge register(y))$

(6) can be reduced to

(7) $\exists x(delegate(x) \wedge arrive(x) \wedge register(x))$

On this account, however, a discourse consisting of *n* sentences may have to be processed in its entirety with NP meanings on hold before finally quantifying-in can take place. Such an approach fails to capture the *on-line* character of discourse processing by a human interpreter. Worse still, this approach delivers wrong results. Consider (8) and (9):

(8) Exactly one delegate arrived. She registered.

(9) Exactly one delegate arrived and registered.

⁴Here and in what follows the asterisk * in (5) indicates linguistic unacceptability.

It is not possible to analyse (8) by treating the full stop between the two sentences as conjunction and then quantifying-in the phrase *exactly one delegate* with logical form $\lambda P \exists x (delegate(x) \wedge P(x) \wedge \forall y [(delegate(y) \wedge P(y)) \rightarrow x = y])$. For this associates (8) with the truth conditions of (9), as given in (10), whereas the truth conditions of (8) are rather those of (11). In words, (8) rules out than any other delegates arrived while (9) is compatible with this possibility as long as those further delegates did not register.

$$(10) \quad \exists x (delegate(x) \wedge arrive(x) \wedge register(x) \wedge \forall y [(delegate(y) \wedge arrive(y) \wedge register(y)) \rightarrow x = y])$$

$$(11) \quad \exists x (delegate(x) \wedge arrive(x) \wedge \forall y [(delegate(y) \wedge arrive(y)) \rightarrow x = y] \wedge register(x))$$

2.2 Donkey Sentences

donkey sentences

Traditionally, indefinite NP's have been translated into logic as predications involving existential quantification with intrasentential anaphors referring back to the indefinites as variables bound by the existential quantifiers. In many cases, this approach delivers the right results. However, puzzles associated with "donkey sentences" (originating in the middle ages and discussed in [Geach1962 Third revised edition 1980]) show that indefinites cannot be translated uniformly into existential quantifications and demonstrate the need to revise the traditional quantificational bound variable approach to such NP anaphora.

$$(12) \quad \text{If Pedro}^i \text{ owns a donkey}^j, \text{ he}_i \text{ likes it}_j.$$

$$(13) \quad \text{Every farmer who owns a donkey}^j \text{ likes it}_j.$$

It is widely agreed that (on at least one prominent reading) the truth conditions associated with (12) and (13) correspond to (14) and (15), respectively:

$$(14) \quad \forall x [(donkey(x) \wedge own(pedro, x)) \rightarrow like(pedro, x)]$$

$$(15) \quad \forall x \forall y [(farmer(x) \wedge donkey(y) \wedge own(x, y)) \rightarrow like(x, y)]$$

In (14) the indefinite NP *a donkey* in (12) surfaces as a universally quantified expression taking wide scope over the material implication operator. By contrast, in a sentence like (2) the indefinite *a delegate* has existential import. The occurrence of the indefinite noun phrase *a donkey* in (13) poses similar problems. The indefinite NP, this time located inside a relative clause modifying a universally quantified NP, surfaces as a universally quantified expression with wide scope in (15).

quantifying-in

Interpreting (12) under the quantifying-in approach illustrated in (6) - (11) results in

$$(16) \quad \exists x (donkey(x) \wedge [own(pedro, x) \rightarrow like(pedro, x)])$$

while a direct insertion approach (where quantified NPs are interpreted in situ [Montague1973]) produces an open formula, in which the x in the consequent of the material implication is not bound:

$$(17) \exists x[\text{donkey}(x) \wedge \text{own}(\text{pedro}, x)] \rightarrow \text{like}(\text{pedro}, x)$$

Neither (16) nor (17) are adequate representations of the perceived meaning (14) of (12). (16) comes out true in case there is (at least) one donkey Pedro doesn't own and (17) doesn't even express a proposition.

2.3 DRT - the Basic Ingredients

Examples (2), (3), (4) and (5) illustrate the need to extend the narrow conception of meaning as truth conditions to a more dynamic notion of meaning relative to context. Examples (8) and (9), (12) and (13) illustrate the need to reconsider the traditional quantificational and bound variable approach to nominal anaphora on the intra- and intersentential level.

In the original formulation of DRT [Kamp1981a, Kamp and Reyle1993] interpretation involves a two stage process: first, the construction of semantic representations, referred to as Discourse Representation Structures (DRSs), from the input discourse and, second, a model-theoretic interpretation of those DRSs. The dynamic part of meaning resides in how the representations of new pieces of discourse are integrated into the representation of the already processed discourse and what effect this has on the integration of the representations of subsequent, further pieces of discourse. Put differently, a new piece of discourse is interpreted against and in turn updates the representation of the already processed discourse and the meaning of a linguistic expression consists both in its update potential and its truth-conditional import in the resulting representation. The dynamic view of meaning in terms of updates of representations and the attempt at a *rational reconstruction* of the on-line and incremental character of discourse processing by human agents naturally leads to an algorithmic specification of DRS-construction in [Kamp1981a, Kamp and Reyle1993]. To process a sequence of sentences S_1, S_2, \dots, S_n the construction algorithm starts with a syntactic analysis of the first sentence S_1 and transforms it in a roughly top-down, left-to-right fashion with the help of DRS construction rules into a DRS K_1 which serves as the context for the processing of the second sentence S_2 . The syntactic analysis of S_2 is then added *to* and incrementally decomposed *within* the context DRS K_1 . Semantic contributions of constituent parts of S_2 are integrated into DRS K_1 as soon as they become available, eventually resulting in a complete DRS $K_{1,2}$ for the sequence S_1, S_2 . Truth conditional interpretations are provided for completed DRSs $K_1, K_{1,2}, \dots, K_{1,\dots,n}$ but not for intermediate steps involving application of DRS construction rules. In its original formulation, DRT tries to do justice to a conception prevalent in a number of AI, Cognitive Science and Linguistics approaches (cf. [Fodor1975]) according to which

the human mind can be conceived of as an information processing device and that linguistic meanings are best viewed as instructions to dynamically construct and update a mental representation, which can then be employed in further mental processing (such as theoretical and practical reasoning). At the same time, complete meaning representations are associated with truth-conditional semantic interpretations. DRT's decidedly representational stance has inspired (or provoked) research on a large number of "non-representational" approaches to dynamic semantics, cf. [Zeevat1989, Groenendijk and Stokhof1991, Groenendijk and Stokhof1990, Muskens1996, Eijck and Kamp1997, Harel1984].

dynamic semantics

In the early nineties a new DRT architecture was proposed by Van Der Sandt and Geurts [van der Sandt1992, Geurts and van der Sandt, Geurts1999, Kamp2001a, Kamp2001b], based on a general treatment of presupposition [Soames1984]. Informally speaking, a (linguistic) presupposition is a requirement that a sentence imposes on the context in which it is used. If the context doesn't satisfy the presuppositions imposed by the sentence, it may be modified through "accommodation", i.e. modified or updated to a new context which does satisfy them. If the context neither satisfies all the presuppositions of the sentence nor can be accommodated to one that does, then interpretation aborts; these are cases in which interpreters perceive the sentence as incoherent in the context in which it occurs. Within such an account of presupposition anaphoric expressions such as pronouns can be treated as carrying presuppositions of a special kind, viz. that a suitable antecedent is available for them.

presupposition

Within the new DRT architecture presuppositions are treated via a two stage procedure. First, a "preliminary" representation is constructed for each individual sentence in which all presuppositions which the sentence carries are given explicit representations. During the second stage the presuppositions represented in the preliminary representation are checked against the context; when necessary and feasible, the context is accommodated. When all presuppositions have been satisfied, the remaining non-presuppositional part of the preliminary representation is merged with the (original or updated) context; the result is a DRS which includes both the context information (possibly with its accommodations) and the contribution made by the sentence.

A further difference between the original version of DRT and the new version is that in the former representations are constructed top-down – the syntactic structure of a sentence is decomposed starting from the top node which represents the sentence as a whole – whereas in the new version construction proceeds bottom-up: the preliminary representations are constructed from syntactic trees by first assigning semantic representations to the leaves of the tree and then building representations for complex constituents by combining the representations of their immediate syntactic parts. In this section we will give a brief impression of both the old and the new architecture. (Details of the old version of DRT can be found in [Kamp and Reyle1993]. For alternative bottom-up constructions see e.g. [Asher1993, Muskens1996, Eijck and Kamp1997]. In the present article a bottom-up construction algorithm will be described in some detail in Section ??.)

We begin with a description of some of the basic tools (such as DRSs, DRS conditions, accessibility, etc.) which are characteristic for the general DRT enterprise.

The DRT-based solutions to interpretation in context and context update (with inter- and intrasentential anaphora) are based on (i) a novel conception of logical form and (ii) the use of Discourse Referents (DRs) to represent the semantic contributions made by noun phrases (as well as certain other sentence elements). The logical forms of DRT are the DRSs already mentioned. DRSs can be extended and merged, and in this way DRSs representing sentences can be combined into DRSs that represent multi-sentence discourses. DRs are DRS constituents which serve to represent entities and which could be described as “variables” that are subject to a novel form of binding. This new form of binding allows among other things for a new treatment of indefinite NPs (which are among the contributors of DRs to sentence and discourse representations), a treatment which accounts for their potential as anaphoric antecedents to pronouns (recall, e.g., the difference between (4) and (5)).

Discourse Representation Structures

Semantic representations in DRT are specified in terms of a language of DRSs. Simple DRSs are pairs consisting of a set of discourse referents U - often referred to as the “universe” of the DRS - and a set of conditions Con . The general form of a DRS is as in (18).

(18) $\langle U, Con \rangle$

Intuitively, the universe collects the discourse entities talked about in a discourse while the conditions express constraints (properties, relations) on those discourse entities. Simplifying somewhat,⁵ sentence (2) (*a delegate arrived*) corresponds to the DRS

(19) $\langle \{x\}, \{delegate(x), arrive(x)\} \rangle$

or, in the often used pictorial “box notation”,

(20)

x
delegate(x)
arrive(x)

In what follows we will make use of *both* the box notation and the linear notation. The box notation provides better readability especially in the case of complex DRSs (it displays the anaphoric possibilities provided by a context at a glance) while the linear, set based notation saves space and is the basis for formal definitions of syntax, semantics and proof systems for the DRS language.

⁵Abstracting away from tense, aspectual phenomena etc.

Informally, the indefinite *a delegate* in (2) contributes the discourse referent x to the universe of the DRS in (20) and the atomic condition $\text{delegate}(x)$ to its set of conditions. The VP *arrived* contributes the atomic condition $\text{arrive}(x)$. The associated semantics (cf. Definition 0.10) ensures that this simple DRS is true in a model just in case there *exists* a mapping from the discourse referents of the DRS into the universe of the model such that all the conditions in the set of conditions come out true. In this way discourse referents in the top box of a DRS are endowed with existential force and sets of conditions are interpreted conjunctively.

DRS Conditions and Accessibility

Discourse referents have a double function. On the one hand they serve as antecedents for anaphoric expressions such as pronouns, on the other they act as the bound variables of quantification theory. This second function entails that discourse referents must be able to stand to each other in certain scope relations. To mark these relations we need the concept of a “sub-DRS”: DRSs can occur as constituents of larger DRSs. As it turns out, this mechanism provides a natural explanation of the chameleonic quantificational import (existential or universal) of indefinite NPs like those in (2), (12) or (13). Sub-DRSs always occur as part of *complex* DRS conditions. By contrast, the DRS conditions we have seen so far are *simple* or *atomic* DRS conditions. Two examples of complex DRS conditions are those involving implication and negation.

Conditional sentence constructions of the form *if* S_1 *then* S_2 such as (12) involve a complex DRS condition of the form:

$$(21) \quad \boxed{K_{S_1}} \Rightarrow \boxed{K_{S_2}}$$

which consists of DRSs for the sentences S_1 and S_2 , respectively, joined by the \Rightarrow operator. Similarly, negation introduces a complex condition of the form

$$(22) \quad \neg \boxed{K_S}$$

which contains the DRS K_S for the sentence S in the scope of the negation as its subconstituent. To give an example, sentence (12) gives rise to the following DRS:

$$(23) \quad \boxed{\begin{array}{c} x \\ \text{predro}(x) \\ \boxed{\begin{array}{c} y \\ \text{donkey}(y) \\ \text{own}(x,y) \end{array}} \Rightarrow \boxed{\begin{array}{c} z \ w \\ \text{beat}(z,w) \\ z = x \\ w = y \end{array}} \end{array}}$$

Sub-DRS

DRS condition ! complex

DRS condition ! atomic

DRS condition ! conditional

DRS condition ! negative

The truth conditions (cf. Definition 0.10) associated with DRS (23) involve a wide scope universal quantification over the discourse referent y associated with the indefinite *a donkey*. Intuitively the interpretation of the conditional says that in order for (23) to be true it must be the case that *whenever* a situation obtains that satisfies the description provided by the antecedent of the conditional, then a situation as described by the consequent obtains as well. In other words, the consequent is *interpreted and evaluated* in the context established by the antecedent. The natural language paraphrase of the truth conditions associated with (23) expresses the universal force with which the indefinite *a donkey* in (12) is endowed. Furthermore, since the consequent is interpreted in the context set by the antecedent, the truth-conditional requirement that situations in which the antecedent is true be accompanied by situations in which the consequent is true is tantamount to situations of the former kind being part of (possibly more comprehensive) situations in which antecedent and consequent are true together. This is the informal justification of why discourse referents introduced in the antecedent of the conditional are available for resolution of anaphors in the consequent but not vice versa. It also explains why the universal quantifier expressed by the conditional is *conservative* in the sense of generalized quantifier theory [Westerstl1989]. The conservativity of other natural language quantifiers follows in the same way, cf. Section (3.3) below. DRS construction for a universal NP with a relative clause containing an indefinite NP, as in (13), proceeds in a similar manner.

The semantics of conditional DRS conditions, then, is based on the principle that the interpretation of the antecedent can be extended to an interpretation of the consequent. This principle entails that a pronoun in the consequent can be interpreted as anaphoric to a constituent in the antecedent, i.e. the pronoun's discourse referent can be linked to the one introduced by this constituent. Such anaphoric links are subject to what is called *accessibility* in DRT, a relation which must hold between the linked discourse referents and which obtains if, informally speaking, the pronoun occurs within the logical scope of its antecedent. On the other hand, discourse referents from the consequent of a conditional are in general not accessible to pronouns in the antecedent. So there is an asymmetry in the accessibility relation here: discourse referents introduced by constituents in the antecedent are accessible to the consequent but not vice versa (unless they are allowed to "escape" to a higher position in the DRS, cf. the discussion on proper names below). The accessibility relation turns out to play a central role in the DR-theoretical account of when anaphora is possible and when not. How DRS-constructors - which, like those of (21) and (22), create complex DRS conditions - affect accessibility, is an essential aspect of the semantic analysis of the natural language constituents (*if ... (then) ... , not* etc.) which they are used to represent. It can be argued, along lines similar to the argument we have given for conditionals above, that the discourse referents within the scope of a negation operator \neg are not accessible from outside the SubDRS which is in the scope of the negation operator and similarly for discourse referents in the scope of a conditional operator \Rightarrow (again, unless they can "escape"). As long as \Rightarrow and \neg are the only complex DRS condition constructors,

DRS condition ! quantificational

donkey sentence

truth

accessibility

the accessibility relation can be graphically described in terms of the geometrical configurations of the box representation of the DRS language as going *left and up*.

The structure of the DRS determines, via its model-theoretic interpretation, the quantificational import of discourse referents it contains. In this way indefinites are interpreted as terms which receive different quantificational import depending on where the discourse referents they introduce end up within the DRS. To a considerable extent, therefore, the variable binding role of quantifiers in traditional predicate logic or within the higher type Intensional Logic used in Montague Grammar style representations is taken over in DRT by the DRS universes, which in effect act as quantifier prefixes, and by the structure of DRSs which defines the scope and binding properties of these DRS universes.

We are now in a position to account for the contextually relevant difference between the truth-conditionally equivalent (2) and (3) that is manifest in (4) and (5). (2) and (3) are mapped into the DRSs in (24) and (25), respectively:

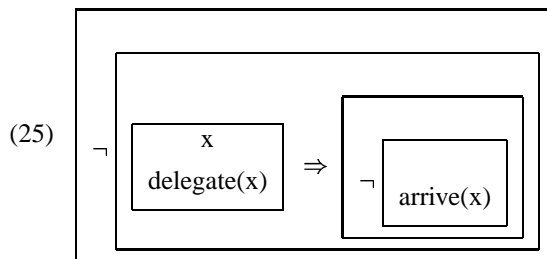
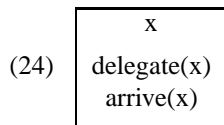

(24) and (25) are truth-conditionally equivalent, as can be verified against the semantics given in Definition 0.10. However, (24) can be extended to an anaphorically resolved DRS

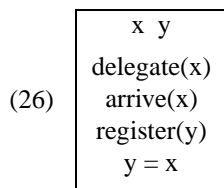

representing the two sentence discourse (4), while (25) can only be extended to the unresolvable

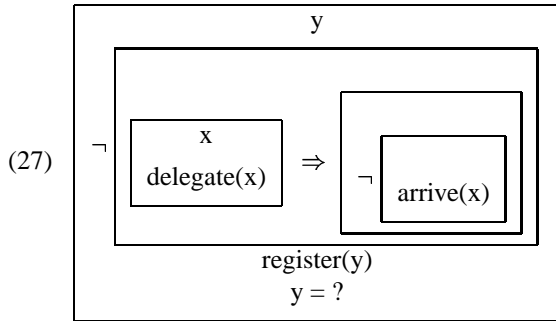

where the remaining resolution instruction $y = ?$ indicates that no antecedent for the pronoun *she* has been found.

Finally, let us consider the pair of sentences in (8) and (9). An analysis of sentence sequencing as conjunction together with a quantifying-in approach as the last step in the derivation would ascribe a complex property $\lambda x.(arrive(x) \wedge register(x))$ to the representation $\lambda P.\exists x(delegate(x) \wedge P(x) \wedge \forall y[(delegate(y) \wedge P(y)) \rightarrow x = y])$ of the quantifying NP *exactly one delegate* in one fell swoop resulting in the formula $\exists x(delegate(x) \wedge arrive(x) \wedge register(x) \wedge \forall y[(delegate(y) \wedge arrive(y) \wedge register(y)) \rightarrow x = y])$. In contrast, in the DRT approach a discourse referent x is set up by the indefinite NP *a delegate* in the first sentence and then incrementally constrained by the addition of further conditions:

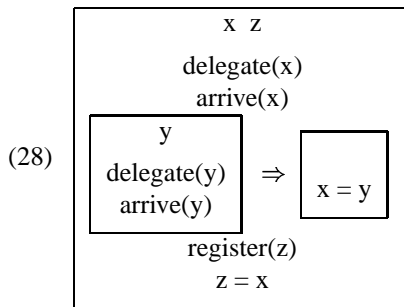

In this way we obtain the truth conditions associated with the predicate logic formula $\exists x(delegate(x) \wedge arrive(x) \wedge \forall y[(delegate(y) \wedge arrive(y)) \rightarrow x = y] \wedge register(x))$ which are those intuitively associated with (8).

DRS Construction

DRS construction has been defined for many of the leading syntactic theories including (simple or decorated) CFG [Kamp1981a, Kamp and Reyle1993, Bos *et al.*1994], LFG [Reyle and Frey1983, Genabith and Crouch1999], HPSG [Frank and Reyle1995] and Categorical Grammar [Zeevat *et al.*1987] based approaches. Below we sketch the original top-down DRS construction algorithm and the more recent, bottom-up, presupposition-based version.

architecture ! top-down

A Top-Down Construction Algorithm: In the original formulation of DRT [Kamp1981a, Kamp and Reyle1993] the construction of DRSs is spelled out in terms of an algorithm based on DRS construction rules which successively decompose syntactic analyses for the individual sentences in a discourse into DRSs in a roughly top-down, left-to-right manner. Here we briefly and informally illustrate the algorithm with the two sentence mini-discourse (4), here repeated as (29):

(29) A delegate¹ arrived. She₁ registered.

As a first step the algorithm inserts the syntactic analysis of the first sentence in (29) as a “reducible condition” into an empty DRS representing an initial empty context. A DRS construction rule for indefinite NPs matches the relevant part of the tree, introduces a *new* discourse referent x into the universe of the DRS under construction and adds a condition $\text{delegate}(x)$ to the set of conditions. The matching part of the tree configuration is replaced by x . Next, a DRS construction rule for simple intransitive VP configurations applies. The matching tree is consumed and a condition $\text{arrive}(x)$ is added to the DRS condition. This completes the processing of the first sentence of (29).

DRS condition ! reducible

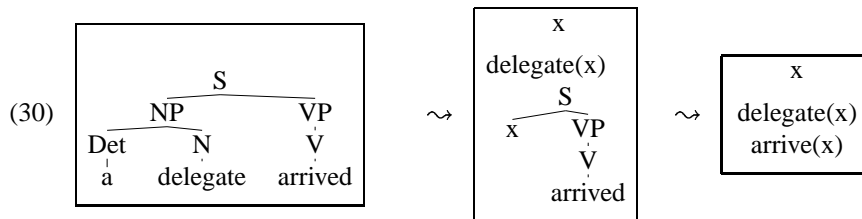

In the next step the top-down construction algorithm inserts the syntactic analysis of the second sentence in (29) as a reducible condition into the context DRS constructed from the first sentence. A DRS construction rule for pronominal NPs introduces a new discourse referent y into the universe of the DRS under construction, adds a condition $y = ?$ to the set of conditions and replaces the matching part of the tree with y . Informally, $y = ?$ can be understood as an instruction to find a suitable antecedent for the pronoun *she*. A suitable antecedent is a discourse referent already introduced and available in the context representation constructed so far. In the case at hand discourse referent x is available and the anaphor is resolved to $y = x$. Note that in this set-up the anaphoric NP *she* is resolved as soon as it is processed by the construction algorithm. The original DRS construction algorithm was in fact designed as a reconstruction of the on-line and incremental interpretation of a discourse by a human interpreter. In the final step the algorithm processes the intransitive VP in the same fashion as for the first sentence in (29):

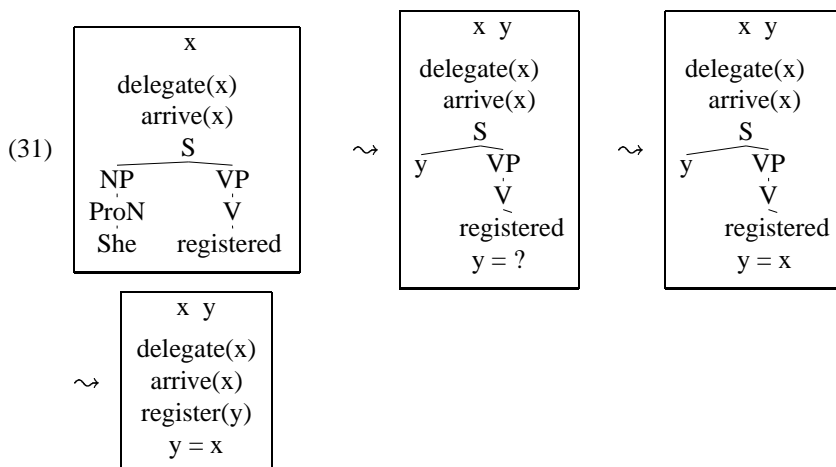

architecture ! bottom-up

Two Stage Bottom-Up DRS Construction: A top-down DRS construction algorithm of the kind sketched for a modest fragment of English is spelled out in detail in [Kamp and Reyle1993]. We already noted that the new, presupposition-based version of DRT makes use of a bottom-up construction process. In recent times bottom-up construction became increasingly common within DRT, and it will be assumed (if often only implicitly) throughout most of this survey. In the next few pages we present, briefly and informally, the essential steps involved in constructing a DRS for the mini-discourse in (29) in the more recent bottom-up and presupposition-based version of DRT.

As noted above, in the new version of DRT DRS construction proceeds in two stages: a preliminary sentence representation is constructed during the first stage and during the second stage the presuppositions of the sentence, which are explicitly represented in the preliminary DRS, are verified in their respective contexts, with or without context accommodation; when presupposition verification is successful, the non-presuppositional remainder of the preliminary representation is merged with the context representation (or with the representation of the accommodated context). The simplest preliminary representations for sentences with presuppositions are of the form $\langle P, D \rangle$, where D (a DRS) is the non-presuppositional part of the representation and P is a set of representations of the presuppositions of the sentence, where these representations also take the form of DRSs. In more complicated cases the set P may itself consist of preliminary DRSs (as a presupposition may rest in its turn on other presuppositions) and D too may have a more complicated structure which involves additional presuppositions.

We also noted that anaphoric pronouns are treated as carrying a presupposition that the context provides a suitable anaphoric antecedent. In fact, in the new version of DRT all definite NPs are treated as coming with a presupposition to the effect that there is a way of determining their reference which is independent of the remaining material on the sentential utterance to which the NP belongs; ref-

erence via coreference with an anaphoric antecedent is one of the various forms which this presupposition can take.

Indefinite NPs, on the other hand, are assumed to be without presupposition. It is this which sets them apart from definite NPs and allows them to make the quantifier-like contributions to sentence meaning which motivated the traditional treatment of indefinites as existential quantifiers. However, the novel form of binding which we mentioned earlier as one of the distinctive features of DRT, and which applies in particular to the discourse referents contributed by indefinites, distinguishes indefinites from “genuine” quantifier phrases like *every delegate* and makes it possible to account for the capacity of indefinites to act as antecedents for anaphoric pronouns in sentences like (12) and (13) and discourses like (4).

The absence of presuppositions connected with indefinites means that no presupposition is introduced by the subject NP *a delegate* of the first sentence of (29). So, if we assume that no other constituent of this sentence carries a presupposition, then the preliminary representation of the sentence will be that given on the right hand side in (32). The left hand side gives the representation of the context, which we have assumed to be empty.

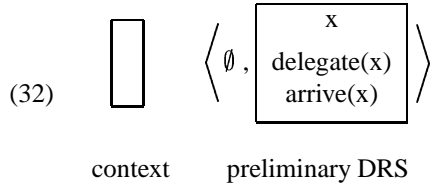

As there are no presuppositions to resolve, the non-presuppositional part of the preliminary DRS can be merged with the (initially) empty context. Here \uplus is the symmetric merge operation, i.e. $\langle U_1, \text{Con}_1 \rangle \uplus \langle U_2, \text{Con}_2 \rangle = \langle U_1 \cup U_2, \text{Con}_1 \cup \text{Con}_2 \rangle$.⁶

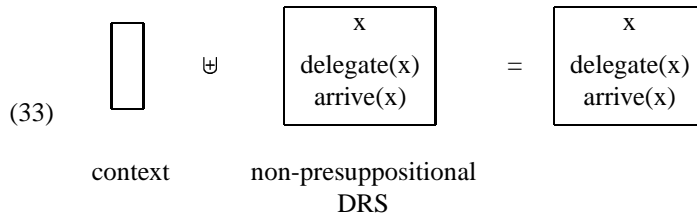

The result of the merge in (33) constitutes the new context DRS against which the preliminary DRS for the second sentence in (29) is interpreted:

⁶There exists an extensive literature on symmetric and non-symmetric merge operations including [Fernando1994, Vermeulen1995, Eijck and Kamp1997].

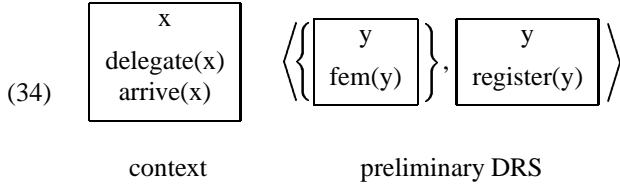

The presuppositional part of the preliminary DRS for the second sentence derives from the pronominal NP *She*. *She* requires a suitable antecedent, either one that has the property female or one that is neutral between a fe/male interpretation, to be available in the context established so far. In (34) a possible antecedent is provided in the form of the discourse referent x for *a delegate* in the context DRS. *Delegate* is neutral (delegates can be either female or male), so the presupposition can be satisfied by accommodating $fem(x)$ to the context DRS. Presupposition resolution is recorded as $y = x$ in the non-presuppositional part of the preliminary DRS and, in the final step, merging the non-presuppositional part of the DRS for the second sentence in (29) with the (updated) context DRS established by the first sentence results in:

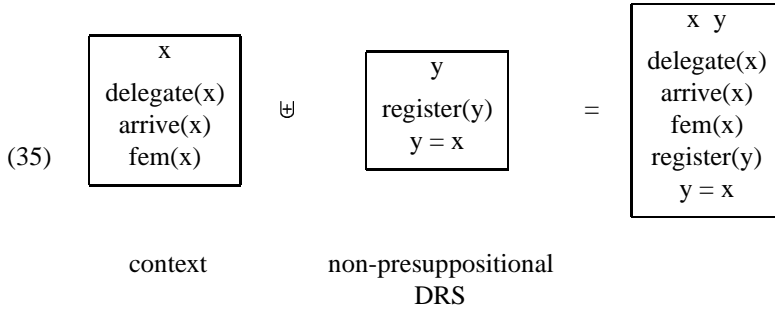

Presupposition verification in (34) involves a “world knowledge” inference corresponding to an axiom of the form $\forall x(\text{delegate}(x) \rightarrow (\text{male}(x) \vee_x \text{female}(x)))$.⁷ The example may seem trivial but, in general, presupposition verification may potentially draw upon open-ended knowledge. Except for the accommodated condition $fem(x)$, (35) is equivalent to the final unreducible DRS in (31) obtained via the top-down construction algorithm. Its truth conditions are those of $\exists x \exists y(\text{delegate}(x) \wedge \text{arrive}(x) \wedge fem(x) \wedge \text{register}(y) \wedge y = x)$.

presupposition ! justification
 world knowledge

Finally, we outline how example (12) *if Predro owns a donkey, he beats it* comes to be interpreted as the DRS in (23) in the bottom-up approach. The pair consisting of the empty context DRS and the preliminary DRS constructed for (12) is given in (36):

⁷ \vee_x is exclusive or: $P \vee_x Q$ iff $(P \vee Q) \wedge \neg(P \wedge Q)$.

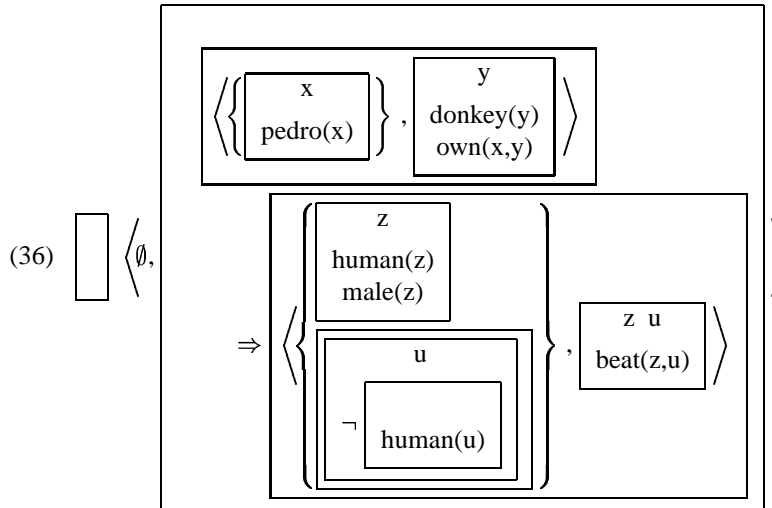

(36) is an example of a complex preliminary DRS with embedded presuppositions. The antecedent of the implicational DRS condition contains a presupposition triggered by the proper name *Pedro*. The use of the proper name *Pedro*, as opposed to, say, the phrase *someone named "Pedro"*, carries the implication that *Pedro* is already part of the available context. To do justice to this intuition, DRT assumes that the discourse referents for proper names are always part of the highest DRS universe (the highest DRS universe contains those discourse referents which represent entities that can be considered as elements of the current context of interpretation, as it has been established by the interpretation of the already processed parts of the text). Note that there is a certain tension between the claim we just made that the use of a name presupposes its bearer to be *already represented in the context*, and the stipulation that the name introduces a discourse referent representing its bearer into the context. This apparent contradiction can be easily resolved. By using the name the speaker presupposes familiarity with it, in the sense of there being a representation of its bearer. This, however, is a type of presupposition that is readily accommodated when necessary: if the bearer is not yet represented in the context as the interpreter has it, then the context is readily updated by adding a representation for the name's bearer. The discourse referent introduced by the name's current use can be identified with this representation. Processing the presupposition in the antecedent of the DRS condition in (36) results in the following representation:

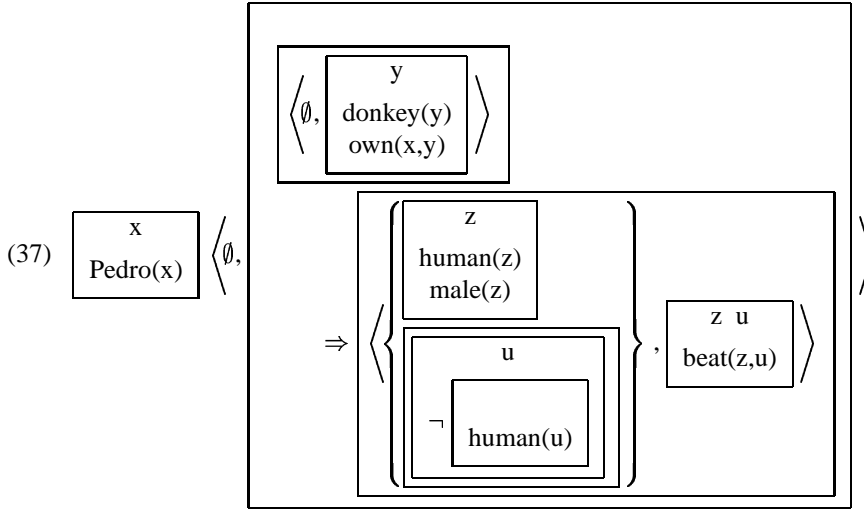

The consequent of the preliminary DRS involves two presuppositions generated by the pronominal NPs *he* and *it*. The former requires an antecedent that is human and male, the latter an antecedent that is nonhuman. Pronominal presuppositions can only be resolved through satisfaction by the local or nonlocal context, which is to say that the required antecedents will have to be provided by the context. The context available to both pronominals is provided by (i) the antecedent of the implicational condition, together with (ii) the context DRS and (iii) the discourse referents and conditions of the DRS which contains the \Rightarrow -condition as a component. (However, in the present case in which the universe of this DRS is empty, this third component of the context has no part to play.) These are precisely the domains that are accessible from the position of the consequent of the conditional, in the sense of accessibility alluded to in the description of the top-down algorithm. Also, the antecedent-presupposition triggered by the name *Pedro* has already been accommodated and the result of this accommodation added to the (previously empty) context DRS. Thus the presupposition introduced by *he* can be resolved at the level of the context DRS while the one for *it* is resolved at the level of the antecedent DRS. These resolutions match *he* with the discourse referent *x* introduced by *Pedro* and *it* with discourse referent *y* introduced by *a donkey*. These matches are recorded by $z = x$ and $u = y$, which are added to the non-presuppositional component of the consequent DRS. Again, presupposition verification involves “world-knowledge”. The resulting representation is⁸

⁸Here and elsewhere we sometimes suppress (some of) the presuppositional constraints, such as e.g.

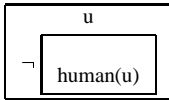

to avoid clutter in the resolved representations.

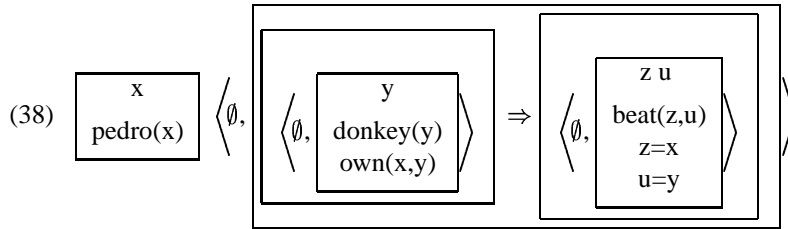

At this stage all presuppositions generated by the preliminary DRS are resolved (or cancelled) and the various (local and global) context DRSs can now be merged with the non-presuppositional components of the preliminary DRS to yield the DRS for the discourse in (12):

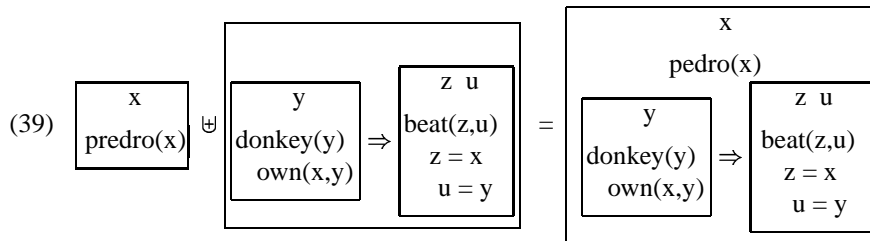

3 BASIC DRS LANGUAGES AND THEIR INTERPRETATIONS

In this section we provide formal definitions of the syntax and semantics of some basic DRS-languages. We start with a simple, extensional, first-order DRS language, present an intensional model for the language and define the notion of proposition expressed by a DRS as the set of possible worlds where the DRS is true. Truth conditions and propositions, however, do not fully capture the dynamic aspects of discourse interpretation in DRT where sentences are interpreted against a previously established context and where, in turn, a given context is updated through this interpretation into a new context for subsequent sentences. We model this dynamics semantically in terms of information states and, based on this, context change potentials (CCPs [Heim1982]), i.e. functions on, or relations between information states. The remaining parts of this section considers extensions that deal with generalized quantifiers, plurals, tense and aspect.

context change potential
CCP

3.1 A First-Order, Extensional DRS Language

Here we provide the syntax and semantics for simple, complete and proper DRSs, the final products resulting from exhaustive and successful application of either of the two DRS construction algorithms informally presented in Section (2.3). Such DRSs do not contain any reducible conditions (i.e. they are complete) or presuppositions (they are simple) and all occurrences of discourse referents are bound (they are proper).

The vocabularies of simple, first-order, extensional DRS languages consist of four disjoint sets.

DEFINITION 0.1. The vocabulary for a simple, extensional DRS language L is given by:

DRS ! vocabulary
DRS ! language

(i) a set Ref of discourse referents

Ref
discourse referent

(ii) a set $Name$ of one-place definite relation constants

$Name$
relation constants

(iii) sets Rel^n of predicate constants

Rel^n
predicate constants

(vi) a set Sym of logical symbols; for the language defined in this section this is the set $\{=, \neg, \vee, \Rightarrow\}$

Sym

In languages of this form, the work of individual constants in ordinary predicate logic is done by the unary predicates in the set $Name$. Thus, instead of an individual constant p to denote *Pedro*, $Name$ will contain a unary predicate $Pedro$ and the condition “ $Pedro(x)$ ” expresses that x represents the individual *Pedro*.

DRSs and DRS-conditions are defined by simultaneous recursion:

DRS ! condition

DEFINITION 0.2. Syntax of DRSs and DRS conditions of L :

- (i) if $U \subseteq \text{Ref}$ and Con a (possibly empty) set of conditions, then $\langle U, \text{Con} \rangle$ is a DRS
- (ii) if $x_i, x_j \in \text{Ref}$, then $x_i = x_j$ is a condition
- (iii) if $N \in \text{Name}$ and $x \in \text{Ref}$, then $N(x)$ is a condition
- (iv) if P is a n -place predicate constant in Rel and $x_1, \dots, x_n \in \text{Ref}$, then $P(x_1, \dots, x_n)$ is a condition
- (v) if K is a DRS, then $\neg K$ is a condition
- (vi) if K_1 and K_2 are DRSs, then $K_1 \vee K_2$ is a condition
- (vii) if K_1 and K_2 are DRSs, then $K_1 \Rightarrow K_2$ is a condition

The conditions specified in (ii), (iii) and (iv) are called *atomic* conditions, those specified in (v), (vi) and (vii) *complex* conditions .

Given a DRS K , $\text{FV}(K)$ denotes the set of *free discourse referents* of K .

DEFINITION 0.3. $\text{FV}(K)$, the set of free discourse referents of K , is defined by:

- (i) $\text{FV}(\langle U_K, \text{Con}_K \rangle) := (\bigcup_{\gamma \in \text{Con}_K} \text{FV}(\gamma)) - U_K$
- (ii) $\text{FV}(x_i = x_j) := \{x_i, x_j\}$
- (iii) $\text{FV}(P(x_1, \dots, x_n)) := \{x_1, \dots, x_n\}$
- (iv) $\text{FV}(\neg K) := \text{FV}(K)$
- (v) $\text{FV}(K_1 \vee K_2) := \text{FV}(K_1) \cup \text{FV}(K_2)$
- (vii) $\text{FV}(K_1 \Rightarrow K_2) := \text{FV}(K_1) \cup (\text{FV}(K_2) - U_{K_1})$

$\text{BV}(K)$, the set of *bound discourse referents* of K , is the set $\text{V}(K) \setminus \text{FV}(K)$, where $\text{V}(K)$ is the set of all discourse referents occurring somewhere in K .

A *proper* DRS is a DRS where all occurrences of discourse referents are properly bound.

DEFINITION 0.4. A DRS K is proper iff $\text{FV}(K) = \emptyset$

To define the notion of a pure DRS formally we need to make use of the relation of one DRS being a sub-DRS of another DRS. This relation, which we represent as \leq , is defined as the reflexive transitive closure of the relation $<$ of a DRS K_1 being an immediate sub-DRS of a DRS K . $<$ is given in Definition 0.5.

DEFINITION 0.5. K_1 is an immediate sub-DRS of K , $K_1 < K$, if any of the following conditions holds:

- (i) $\neg K_1 \in \text{Con}_K$

condition ! atomic

condition ! complex

$\text{FV}(K)$

discourse referent ! free

$\text{BV}(K)$

discourse referent ! bound

DRS ! proper

subordination

subordination ! immediate $<$

- (ii) there is a DRS K_2 sth. $K_1 \Rightarrow K_2 \in \text{Con}_K$ or $K_2 \Rightarrow K_1 \in \text{Con}_K$
- (iii) there is a DRS K_2 sth. $K_1 \vee K_2 \in \text{Con}_K$ or $K_2 \vee K_1 \in \text{Con}_K$

Purity of a DRS can now be defined as in Definition 0.6. A DRS is *pure* if it does not contain otiose declarations of discourse referents.

DRS ! pure

DEFINITION 0.6. A DRS K is pure iff for every two distinct DRSs K_1 and K_2 such that K_2 is a sub-DRS of K_1 and K_1 is a sub-DRS of K , $U_{K_2} \cap (U_{K_1} \cup \text{FV}(K)) = \emptyset$.

On the basis of the relation \leq we can also define a relation of accessibility, either between DRSs or between discourse referents. The accessibility relation between DRSs is given in Definition (0.7), that between between discourse referents in Definition 0.8.

Accessibility ! acc

DEFINITION 0.7. Given DRSs K and K_1 , K is accessible from K_1 , in symbols $K \text{ acc } K_1$, iff

- (i) $K_1 \leq K$; or
- (ii) there exist DRSs K_2 and K_3 , sth. $K_2 \Rightarrow K_3$ and $K \text{ acc } K_2$ and $K_3 \text{ acc } K_1$

DEFINITION 0.8. Given DRSs K , K_1 and discourse referents x and y , x is accessible from y , in symbols $x \text{ acc } y$, iff $x \in U_K$, $y \in U_{K_1}$ and $K \text{ acc } K_1$.

Models $\langle U, \mathfrak{S} \rangle$ for the simple DRS language L defined above are extensional first-order models consisting of a non-empty domain U of individuals and an interpretation function \mathfrak{S} which maps names in Name into elements in U , and n -ary relations in Rel into sets of n -tuples of elements of U , i.e. into elements of the set $\mathcal{P}(U^n)$.

DEFINITION 0.9. Interpretation functions \mathfrak{S} for models of L are defined as follows:

interpretation function
 \mathfrak{S}

- (i) $\mathfrak{S} : \text{Name} \rightarrow \{\{u\} | u \in U\}$
- (ii) $\mathfrak{S} : \text{Rel}^n \rightarrow \mathcal{P}(U^n)$

The model-theoretic interpretation of the core DRS language defined above can be illustrated as follows: by way of a first approximation, a DRS $K = \langle U_K, \text{Con}_K \rangle$ can be thought of as a “partial” model (this is qualified below) representing the information conveyed by some discourse D ; K is true if and only if K can be embedded into the “total” model $\mathcal{M} = \langle U, \mathfrak{S} \rangle$ by mapping all the discourse referents in the universe U_K of K into elements in the domain U of \mathcal{M} in such a way that under this mapping all the conditions $\gamma \in \text{Con}_K$ come out true in \mathcal{M} . In other words, K is true if and only if there is a homomorphism from K into \mathcal{M} . In DRT parlance, such a homomorphism is called a *verifying embedding for K into*

\mathcal{M} . Embeddings are *partial* variable or discourse referent⁹ assignment functions and the notation $g \subseteq_X k$, where X is a (possibly empty) set of discourse referents, states that embedding k extends g to the discourse referents in X , i.e. $\text{Dom}(k) = \text{Dom}(g) \cup X$.¹⁰

embedding ! verifying
embedding ! partial

The conception of a DRS K as a partial model makes straightforward sense only in those cases where all conditions of K are atomic. As soon as the DRS contains complex conditions, of the form (21), say, or of the form (22), the notion becomes problematic for the very same reasons that negation and implication are problematic in Situation Semantics ([Cooper *et al.* 1990, Barwise *et al.* 1991, Barwise and Cooper 1993]). Take negation: should the condition

Situation Semantics

$$(40) \quad \neg \begin{array}{|c|} \hline y \\ \hline \text{donkey}(y) \\ \text{own}(x,y) \\ \hline \end{array}$$

be understood as giving partial information in the sense that (the value of) x does not own any of the donkeys that can be found in some limited set or should it be taken as an absolute denial that x owns any donkeys whatever? The view adopted by classical DRT is that (40) is to be interpreted absolutely, in the sense that an embedding (assignment) f with $f(x)=a$ into a model $\mathcal{M} = \langle U, \mathfrak{S} \rangle$ verifies (40) iff there is no $b \in U$ such that $b \in \mathfrak{S}(\text{donkey})$ and $\langle a, b \rangle \in \mathfrak{S}(\text{own})$; or to put it into slightly different terms, and assuming that f is not defined for y : f verifies (40) in \mathcal{M} iff there is *no* function g such that $f \subset_{\{y\}} g$ (i.e. no extension g of f such that $\text{Dom}(g) = \text{Dom}(f) \cup \{y\}$) which verifies (41) in \mathcal{M} .

embedding
assignment

extension
 $\subset_{\{y\}}$

$$(41) \quad \begin{array}{|c|} \hline y \\ \hline \text{donkey}(y) \\ \text{own}(x,y) \\ \hline \end{array}$$

A similar verification clause is adopted for complex conditions of the form $K_1 \Rightarrow K_2$, where $K_1 = \langle U_{K_1}, \text{Con}_{K_1} \rangle$ and $K_2 = \langle U_{K_2}, \text{Con}_{K_2} \rangle$ are DRSs. $K_1 \Rightarrow K_2$ is verified by f in \mathcal{M} iff for *every* g such that $f \subset_{U_{K_1}} g$ which verifies the conditions in K_1 there *exists* an h such that $g \subset_{U_{K_2}} h$ and h verifies the conditions in K_2 . Putting these considerations together we come to the following definitions of verification and truth:

verification
truth
embeddings ! verifying

DEFINITION 0.10. Verifying embeddings for DRSs and DRS conditions of L:

- (i) $\langle g, h \rangle \models_{\mathcal{M}} \langle U, \text{Con} \rangle$ iff $g \subset_U h$ and for *all* $\gamma \in \text{Con}$: $h \models_{\mathcal{M}} \gamma$
- (ii) $g \models_{\mathcal{M}} x_i = x_j$ iff $g(x_i) = g(x_j)$

⁹We often use the terms “variable” and “discourse referent” interchangeably.

¹⁰Below we use $g \subseteq_X k$ and $k \supseteq_X g$ interchangeably.

- (iii) $g \models_{\mathcal{M}} N(x)$ iff $\mathfrak{S}(N) = \{g(x)\}$
- (iv) $g \models_{\mathcal{M}} P(x_1, \dots, x_n)$ iff $\langle g(x_1), \dots, g(x_n) \rangle \in \mathfrak{S}(P)$
- (v) $g \models_{\mathcal{M}} \neg K$ iff there does *not exist* an h such that $\langle g, h \rangle \models_{\mathcal{M}} K$
- (vi) $g \models_{\mathcal{M}} K_1 \vee K_2$ iff there is *some* h such that $\langle g, h \rangle \models_{\mathcal{M}} K_1$ or there is *some* h such that $\langle g, h \rangle \models_{\mathcal{M}} K_2$
- (vii) $g \models_{\mathcal{M}} K_1 \Rightarrow K_2$ iff for all m such that $\langle g, m \rangle \models_{\mathcal{M}} K_1$ there exists a k such that $\langle m, k \rangle \models_{\mathcal{M}} K_2$

When $g \models_{\mathcal{M}} \gamma$ where γ is a DRS condition, we say that g *verifies* γ in \mathcal{M} . When K is a DRS and $\langle g, h \rangle \models_{\mathcal{M}} K$, we say that h *verifies* K with respect to g .

verification ! DRS condition

verification ! DRS

DEFINITION 0.11. Truth of a proper DRS K in a model \mathcal{M} :

truth

A proper DRS K is true in a model \mathcal{M} iff there *exists* a verifying embedding h for K in \mathcal{M} with respect to the empty assignment Λ .

 Λ

We write: $\models_{\mathcal{M}} K$ iff there exists an h such that $\langle \Lambda, h \rangle \models_{\mathcal{M}} K$.

The definition of truth for a DRS in a model given in 0.11, together with the definition of a verifying embedding for DRSs in 0.10, ensures that the discourse referents in the universe of a main DRS (i.e. one which is not occurring as a sub-DRS of some other DRS) are interpreted as existentially quantified variables. The existential quantifier in the truth definition in 0.11 is often referred to as existential closure. Note the difference between the existential closure which the truth definition imposes on the discourse referents in the universe of a main DRS and the universal quantification imposed on the discourse referents in the antecedent of a conditional DRS condition $K_1 \Rightarrow K_2$, as shown in clause 0.10(vii). Note also the conjunctive interpretation that 0.10(i) imposes on condition sets: in order that h verifies $\langle U, \text{Con} \rangle$ (with respect to a prior embedding g) in \mathcal{M} , h must extend g to U and h must verify each of the conditions $\gamma_1, \dots, \gamma_n \in \text{Con}$ (which is equivalent to the claim that h verifies their conjunction). Thus it is an effect of 0.10(i) that conjunction is built into the structure of a DRS via its condition set, just as it follows from 0.11 that existential quantification is built into it via its universe. There is no need to represent the conjunction and existential quantification operators of classical logic by means of special devices (i.e. in the form of special complex conditions – but see the discussion of dynamic conjunction in Section 4). One consequence of this is that the DRS language in which the only complex conditions are of the form $\neg K$ has the expressive power of the full predicate calculus (for this sub-language can express \exists , \wedge and \neg , and the other logical operators of classical logic can be expressed with the help of these, cf. [Kamp and Reyle1991]).

quantifier ! existential

universe ! main

logic ! classical

The DRSs in the first order fragment as defined in 0.2 and 0.10 can be mapped straightforwardly into corresponding FOPL formulae in terms of a function $\wp\ell$ ¹¹ following the clauses in the syntactic definition 0.2 above:

DEFINITION 0.12. Translation of L into FOPL

- (i) $\wp\ell(\langle\{x_1, \dots, x_n\}, \{\gamma_1, \dots, \gamma_m\}\rangle) := \exists x_1 \dots \exists x_n (\wp\ell(\gamma_1) \wedge \dots \wedge \wp\ell(\gamma_m))$
- (ii) $\wp\ell(x_i = x_j) := (x_i = x_j)$
- (iii) $\wp\ell(N(x)) := (N = x)$ ¹²
- (iv) $\wp\ell(P(t_1, \dots, t_n)) := P(t_1, \dots, t_n)$
- (v) $\wp\ell(\neg K) := \neg(\wp\ell(K))$
- (vi) $\wp\ell(K_1 \vee K_2) := \wp\ell(K_1) \vee \wp\ell(K_2)$
- (vii) $\wp\ell(\langle\{x_1, \dots, x_n\}, \{\gamma_1, \dots, \gamma_m\}\rangle \Rightarrow K_2) := \forall x_1 \dots \forall x_n [(\wp\ell(\gamma_1) \wedge \dots \wedge \wp\ell(\gamma_m)) \rightarrow \wp\ell(K_2)]$

The definition of verifying embeddings for DRSs given in 0.10 can be regarded as the definition of a relation between partial input and output assignments on discourse referents - the relation which holds between an output assignment o and an input assignment i relative to a model \mathcal{M} and DRS K if o extends i and verifies the conditions of K in \mathcal{M} . In the light of this, the input assignment i may be seen as potentially verifying K in \mathcal{M} if it has one or more extensions o verifying the conditions of K in \mathcal{M} . Alternatively, verification may be seen as a non-deterministic process which transforms i into one of the possible output assignments o . The input-output view of the verification definition for DRT is very natural from the perspective of the semantics of programming languages [Harel1984]. This analogy has led to versions of the semantics of DRT which are very compact and elegant (see e.g. [Dekker1993, Muskens1996, Kohlhase *et al.*1996, Muskens *et al.*1997, Eijck and Kamp1997]) and inspired alternative approaches (such as [Groenendijk and Stokhof1991, Groenendijk and Stokhof1990]). In these versions, DRSs are interpreted as programmes consisting of sequences of instructions; some of these take the form of the introduction of a discourse referent, others the form of DRS conditions. A DRS of the form $\langle U, \text{Con} \rangle$ is one where all the instructions of the first type precede those of the second; but in this new version of DRT, any order of discourse referents and conditions is admissible (though DRSs which differ in the order of their instructions will, in general, not be equivalent, even if they involve the same set of instructions). Here

¹¹Strictly speaking in order to ensure that $\wp\ell$ is functional we have to define it for a certain canonical order on the sets of discourse referents and conditions in a given DRS. The definition given above maps a DRS into a set of equivalent FOPL formulae.

¹² N is assumed to be a first-order predicate logic constant in the right hand side of (iii) denoting the object u in the interpretation $\{u\}$ assigned to the corresponding DRT definite relation symbol on the left hand side.

we give a (star free)¹³ fragment of Quantificational Dynamic Logic (QDL, cf. [Pratt1976, Harel1984, Goldblatt1992 first edition 1987]) and show how simple first-order DRSs can be translated into QDL programmes. QDL standardly assumes total assignments so there is a *prima facie* mismatch between that semantics and the partial assignment semantics in DRT. However, so long as we restrict attention to pure DRSs the partial assignment semantics can be restated without difficulty as a semantics involving total assignments. The translation given below in Definition 0.15 preserves satisfaction. Embeddings are also possible if both QDL and DRT are defined with partial assignments, for details see e.g. [Fernando1992]. The syntax of (a fragment of) QDL formulas \mathcal{F} and programmes \mathcal{P} is defined by simultaneous recursion:

Dynamic Logic
Quantificational Dynamic Logic

DEFINITION 0.13. A QDL Syntax Fragment:

- (i) $P(t_1, \dots, t_n) \in \mathcal{F}$
- (ii) $\perp \in \mathcal{F}$
- (iii) if $\pi \in \mathcal{P}$ and $\phi \in \mathcal{F}$ then $[\pi]\phi \in \mathcal{F}$
- (iv) $x := ? \in \mathcal{P}$
- (v) if $\pi_1, \pi_2 \in \mathcal{P}$ then $\pi_1; \pi_2 \in \mathcal{P}$
- (vi) if $\phi \in \mathcal{F}$ then $\phi? \in \mathcal{P}$

Intuitively, $x := ?$ is a random assignment; $\pi_1; \pi_2$ is a sequence of programmes: first carry out π_1 , then π_2 . The postfix operator ‘?’ in (0.13vi) turns formulas into programmes. $[\pi]\phi$ is a formula stating that ϕ will be true after every terminating execution of π . The semantics of QDL is given in terms of ordinary first order models $\mathcal{M} = \langle U, \mathfrak{S} \rangle$ and total assignment functions g, i, o, \dots :

DEFINITION 0.14. QDL Semantics

- (i) $\llbracket P(t_1, \dots, t_n) \rrbracket = \{g \mid \langle \llbracket t_1 \rrbracket^g, \dots, \llbracket t_n \rrbracket^g \rangle \in \mathfrak{S}(P)\}$
- (ii) $\llbracket \perp \rrbracket = \emptyset$
- (iii) $\llbracket [\pi]\phi \rrbracket = \{g \mid \text{for all } m \text{ sth. } \langle g, m \rangle \in \llbracket \pi \rrbracket \text{ there exists } h \text{ sth. } \langle m, h \rangle \in \llbracket \phi \rrbracket\}$
- (iv) $\llbracket x := ? \rrbracket = \{\langle i, o \rangle \mid i[x]o\}$ ¹⁴
- (v) $\llbracket \phi_1; \phi_2 \rrbracket = \{\langle i, o \rangle \mid \text{there exists an } m \text{ sth. } \langle i, m \rangle \in \llbracket \phi_1 \rrbracket \text{ and } \langle m, o \rangle \in \llbracket \phi_2 \rrbracket\}$
- (vi) $\llbracket \phi? \rrbracket = \{\langle i, i \rangle \mid i \in \llbracket \phi \rrbracket\}$

¹³“*” is the iteration operator.

¹⁴Given two variable assignment functions i and o , $i[x]o$ states that o is exactly like i except possibly for the value assigned to x .

The execution of a programme may change an input state into possibly different output states. States are modelled as sets of embeddings (sets of assignments of values to variables). At a given state a formula is either true or false. The ‘?’ post-fix operator turns a formula into a test, i.e. a programme that passes on the input assignment unchanged if the assignment supports the formula in the scope of the operator; otherwise execution aborts. It is easy to see how negation $\neg\phi$ can be modelled as $[\phi?]_{\perp}$ and existential quantification $\exists x\phi$ as $\langle x = ? \rangle\phi$ where $\langle \pi \rangle\phi$ is shorthand for $\neg([\pi](\neg\phi))$. The embedding Q of pure DRSs (Definition 0.6) into QDL translates DRS conditions into formulas and DRSs into programmes as follows:

DEFINITION 0.15. DRT to QDL translation:

- (i) $Q(P(t_1, \dots, t_n)) = P(t_1, \dots, t_n)$
- (ii) $Q(\neg K) = [Q(K)]_{\perp}$
- (iii) $Q(K_1 \Rightarrow K_2) = [Q(K_1)]\langle Q(K_2) \rangle_{\top}$
- (iv) $Q([x_1, \dots, x_n \mid \gamma_1, \dots, \gamma_m]) = x_1 = ? ; \dots, x_n = ? ; Q(\gamma_1)? ; \dots ; Q(\gamma_m)?$

Working again with partial assignments (embeddings), a discourse referent x is interpreted as an instruction to extend the current assignment (the input assignment) randomly with an assignment to x while the occurrence of a condition γ functions as a check whether an assignment satisfies the constraint γ expresses. If we stick to the DRS format adopted here (as in [Kamp1981a] and [Kamp and Reyle1993]) – DRSs are pairs $\langle U, \text{Con} \rangle$ – then the input-output perspective can be brought out more prominently in the following reformulation 0.16 of 0.10:

DEFINITION 0.16.

- (o) $\llbracket x_l \rrbracket^i = i(x)$ if $x \in \text{Dom}(i)$; undefined otherwise.
- (i) $\llbracket \langle U, \text{Con} \rangle \rrbracket := \{ \langle i, o \rangle \mid i \subset_{\mathbf{U}} o \text{ and } o \in \bigcap_{\gamma_j \in \text{Con}} \llbracket \gamma_j \rrbracket \}$
- (ii) $\llbracket x_l = x_k \rrbracket := \{ i \mid \llbracket x_l \rrbracket^i \text{ and } \llbracket x_k \rrbracket^i \text{ defined and } = \llbracket x_l \rrbracket^i = \llbracket x_k \rrbracket^i \}$
- (iii) $\llbracket N(x) \rrbracket := \{ i \mid \llbracket x \rrbracket^i \text{ defined and } \llbracket x \rrbracket^i \in \mathfrak{S}(N) \}$
- (vi) $\llbracket P(x_1, \dots, x_n) \rrbracket := \{ i \mid \llbracket x_j \rrbracket^i \text{ defined for } j = 1, \dots, n \text{ and } \langle \llbracket x_1 \rrbracket^i, \dots, \llbracket x_n \rrbracket^i \rangle \in \mathfrak{S}(P) \}$
- (v) $\llbracket \neg K \rrbracket := \{ i \mid \neg \exists o \langle i, o \rangle \in \llbracket K \rrbracket \}$
- (vi) $\llbracket K_1 \vee K_2 \rrbracket := \{ i \mid \exists o \langle i, o \rangle \in \llbracket K_1 \rrbracket \text{ or } \exists o \langle i, o \rangle \in \llbracket K_2 \rrbracket \}$
- (vii) $\llbracket K_1 \Rightarrow K_2 \rrbracket := \{ i \mid \forall o \langle i, o \rangle \in \llbracket K_1 \rrbracket \rightarrow \exists k \langle o, k \rangle \in \llbracket K_2 \rrbracket \}$

In 0.16 DRS conditions are interpreted as sets of assignments. In other words, they are “externally static” and do not pass on updated assignments to other conditions. Conditions act as tests on the current assignment and pass on the assignment unchanged if it verifies the condition. One condition, $K_1 \Rightarrow K_2$, is “internally dynamic”. The (possibly updated) output assignments of the antecedent of implicative conditions are passed on as input assignments to the consequent DRS.

In this format, DRS sequencing $K_1 ; K_2$ can easily be defined as relational composition: DRS ! sequencing

DEFINITION 0.17. DRS sequencing

$$(i) \llbracket K_1 ; K_2 \rrbracket := \{ \langle i, o \rangle \mid \exists m (\langle i, m \rangle \in K_1 \wedge \langle m, o \rangle \in K_2) \}^{15}$$

The relationship between DRT and models of computation has also been explored extensively within the framework of constructive/intuitionistic type theory [Martin-Löf1984]. We refer the reader to [Ahn and Kolb1990, Ranta1995, Fernando2001b, Fernando2001a] Type Theory ! constructive
Type Theory ! intuitionistic

3.2 *Intensional Semantics, Propositions, Information States and Context Change Potential*

Traditionally, the aim of model theoretic semantics has been to explicate meaning in terms of conditions of truth and reference. Often this goal is implemented via a two-step procedure: expressions of the object language (e.g. some fragment of English) are assigned a logical form or “semantic representation” - an expression belonging to some formal language. The model theoretic definition of truth conditions is then given directly for these semantic representations or logical forms. The truth conditions of an expression of the object language are in that case the truth conditions of the formal expressions assigned to it. This two-step procedure is reminiscent of DRT where we also assign formal representations (viz. DRSs) to bits of natural language and then state the truth definition as applying to DRSs. DRSs are assigned truth conditions, and the truth conditions of a DRS are to be understood as the truth conditions, and thus as the propositional content, of the bit of language it represents. But DRSs do more: they not only represent propositional content, but also provide the context against which new sentences in a discourse are interpreted. In DRT every new sentence in a discourse contributes to and in turn is interpreted against a continually evolving context. This new conception of meaning as context update and interpretation in context is the hallmark of “dynamic” semantics, which DRT and other early dynamic semantic theories such as File semantics ! intensional
propositions
information states

¹⁵It is important to distinguish the DRS sequencing operation “;” from that of the merge of two or more DRSs. The merge $K_1 \uplus K_2$ of two DRSs is the DRS $\langle U_{K_1} \cup U_{K_2}, \text{Con}_{K_1} \cup \text{Con}_{K_2} \rangle$. Similarly, if \mathcal{K} is a set of DRSs, then $\uplus \mathcal{K} = \langle \cup \{ U_K \mid K \in \mathcal{K} \}, \cup \{ \text{Con}_K \mid K \in \mathcal{K} \} \rangle$. Merge, unlike DRS sequencing, is a symmetric operation which obliterates any order between or among its arguments. It is an operation which is often useful in DRT, but it is alien to the dynamic perspective of QDL.

Change Semantics [Heim1982] initiated. One aspect of the contextual dependence of sentences in a cohesive text or dialogue is that in the bottom-up processing architecture the DRS constructed from a sentence which comes somewhere in the middle of a text will often be *improper*: it will contain occurrences of discourse referents which are free in the DRS itself (but belong to the universe of the context DRS; this happens whenever an anaphoric pronoun gets resolved in context, cf. examples (35), (39) and (43)). In these cases, it is only the merge of the new DRS with the context DRS to which the verification definition 0.10 and the truth definition 0.11 assign well defined truth conditions. The question that naturally arises at this point is: can we explicate the way in which the new sentence updates the context in which it is interpreted, in model theoretic terms, viz. by assigning it a function which maps the truth conditions of the context DRS to those of its update? When we move from an extensional model theory, of the kind we have assumed up to now, to an intensional one, in which it is possible to assign to every (proper) DRS the proposition (set of worlds) it expresses, then we can rephrase the above question as follows: can we associate with each improper DRS K a function CCP from propositions to propositions such that, if P_c is the proposition expressed by a context DRS K_c , then $CCP_K(P_c)$ is the proposition expressed by the updated context, obtained through merging K_c with K ? The answer to this question is negative. But it is nevertheless possible to achieve something that comes reasonably close to a positive answer: we can ‘refine’ the notion of the proposition expressed by a proper DRS K_c to that of the *information state* described by K_c , and can then assign to improper DRSs K update functions CCP_K from information states to information states [Heim1982], such that if \mathcal{I}_c is the information state described by the context DRS K_c and CCP_K is the update function determined by K , then $CCP_K(\mathcal{I}_c)$ is the information state of the merge of K_c and K .

Below, we first present a simple, intensional semantics for the DRS language L defined in 0.2. We define the proposition expressed by a DRS K relative to \mathcal{M} as the set of all possible worlds in \mathcal{M} where K is true. We show that a simple version of CCP based on propositions is too coarse-grained to capture anaphoric dependencies (42), introduce the richer notion of information states and present a version of the CCP based on these.

To avoid certain notorious difficulties with existence and the denotation of names, we base the intensional model theory for the simple DRS language in 0.2 on models where all worlds come with the same universe (set of individuals) and where names denote once and for all (each name N denotes the same individual in every world of the model). Relations, however, are interpreted relative to particular worlds. We further assume that the accessibility relation between possible worlds is the universal relation (i.e. each world is accessible to itself and to each other world). An intensional model \mathcal{M} is then defined as a triple $\langle W_{\mathcal{M}}, U_{\mathcal{M}}, \mathfrak{S}_{\mathcal{M}} \rangle$ as follows:

DEFINITION 0.18. An *intensional model* \mathcal{M} is given by $\langle W_{\mathcal{M}}, U_{\mathcal{M}}, \mathfrak{S}_{\mathcal{M}} \rangle$, where:

DRS ! improper

context change potential

world ! possible
accessible

- (i) $W_{\mathcal{M}}$ is a set of possible worlds
- (ii) $U_{\mathcal{M}}$ is a non-empty set
- (iii) – for names, $\mathfrak{S}_{\mathcal{M}} : \text{Name} \rightarrow \{\{d\} \mid d \in U_{\mathcal{M}}\}$
 – for n -ary relations, $\mathfrak{S}_{\mathcal{M}} : \text{Rel}^n \rightarrow (W_{\mathcal{M}} \rightarrow \mathcal{P}(U^n))$

Verifying embeddings are defined globally, i.e. for some $X \subseteq \text{Ref}$, a verifying embedding g is defined as $g : X \rightarrow U_{\mathcal{M}}$ (and this assignment is understood as holding for all worlds, cf. clauses (ii)-(iv) of Defn. 0.19). An intensional semantics for DRSs and DRS conditions of L can now be defined as follows:

DEFINITION 0.19. Intensional semantics for DRSs and DRS conditions of L:

semantics ! intensional

- (i) $\langle g, h \rangle \models_{\mathcal{M}, w} \langle U, \text{Con} \rangle$ iff $g \subseteq_U h$ and for all $\gamma \in \text{Con}$: $h \models_{\mathcal{M}, w} \gamma$
- (ii) $g \models_{\mathcal{M}, w} x_i = x_j$ iff $g(x_i) = g(x_j)$
- (iii) $g \models_{\mathcal{M}, w} N(x)$ iff $\{g(x)\} = \mathfrak{S}(N)$
- (iv) $g \models_{\mathcal{M}, w} P(x_1, \dots, x_n)$ iff $\langle g(x_1), \dots, g(x_n) \rangle \in \mathfrak{S}(P)(w)$
- (v) $g \models_{\mathcal{M}, w} \neg K$ iff there does not exist an h such that $\langle g, h \rangle \models_{\mathcal{M}, w} K$
- (vi) $g \models_{\mathcal{M}, w} K_1 \vee K_2$ iff there is some h such that $\langle g, h \rangle \models_{\mathcal{M}, w} K_1$ or there is some h such that $\langle g, h \rangle \models_{\mathcal{M}, w} K_2$
- (vii) $g \models_{\mathcal{M}, w} K_1 \Rightarrow K_2$ iff for all m such that $\langle g, m \rangle \models_{\mathcal{M}} K_1$ there exists a k such that $\langle m, k \rangle \models_{\mathcal{M}, w} K_2$

A proper DRS K is true in \mathcal{M} at a world w ($\models_{\mathcal{M}, w} K$) iff there exists an embedding h of U_K such that $\langle \Lambda, h \rangle \models_{\mathcal{M}, w} K$. Given a model \mathcal{M} , the proposition $\llbracket K \rrbracket_{\mathcal{M}}^p$ expressed by a DRS K can now be defined as the set of all possible worlds in \mathcal{M} in which K is true.

truth
proposition

DEFINITION 0.20. Given a proper DRS K , the proposition $\llbracket K \rrbracket_{\mathcal{M}}^p$ expressed by K relative to \mathcal{M} is defined as:

$$\llbracket K \rrbracket_{\mathcal{M}}^p := \{w \mid \models_{\mathcal{M}, w} K\}$$

The intensional semantics for DRT makes it possible to extend the repertoire of complex DRS conditions with intensional conditions whose verification at a world w may depend on the verification of the constituent DRSs at worlds other than w . Simple examples are conditions of the form $\Box K$ (“it is necessary that K ”) and $\Diamond K$ (“it is possible that K ”), where K is a DRS. This extends L to a modal DRS language L_{\Box} . Within the present intensional semantics we can state verification conditions for such DRS conditions which reflect Leibnitz’ principle that necessary truth is truth in all possible worlds (while possible truth is truth in at least one possible world):

condition ! intensional

\Box

\Diamond

world ! possible

DEFINITION 0.21. Verification of modal DRS conditions of L_{\Box} in \mathcal{M} :

- (i) $g \models_{\mathcal{M},w} \Box K$ iff for all $w' \in W_{\mathcal{M}}$, $g \models_{\mathcal{M},w'} K$
- (ii) $g \models_{\mathcal{M},w} \Diamond K$ iff for some $w' \in W_{\mathcal{M}}$, $g \models_{\mathcal{M},w'} K$

Intensional models can also be used to formulate a semantics for DRSs that is dynamic in a somewhat different (and some say: stronger) sense than the versions given above. In DRT the construction of a semantic representation takes the form of an evolving context DRS where new pieces of discourse are interpreted against the available context and in turn update this context to a new context for the further following pieces to come. Given an already constructed context DRS $K_{1,\dots,n}$ for the first n sentences in a discourse, it is attractive to conceive of the dynamic semantic value of a DRS K_{n+1} for the next sentence S_{n+1} as transforming the semantic value $\llbracket K_{1,\dots,n} \rrbracket$ of the current context DRS into the new semantic value $\llbracket K_{1,\dots,n+1} \rrbracket$ for the extended context DRS $K_{1,\dots,n+1}$ which includes the information contributed by S_{n+1} . On this view, the semantic value of K_{n+1} would be a function from $\llbracket K_{1,\dots,n} \rrbracket$ to $\llbracket K_{1,\dots,n+1} \rrbracket$. The question is: what should these semantic values be? DRSs are associated with truth conditions and, given an intensional model, these, in their turn, define the proposition expressed by a DRS as the set of worlds where the DRS is true. Thus it might be tempting to build a dynamic semantics for DRT by defining the dynamic value of a DRS K_{n+1} as an operator which transforms the proposition expressed by the old context $K_{1\dots n}$ into the proposition expressed by the new context $K_{1\dots n+1}$. Formally this will give us, for each DRS K and model \mathcal{M} , a set of pairs of propositions relative to \mathcal{M} : where $\text{Prop}_{\mathcal{M}} = \mathcal{P}(W_{\mathcal{M}})$, $\llbracket K \rrbracket_{\mathcal{M}}^d \subseteq \text{Prop}_{\mathcal{M}} \times \text{Prop}_{\mathcal{M}}$. Note that such operators can only *add* information: for all K and $P \in \text{Prop}_{\mathcal{M}}$, $\llbracket K \rrbracket_{\mathcal{M}}^d(P) \subseteq P$.

This view may seem attractive as it attempts to explicate dynamic semantic values $\llbracket \cdot \rrbracket^d$ in terms of standard static semantic values $\llbracket \cdot \rrbracket^p$. There are, however, many examples (cf. (2) and (3)) that show that truth conditions alone (and dynamic semantic values based on functions from propositions to propositions) are insufficient to capture the dynamic meaning of semantic representations. Here we present a variant of a famous example due to Barbara Partee to illustrate the point

- (42) (i). Exactly nine of the ten coins are in the bag and exactly one of the ten marbles is not. It is under the sofa.
- (ii). Exactly nine of the ten marbles are in the bag and exactly one of the ten coins is not. It is under the sofa.

The DRSs for the first sentences in (42)(i) and (ii) are truth conditionally equivalent, i.e. they determine the same proposition. However, interpretation of the second sentence of (42.i,ii) in the context provided by the first sentence of (i) yields different results compared to its interpretation in the context provided by the first sentence of (ii). In (i) “It” refers to the missing marble, in (ii) to the missing coin.¹⁶

¹⁶Partee’s original example was:

Intuitively (as in examples (2) and (3)) the crucial difference between the first sentences of (42)(i) and (ii) above is not one of truth conditions but concerns which antecedents are made available for anaphoric reference in the following sentence.

In order to capture this difference, we need a more fine-grained notion of context than truth conditions and propositions provide. For the simple DRS fragment introduced up to now, the notion of an Information State [Heim1982, Groenendijk and Stokhof1990] provides the required granularity. For a proper DRS K and an intensional model \mathcal{M} , the information state $\llbracket K \rrbracket_{\mathcal{M}}^s$ records not just the worlds $w \in W_{\mathcal{M}}$ where K is true, but also the verifying embeddings f that make K true in w :

DEFINITION 0.22. Given a proper DRS K , the *information state* $\llbracket K \rrbracket_{\mathcal{M}}^s$ expressed by K relative to an intensional model \mathcal{M} is defined as:

$$\llbracket K \rrbracket_{\mathcal{M}}^s := \{ \langle w, f \rangle \mid \langle \Lambda, f \rangle \models_{\mathcal{M}, w} K \}$$

information state

Intuitively, verifying embeddings f for a given context DRS K record which discourse referents are available in the universe U_K as antecedents for anaphoric expressions occurring in sentences that are interpreted in the context of K . The embedding functions f occurring in the information state $\mathcal{I} = \llbracket K \rrbracket_{\mathcal{M}}^s$ expressed by a DRS K in \mathcal{M} will all have the same domain, viz. U_K : if $\langle w, f \rangle \in \mathcal{I}$, then $\text{Dom}(f) = U_K$. We adopt this as a general constraint on information states (irrespective of whether they are the denotation of some DRS): for each information state \mathcal{I} there is a set X of discourse referents such that for all $\langle w, f \rangle \in \mathcal{I}$, $\text{Dom}(f) = X$. X is called *the base of \mathcal{I}* and denoted as $X_{\mathcal{I}}$. Given a DRS K , the proposition $\llbracket K \rrbracket_{\mathcal{M}}^p$ defined by K (i.e. the set of possible worlds in which K is true) can be recovered from the information state $\llbracket K \rrbracket_{\mathcal{M}}^s$: $\llbracket K \rrbracket_{\mathcal{M}}^p = \{ w \mid \exists f \langle w, f \rangle \in \llbracket K \rrbracket_{\mathcal{M}}^s \}$. It is clear that the mapping from information states to propositions is many to one: two sentences (such as the first sentences in (42.i) and (42.ii)) can express the same proposition but two different information states. Unlike propositions, information states record which discourse referents are provided by a context as potential antecedents for anaphoric NPs from sentences interpreted in this context.

embedding ! verifying

proposition

DEFINITION 0.23. Given an intensional model \mathcal{M} , a DRS K and a set of discourse referents X we define

- (i) \mathcal{I} is an *information state relative to \mathcal{M} and X* iff $\mathcal{I} \subseteq \{ \langle w, f \rangle \mid \text{Dom}(f) = X \wedge \text{Ran}(f) \subseteq U_{\mathcal{M}} \wedge w \in W_{\mathcal{M}} \}$
- (ii) \mathcal{I} is an *information state relative to \mathcal{M}* iff there is an X such that \mathcal{I} is an information state relative to \mathcal{M} and X
- (iii) when \mathcal{I} is an *information state relative to \mathcal{M} and X* , X is called the *base of \mathcal{I}* , and will sometimes be denoted as $X_{\mathcal{I}}$

(i) Exactly one of the ten marbles is not in the bag. It is under the sofa.

(ii) Exactly nine of the ten marbles are in the bag. It is under the sofa.

Here *it* is interpretable as referring to the missing marble in (i) but not in (ii).

- (iv) the empty information state $\Lambda_{\mathcal{M}}^{\mathcal{I}}$ relative to \mathcal{M} , $\Lambda_{\mathcal{M}}^{\mathcal{I}} := \{\langle w, \emptyset \rangle \mid w \in W_{\mathcal{M}}\}$
 (v) the *proposition* $\text{Prop}(\mathcal{I})$ determined by \mathcal{I} : $\text{Prop}(\mathcal{I}) := \{w \mid \exists f \langle w, f \rangle \in \mathcal{I}\}$

Given a context DRS K_i and a DRS K for a sentence interpreted in the context represented by K_i resulting in a new context K_o , the dynamic semantic value (i.e. the CCP) associated with K should transform the input context K_i to the output context K_o which results from updating K_i with K . K need not be a proper DRS as illustrated in the following example:

John owns a donkey. It loves him.

$$(43) \quad \begin{array}{|c|} \hline x \ y \\ \hline \text{John}(x) \\ \text{donkey}(y) \\ \text{own}(x,y) \\ \hline \end{array} \quad \uplus \quad \begin{array}{|c|} \hline z \ u \\ \hline \text{love}(u,z) \\ z = x \\ u = y \\ \hline \end{array} \quad = \quad \begin{array}{|c|} \hline x \ y \ z \ u \\ \hline \text{John}(x) \\ \text{donkey}(y) \\ \text{own}(x,y) \\ \text{love}(u,z) \\ z = x \\ u = y \\ \hline \end{array}$$

K_i K K_o

The context DRS K_i is a proper DRS but the DRS K is not since it contains occurrences of x and y free in K . K is anaphorically resolved in that equations $z = x$ and $u = y$ record with which antecedent discourse referents provided by the context DRS K_i the discourse referents z, u introduced into K by the anaphoric pronouns *it* and *him* are identified. But, as a consequence, K is not proper.

In the present case K can serve as an update of the context DRS K_i because the merge $K_i \uplus K$ of K and K_i is proper; or, put differently, because $\text{FV}(K) \subseteq U_{K_i}$ ($= X_{\llbracket K_i \rrbracket_{\mathcal{M}}^s}$ for any model \mathcal{M}). This last condition is the key to the general principle underlying the characterization of the CCP of a DRS K in relation to a model \mathcal{M} : this should be a function that is defined on those information states \mathcal{I} relative to \mathcal{M} such that $\text{FV}(K) \subseteq X_{\mathcal{I}}$, and which in particular assigns to each such \mathcal{I} which is of the form $\llbracket K_i \rrbracket_{\mathcal{M}}^s$ the information state expressed by $K_i \uplus K$ as value. Generalising to arbitrary information states (i.e. abstracting away from the condition that \mathcal{I} is expressed by some context DRS K_i) we get the following definition:

DEFINITION 0.24. The *Context Change Potential* (or the dynamic semantic interpretation) $\llbracket K \rrbracket_{\mathcal{M}}^d$ of a DRS K relative to a model \mathcal{M} is defined as a partial function from information states to information states such that :

- (i) $\llbracket K \rrbracket_{\mathcal{M}}^d$ is defined for those information states \mathcal{I} relative to \mathcal{M} such that $\text{FV}(K) \subseteq X_{\mathcal{I}}$
 (ii) if $\mathcal{I}_i \in \text{Dom}(\llbracket K \rrbracket_{\mathcal{M}}^d)$, then $\llbracket K \rrbracket_{\mathcal{M}}^d(\mathcal{I}_i) = \{\langle w, g \rangle \mid \exists f (\langle w, f \rangle \in \mathcal{I}_i \wedge \langle f, g \rangle \models_{\mathcal{M}, w} K)\}$

For the example in (43) it is easy to see that $\llbracket K \rrbracket_{\mathcal{M}}^d(\llbracket K_i \rrbracket_{\mathcal{M}}^s) = \llbracket K_o \rrbracket_{\mathcal{M}}^s$, i.e. applying the dynamic semantic value associated with K to the information state expressed by K_i for the first sentence yields the information state expressed by K_o , the DRS representing the two sentences of (43) together.

Note that in case K is a proper DRS, $\llbracket K \rrbracket_{\mathcal{M}}^d$ is a total function; put differently, if K is proper, then $\llbracket K \rrbracket_{\mathcal{M}}^d$ is defined even for the empty information state $\Lambda_{\mathcal{M}}^{\mathcal{I}}$.

Useful Notions Relating Information States and CCPs

Information states can be ordered along two different dimensions. Intuitively, given two information states \mathcal{I} and \mathcal{I}' relative to the same base X , \mathcal{I}' is at least as informative as \mathcal{I} if $\mathcal{I}' \subseteq \mathcal{I}$. On the other hand, it is possible for an information state \mathcal{I}' to be more informative than an information state \mathcal{I} , even though $\text{Prop}(\mathcal{I}') = \text{Prop}(\mathcal{I})$. For it may be that \mathcal{I}' makes more discourse referents available than \mathcal{I} , i.e. $X_{\mathcal{I}} \subset X_{\mathcal{I}'}$ and moreover that whenever $\langle w, g \rangle \in \mathcal{I}'$, then there is an $f \subseteq g$ such that $\langle w, f \rangle \in \mathcal{I}$. This last condition can be used in a general definition of the relation “carries at least as much information as”, which also applies to cases where $\text{Prop}(\mathcal{I}) \neq \text{Prop}(\mathcal{I}')$:

information state
proposition

DEFINITION 0.25. Given two information states \mathcal{I} and \mathcal{I}' , \mathcal{I}' carries at least as much information as \mathcal{I} , in symbols $\mathcal{I}' \preceq \mathcal{I}$, iff $\forall w \forall g (\langle w, g \rangle \in \mathcal{I}' \rightarrow \exists f (\langle w, f \rangle \in \mathcal{I} \wedge f \subseteq g))$

information state ! ordering

Information states can be merged. We make use of this operation in Section 5 below.

merge ! consistent

DEFINITION 0.26. Let \mathcal{M} be an intensional model and \mathcal{S} a set of information states relative to \mathcal{M} . The *consistent merge of the $\mathcal{I} \in \mathcal{S}$* , denoted $\underline{\cup}\mathcal{S}$, is the information state defined by:

$$\underline{\cup}\mathcal{S} := \{ \langle w, h \rangle \mid \text{there exists a function } F \text{ such that } \text{Dom}(F) = \mathcal{S}, \text{ for all } \mathcal{I} \in \mathcal{S}, \langle w, F(\mathcal{I}) \rangle \in \mathcal{I} \text{ and } h = \cup \{ F(\mathcal{I}) \mid \mathcal{I} \in \mathcal{S} \} \text{ is a function. } \}$$

N.B. Note that if $\underline{\cup}\mathcal{S} \neq \emptyset$, then the base of $\underline{\cup}\mathcal{S}$ is the union of the bases of the information states in \mathcal{S} , i.e. $X_{\underline{\cup}\mathcal{S}} = \bigcup_{\mathcal{I} \in \mathcal{S}} X_{\mathcal{I}}$.

When $\mathcal{S} = \{\mathcal{I}, \mathcal{I}'\}$ we also write $\underline{\cup}\mathcal{I}\mathcal{I}'$ in lieu of $\underline{\cup}\mathcal{S}$. Of particular importance are applications of consistent merge in cases where the bases of the members of \mathcal{S} are disjoint, e.g. if $\mathcal{S} = \{\mathcal{I}, \mathcal{I}'\}$ and $X_{\mathcal{I}} \cap X_{\mathcal{I}'} = \emptyset$. In such applications the requirement that h must be a function is redundant.

In general, a CCP \mathcal{J} relative to a model \mathcal{M} is a function defined on some subset of the set of all information states relative to \mathcal{M} , which returns an information state relative to \mathcal{M} for each information state in the domain. The CCPs $\llbracket K \rrbracket_{\mathcal{M}}^d$ determined by some DRS K fit this general description, but they satisfy further conditions:

(i) whether an information state \mathcal{I} belongs to the domain of such a CCP \mathcal{J} depends exclusively on its base $X_{\mathcal{I}}$. More precisely, there is a set of discourse

referents $J_{\mathcal{J}}$ such that $\mathcal{I} \in \text{Dom}(\mathcal{J})$ iff $J_{\mathcal{J}} \subseteq X_{\mathcal{I}}$. We call $J_{\mathcal{J}}$ the *referential presupposition* of \mathcal{J} .

presupposition ! referential

(ii) \mathcal{J} has a *base* $X_{\mathcal{J}}$, a set of discourse referents such that if \mathcal{J} is defined for \mathcal{I} , then $X_{\mathcal{J}(\mathcal{I})} = X_{\mathcal{I}} \cup X_{\mathcal{J}}$.

CCP ! base

(iii) \mathcal{J} is *distributive*, i.e. if \mathcal{J} is defined for \mathcal{I} , then $\mathcal{J}(\mathcal{I}) = \cup\{\mathcal{J}(\{\langle w, f \rangle\}) \mid \langle w, f \rangle \in \mathcal{I}\}$.

CCP ! distributive

CCP ! regular

We call CCPs which satisfy conditions (i) to (iii) *regular CCPs*. These informal stipulations are summarised in Definition 0.27:

DEFINITION 0.27. Let \mathcal{M} be an intensional model, \mathcal{J} a CCP relative to \mathcal{M} and $X_{\mathcal{J}}$ a set of discourse referents. \mathcal{J} is *regular with base* $X_{\mathcal{J}}$ iff

(i) for arbitrary information states \mathcal{I} relative to \mathcal{M} , $\mathcal{I} \in \text{Dom}(\mathcal{J})$ iff $X_{\mathcal{J}} \subseteq X_{\mathcal{I}}$

(ii) for $\mathcal{I} \in \text{Dom}(\mathcal{J})$, $\mathcal{I} \preceq \mathcal{J}(\mathcal{I})$

Note that if \mathcal{J} is both regular and total, then \mathcal{J} is defined on all information states relative to \mathcal{M} :

DEFINITION 0.28. Total Context Change Potential

A Context Change Potential \mathcal{J} is total iff $\mathcal{J}(\Lambda_{\mathcal{M}}^{\mathcal{I}})$ is defined.

The notion of the proposition expressed by a DRS K relative to a model \mathcal{M} and that of the information state expressed by K have so far been defined exclusively for proper DRSs. But they can be readily generalised to improper DRSs by making them dependent on assignments to the free discourse referents of the DRS. For instance, when K is a DRS and g is a map from $\text{FV}(K)$ into $U_{\mathcal{M}}$, then the proposition expressed by K in \mathcal{M} relative to g can be defined as the set of those worlds w of \mathcal{M} for which there is an $g \subseteq U_{\mathbf{K}} h$ such that $\langle g, h \rangle \models_{\mathcal{M}, w} K$ (see Definition 0.19). The notion of an information state relative to \mathcal{M} can be generalised analogously. The formal characterisations are given in the next definition.

DEFINITION 0.29. Let \mathcal{M} be an intensional model, K a possibly improper DRS, g an assignment of $\text{FV}(K)$ in \mathcal{M} . Then

proposition ! expressed by

(i) the *proposition expressed by K relative to \mathcal{M} and g* , $\llbracket K \rrbracket_{\mathcal{M}, g}^p$, is defined by $\llbracket K \rrbracket_{\mathcal{M}, g}^p = \langle w \in W_{\mathcal{M}} \mid (\exists h)(g \subseteq U_{\mathbf{K}} h \wedge \langle g, h \rangle \models_{\mathcal{M}, w} K) \rangle$

information state ! expressed by

(ii) the *information state expressed by K relative to \mathcal{M} and g* , $\llbracket K \rrbracket_{\mathcal{M}, g}^s$, is defined by $\llbracket K \rrbracket_{\mathcal{M}, g}^s = \{\langle w, f \rangle \mid g \subseteq U_{\mathbf{K}} f \wedge \langle g, f \rangle \models_{\mathcal{M}, w} K\}$

For DRSs K from the extensional DRS-languages we have so far considered there is a close relation between $\llbracket K \rrbracket_{\mathcal{M}}^d$ and $\llbracket K \rrbracket_{\mathcal{M}, g}^s$. Suppose that \mathcal{I} is an information state in the domain of $\llbracket K \rrbracket_{\mathcal{M}}^d$ and that $\langle w, g \rangle \in \mathcal{I}$. Then we have for any f such that $g \subseteq U_{\mathbf{K}} f$:

$$(44) \langle w, f \rangle \in \llbracket \mathbf{K} \rrbracket_{\mathcal{M}}^d(\mathcal{I}) \text{ iff } \langle w, f \rangle \in \llbracket \mathbf{K} \rrbracket_{\mathcal{M},g}^s.$$

This property is closely connected with the fact that the context change potentials defined by such DRSs are extensional in the sense described below. For any two information states \mathcal{I} and \mathcal{I}' relative to \mathcal{M} with the same base (i.e. $X_{\mathcal{I}} = X_{\mathcal{I}'}$) we say that \mathcal{I} and \mathcal{I}' coincide on $w \in W_{\mathcal{M}}$ iff $\{f \mid \langle w, f \rangle \in \mathcal{I}\} = \{f \mid \langle w, f \rangle \in \mathcal{I}'\}$.

A CCP \mathcal{J} relative to \mathcal{M} is called *extensional* iff whenever $w \in W_{\mathcal{M}}$, $\mathcal{I}, \mathcal{I}' \in \text{Dom}(\mathcal{J})$, $X_{\mathcal{I}} = X_{\mathcal{I}'}$ and \mathcal{I} and \mathcal{I}' coincide on w , then $\mathcal{J}(\mathcal{I})$ and $\mathcal{J}(\mathcal{I}')$ coincide on w . It is not hard to verify that when \mathbf{K} is a DRS from the extensional DRS language defined above (which does not contain \square and \diamond), then $\llbracket \mathbf{K} \rrbracket_{\mathcal{M}}^d$ is extensional.

context change potential ! extensional

For certain purposes it is convenient to be able to make use of λ -abstracts over DRSs. As in Intensional Higher Order Logic **[Reference HPL ?]** we admit two kinds of λ -abstraction.

higher order logic ! intensional

 λ -abstraction

- (i) extensional λ -abstraction over free discourse referents in a DRS.
- (ii) intensional abstraction denoted by the operator \wedge , which is de facto an abstraction operator over worlds.

It has proved convenient to assume that λ -abstraction over discourse referents may involve any non-empty subset $\{x_1, \dots, x_n\}$ of the free discourse referents of the DRS (rather than just a single discourse referent). The definitions follow the pattern familiar from the model theory for formalisms with abstraction operators, and as such they are unsurprising. The only complication we are facing is that we have defined several types of semantic values for the objects to which these operators apply, viz. DRSs. A similar variety of options does in principle exist for the terms which we get by applying an abstraction operator to a DRS. We limit our attention here to truth values, propositions and information states. The formal definitions are given in Definition 0.30.

DEFINITION 0.30. Let \mathcal{M} be an intensional model, \mathbf{K} a DRS and let $x_1, \dots, x_n \in \text{FV}(\mathbf{K})$.

- (a) Let $w \in W_{\mathcal{M}}$, g an assignment in \mathcal{M} on $\text{FV}(\mathbf{K}) \setminus \{x_1, \dots, x_n\}$.
 - (i) $\llbracket \lambda\{x_1, \dots, x_n\}.\mathbf{K} \rrbracket_{\mathcal{M},w,g}$ is that function from $(U_{\mathcal{M}})^n$ to truth values which is given by:
if $a_1, \dots, a_n \in U_{\mathcal{M}}$, then $\llbracket \lambda\{x_1, \dots, x_n\}.\mathbf{K} \rrbracket_{\mathcal{M},w,g}(\langle a_1, \dots, a_n \rangle) = 1$
iff $(\exists h)(g \cup \{\langle x_1, a_1 \rangle, \dots, \langle x_n, a_n \rangle\} \subseteq_{U_{\mathbf{K}}} h \wedge \langle g, h \rangle \models_{\mathcal{M},w} \mathbf{K})$
 - (ii) $\llbracket \lambda\{x_1, \dots, x_n\}.\mathbf{K} \rrbracket_{\mathcal{M},w,g}^p$ is that function from $(U_{\mathcal{M}})^n$ to propositions relative to \mathcal{M} such that for $a_1, \dots, a_n \in U_{\mathcal{M}}$:
 $\llbracket \lambda\{x_1, \dots, x_n\}.\mathbf{K} \rrbracket_{\mathcal{M},w,g}^p(\langle a_1, \dots, a_n \rangle) =$
 $\{w' \in W_{\mathcal{M}} \mid (\exists h)(g \cup \{\langle x_1, a_1 \rangle, \dots, \langle x_n, a_n \rangle\} \subseteq_{U_{\mathbf{K}}} h \wedge \langle g, h \rangle \models_{\mathcal{M},w'} \mathbf{K})\}$

(iii) $\llbracket \lambda\{x_1, \dots, x_n\}.K \rrbracket_{\mathcal{M}, w, g}^s$ is that function from $(U_{\mathcal{M}})^n$ to information states relative to \mathcal{M} such that for $a_1, \dots, a_n \in U_{\mathcal{M}}$:

$$\llbracket \lambda\{x_1, \dots, x_n\}.K \rrbracket_{\mathcal{M}, w, g}^p(\langle a_1, \dots, a_n \rangle) = \{ \langle w', f \rangle \mid w' \in W_{\mathcal{M}} \wedge g \cup \{ \langle x_1, a_1 \rangle, \dots, \langle x_n, a_n \rangle \} \subseteq_{U_{\mathbf{K}}} f \wedge \langle g, f \rangle \models_{\mathcal{M}, w'} K \}$$

(b) We consider two possible operands for the intensional abstraction operator \wedge , (i) DRSs and (ii) λ -abstracts over DRSs. Moreover, we only define the effect of \wedge as a proposition forming operator, in the following sense: If the operand is a DRS K , we consider \wedge as forming a term denoting the proposition expressed by K (relative to some assignment, when K is improper). If the operand is a λ -abstract $\lambda\{x_1, \dots, x_n\}.K$ then the result of applying \wedge is a term which denotes a propositional function, i.e. a function which for each combination of objects $a_1, \dots, a_n \in U_{\mathcal{M}}$ returns a proposition relative to \mathcal{M} as value. Again the definitions are unsurprising.

(iv) $\llbracket \wedge K \rrbracket_{\mathcal{M}, w, g} = \{ w' \mid w' \in W_{\mathcal{M}} \wedge (\exists h)(g \subseteq_{U_{\mathbf{K}}} h \wedge \langle g, h \rangle \models_{\mathcal{M}, w'} K) \}$

(v) $\llbracket \wedge \lambda\{x_1, \dots, x_n\}.K \rrbracket_{\mathcal{M}, w, g}$ is that function from $(U_{\mathcal{M}})^n$ to propositions relative to \mathcal{M} such that such that for $a_1, \dots, a_n \in U_{\mathcal{M}}$:

$$\llbracket \lambda\{x_1, \dots, x_n\}.K \rrbracket_{\mathcal{M}, w, g}^p(\langle a_1, \dots, a_n \rangle) = \{ w' \in \mathcal{M} \mid (\exists h)(g \cup \{ \langle x_1, a_1 \rangle, \dots, \langle x_n, a_n \rangle \} \subseteq_{U_{\mathbf{K}}} h \wedge \langle g, h \rangle \models_{\mathcal{M}, w'} K) \}$$

It would be possible to generalise these definitions to a full fledged Higher Order Intensional Dynamic Logic. But the generalised definitions become fairly abstract, and we have not been able to envisage much use for them in relation to the aspects of DRT discussed in this survey.

Abstraction of either kind is also possible for DRS conditions. We can reduce such applications by identifying a DRS condition γ with the DRS $\langle \emptyset, \{\gamma\} \rangle$. In later parts of this survey (in particular in Section 3.5) we will need in particular terms of the form $\wedge_{x.\gamma}$, where x is a free variable of γ . These are short for $\wedge \lambda\{x\}.\gamma$, or, more precisely, $\wedge \lambda\{x\}.\langle \emptyset, \{\gamma\} \rangle$.

3.3 Generalised Quantifiers

One of the central tenets of DRT is that certain expressions which earlier theories treat as quantifiers should not be treated in this way. In particular, indefinites, DRT claims, should not be treated as quantificational expressions, but rather as terms, and thus in a manner that aligns them more closely with definite noun phrases than with the (genuinely) quantifying NPs. What quantificational force individual occurrences of indefinites may seem to have is, it is argued, an indirect effect – a kind of side effect due to the interactions with such operators as negation or implication.

Connected with this perspective is the fact that the original DRT formalism while expressively equivalent to first order predicate logic, nevertheless differs from it importantly in the way in which its “formulas” (i.e. the DRSs) parcel the information they contain. In particular, DRT differs from first order logic in that it doesn’t make a principled distinction between sentential and quantificational operators. In fact, the original formalism didn’t have any quantifiers as such. What comes nearest to a quantifier in this system is the implication operator \Rightarrow . But even this operator is not a quantifier strictly speaking. It acts like a quantifier only when at least one of the DRSs it connects has a non-empty universe, and what kind of quantification it represents then further depends on which of those universes is non-empty: As we saw in Section 3.1, the force of an implicational condition like that in (45) is that of a plain sentential conditional if $U_1 = U_2 = \emptyset$; of a restricted universal quantifier if $U_1 \neq \emptyset$ and $U_2 = \emptyset$; of a conditionalized existential quantifier if $U_1 = \emptyset$ and $U_2 \neq \emptyset$; and of a quantificational complex in which some universal quantifiers are followed by some existential quantifiers, if $U_1 \neq \emptyset$ and $U_2 \neq \emptyset$.

DRS condition ! implicational

quantifier ! universal

quantifier ! existential

quantifier ! complex

$$(45) \langle U_1, Con_1 \rangle \Rightarrow \langle U_2, Con_2 \rangle$$

There is arguably a sense in which \Rightarrow is the universal quantifier of the original DRT formalism. For one thing it is used in the representation of the universal quantifiers that are part of the natural language fragment for which the first DRT accounts provided a systematic analysis, i.e. NPs with the determiner *every*. For instance, as discussed in Section 2, the universally quantified sentence

(46) Every farmer who uses a tractor has a neighbour with whom he shares it.

is represented as in (47).

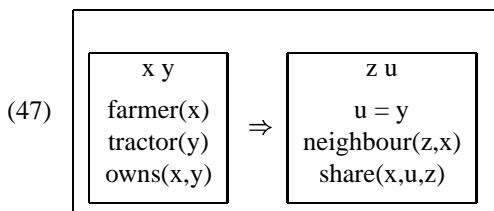

But (47) shows that even in those cases where the universe U_1 is non-empty and \Rightarrow consequently involves universal quantification of some sort, it does not quite behave like the universal quantifier of predicate logic in its standard form. Even if in addition $U_2 = \emptyset$ there still are the following two differences: (i) \Rightarrow operates on two formula-like arguments (the DRSs to the left and right of the arrow) rather than one; (ii) \Rightarrow is “unselective”, binding all the discourse referents in the universe of the first argument DRS.

(i) is in keeping with a now well-neigh universally accepted view of how quantification in natural language typically works: it involves an operator which takes two predicates as arguments, the first called its *restrictor*, and the second its (*nuclear*) *scope*. In particular, when quantification is expressed by a noun phrase such as the subject of (46), it is the common noun phrase of this NP that acts as restrictor, while the scope of the quantifier is provided by the remainder of the clause in which the NP occurs as a constituent. Structures of this sort have been studied extensively within generalised quantifier theory (see [Westerstahl1989]), in which quantifiers are analysed as *variable binding operators* – operators which bind one or more variables and whose arguments are formulas that, in the typical case, contain free occurrences of the variable or variables the operator binds. The special case of immediate interest is that represented in (48), of an operator Q which binds one variable and takes two formula-arguments.

$$(48) \quad Qx(A(x), B(x))$$

The standard interpretation of such a quantifier Q is as a relation $R(Q)$ between sets: (48) is true if the set of x 's satisfying A stands in the relation $R(Q)$ to the set of x 's satisfying B . In particular, the universal quantifier is interpreted as inclusion: if Q is the universal quantifier, then (48) is true iff the set of the A 's is included in the set of the B 's. We will see presently in what sense DRT's implication operator conforms to this analysis of universal quantification.

(ii) is more controversial. It was argued in [Lewis1975] that quantification in natural language is unselective: the quantificational operator binds whatever bindable variables turn up within its immediate scope; in principle there is no upper bound to the number of variables that a single operator can bind. Original DRT (and likewise File Change Semantics, see [Heim1982]) adopted the unselective analysis of quantification because of the attractive solution that it seems to offer to the “donkey problem” – how to account for the fact that in a sentence like (46) the indefinite *a tractor* inside the quantifying subject NP has the apparent force of a universal quantifier whose scope extends beyond the NP and includes all other sentence material (see Section 2, [Kamp1981a]).

The generalised quantifier semantics described for (48) can be naturally adapted to the case of the unselective universal “quantifier” \Rightarrow : a DRS condition governed by \Rightarrow is true if a certain set associated with the first argument (i.e. the left DRS) is included in the corresponding set associated with the second (the right DRS). But in view of the unselectiveness of \Rightarrow we need to adjust the definition of the sets.

Instead of the set of objects satisfying the first argument of \Rightarrow we must now consider the set of possible assignments of objects to all the discourse referents in the universe of the left DRS – in the case of (47) this is a set of pairs of objects $\langle a, b \rangle$, where a is assigned to the discourse referent x and b to y , and where this assignment satisfies the conditions on the left. Similarly, the second set should consist of those assignments that satisfy the first argument and which can be extended to an assignment which includes the discourse referents on the right and satisfies the second argument of \Rightarrow – in the case of (47) these are the pairs $\langle a, b \rangle$ which satisfy the conditions on the left and can be extended to tuples $\langle a, b, c, d \rangle$ with c assigned to z and d to u , which satisfy the conditions on the right. It is easily seen that (47) is true according to Def. 0.10 iff the first of these sets is included in the second.

Duplex Conditions and the Proportion Problem

It was soon noted that unselectivity leads to problems with non-universal quantifiers. This is the so-called “proportion problem” ([Kadmon1987], Chapter 10). proportion problem The problem is easiest to explain for the case of the quantifier *most*. It is quite generally held that a sentence like (49) is true if the number of farmers that are rich exceeds the number of farmers that are not rich. (More generally and formally: *Most A's are B's* is true iff the cardinality of the set $A \cap B$ is bigger than that of the set $A \setminus B$). But what are the truth conditions of sentence (50)?

(49) Most farmers are rich.

(50) Most farmers who use a tractor share it with a neighbour.

By analogy with what we have just said about (46) one would expect the following:

(51) (50) is true iff the number of assignments $\langle a, b \rangle$ to x, y which satisfy the conditions on the left of (47) and can be extended to an assignment $\langle a, b, c, d \rangle$ which satisfies the conditions on the right exceeds the number of assignments $\langle a, b \rangle$ which satisfy the conditions on the left but which cannot be so extended.

However, linguistic intuition tells us that this cannot be right; in a case where there are 19 farmers who each use just one tractor and share this tractor with some neighbour, while the 20-th farmer uses 25 tractors none of which he shares with anyone, (50) seems intuitively true (it is 19 against 1!), but the condition we have just stated predicts it to be false, as there are 19 pairs $\langle a, b \rangle$ of the first kind and 25 of the second.

The trouble with (51) is that it counts numbers of assignments (here pairs consisting of a farmer and a tractor) rather than just the numbers of farmers. What should be counted are just the satisfiers of the one variable which, in the standard generalised quantifier format (48), is bound by the quantifier. In order to correct (51) so that it conforms to this intuition, the discourse representation of (50) (and

by parity those of (46) and other quantified sentences) should mark the “bound variable” in some way, so that it can be distinguished from the other discourse referents on the left. To this end DRT has adopted the so-called duplex conditions. An example is the duplex condition representing (50), given in (52).

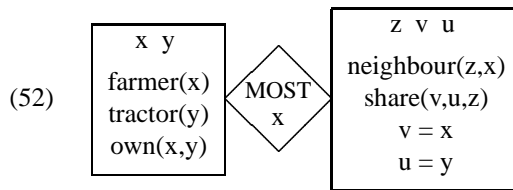

In general, a duplex condition consists of three parts, (i) the restrictor DRS, (ii) the scope DRS and (iii) the quantifier part. (i) and (ii) are as in the earlier DRT representations of quantification (cf. the left hand side DRS and right hand side DRS in 47); the quantifier part consists of a quantifier (*most*, *every*, *many*, etc.) and a discourse referent (corresponding to the bound variable in (48)).

There is one aspect of the duplex notation which requires comment. This is the simultaneous occurrence of the discourse referent x as a constituent of the quantifier part and as a member of the universe of the restrictor DRS. This two-fold occurrence could create the impression that x is bound “twice over”, something which would be logically incoherent. But this is not what is intended. Only the occurrence of x as constituent of the quantifier acts as a binding. In fact, we could eliminate the occurrence in the universe of the restrictor DRS provided we adjust the definition of accessibility (see 3.1) by stipulating that a discourse referent occurring as constituent of the quantifier part of a duplex condition acts, for the purpose of accessibility, as if it was a member of the universe of the restrictor DRS. The duplex notation exemplified in (52), in which the operator-bound discourse referent is added explicitly to the restrictor universe, obviates the need for this stipulation. The presence of this discourse referent within the quantifier part then sets it apart from the other members of the restrictor universe, in a way that is made explicit in the verification conditions for duplex conditions.

It is through its quantifier part that (52) provides us with the distinction which we need if we are to revise the truth condition (51) so that it conforms to intuition. But how should (51) be changed? This is not obvious. In fact, what exactly does (50) assert? Does it say that the majority of the farmers who use a tractor has the property that they share every tractor they use with some neighbor; or does the sentence require that there be a majority who share at least one of the tractors they use? There is surprisingly little agreement on this question, and the linguistic debate which sentences of the general form of (50) have, or prefer, the one interpretation and which the other, remains inconclusive to this day. (See [Chierchia1991], **Root XXXXX**.)

This is not the place to take sides in this debate. We only note that it has led to the names for the two readings which are now in general use; the first reading, according to which the second of the two sets consists of the farmers who share *all*

the tractors they use is called the *strong* reading (of donkey sentences); the other, according to which the set consists of farmers who share some of the tractors they use, is the *weak* reading.

doneky sentence ! strong reading

doneky sentence ! weak reading

When turning (51) into a verification condition for duplex conditions like that in (52), we must see to it that the new condition accords with our intuitions about the proportion problem; but this still leaves us both the option for the strong reading and that for the weak reading. The second option, given in (54), is formally simpler and more elegant. It can be stated as follows. Recall that each duplex condition has a restrictor DRS K_r and a scope DRS K_s , and that its quantifier part binds one discourse referent, say x . For simplicity let us assume that $FV(K_r) = \emptyset$ and that $FV(K_s) \subseteq U_{K_r}$. Define:

- (53) i. $S_r :=$ the set of all objects a such that there is an assignment h of objects to the discourse referents in the universe of K_r which assigns a to x and verifies the conditions of K_r ;
 ii. $S_s :=$ the set of all a such that there is an assignment h to the discourse referents of the universes of K_r and K_s which assigns a to x and verifies the conditions of K_r and K_s .

$$(54) \quad (52) \text{ is true iff } |S_s| > |S_r \setminus S_s|$$

The corresponding condition for the strong reading can be stated in a similar form:

$$(55) \quad (52) \text{ is true iff } |S'_s| > |S_r \setminus S'_s|$$

Superficially, this looks much like (54), but the definition of S'_s is more complex and awkward than that of S_s :

- (56) iii. $S'_s :=$ the set of all a such that (i) there is an assignment h to the discourse referents of the universe of K_r which assigns a to x and verifies the conditions of K_r and (ii) for every assignment h to the discourse referents of the universe of K_r which assigns a to x and verifies the conditions of K_r there is an assignment k to the discourse referents of the universe K_s which extends h and verifies the conditions of K_s .

Some linguists have taken the complexity of (56.iii) as an indication that the strong reading cannot be the primary interpretation of donkey sentences such as (50). (See e.g. [Chierchia1993]).

N.B. (54) and (55) come close to what is needed when duplex conditions are added to the DRS language defined in Section 3.1. But the additional truth clauses for such connectives as supplements of Def. 0.10 require a slightly more complicated form. For instance, for the weak reading of (52) the new clause is

$$(57) \quad g \models_{\mathcal{M}} K_r \begin{array}{c} \diamond \\ \text{MOST} \\ x \end{array} K_s \text{ iff } |S_s^g| > |S_r^g \setminus S_s^g|$$

where $S_r^g =$ the set of $a \in U_{\mathcal{M}}$ such that there is an assignment h such that

$g \subseteq_{U_{K_r}} h$, $h(x) = a$ and h verifies the conditions of K_r .

And analogously for S_g^g (see (53.ii).)

The truth conditions for the strong reading of duplex conditions with the operator MOST is obtained from (55) and (56) in the same way that (56) can be obtained from (53) and (54). Duplex conditions for other quantifiers will also give rise to truth conditions for either the weak or the strong reading.

Natural languages have various constructions for expressing quantification. No less prominent than quantifying noun phrases are adverbs of quantification – *always, never, often, mostly* and so on. In fact it was quantificational adverbs which led Lewis ([Lewis1975]) to his proposal of non-selective quantification; and as an analysis of adverbial quantification this proposal stands up much better than it does for quantification by means of noun phrases; adverbial quantification is much less vulnerable to objections connected with the proportion problem.

For instance, consider the adverbial analogue (58) of (50):

(58) Mostly when a farmer uses a tractor, he shares it with a neighbour.

In the scenario we considered in connection with (50), (50) itself seemed unequivocally true. But for (58) this is much less evident. Here a good case can be made for the claim that it is the numbers of farmer-tractor pairs which are to be counted, and not just the farmers.

This judgement seems to show that adverbial quantification can involve binding of several variables by the same quantifier. There has been discussion in the literature whether even these cases should be analysed as involving a single bound variable, ranging over “occasions”, or “situations”, where such occasions or situations may have several participants. (E.g. (58) would be analysed as quantifying over situations which each involve a farmer and a tractor that farmer uses.)¹⁷ In the light of the commitment we have already made to duplex conditions, in which the left hand side DRS universe may contain discourse referents besides the one which is bound by the quantifier, this debate loses much of its urgency and we will assume without further argument that quantificational binding of more than one variable is indeed possible. Thus for (58) we assume a representation of the form given in (59).

¹⁷In Section 3.5 we will consider frequency adverbs like *mostly* more closely, albeit only in their role as quantifiers over times. We have just seen that such adverbs have other uses as well – (58) is a case in point, as it need not be interpreted as a case of temporal quantification, and on its most natural interpretation it is not. Nevertheless, the analysis we will consider there of the temporal uses of such adverbs is instructive from the point at issue here. For it shows how the times t over which the quantifier ranges can serve as representations for groups individuals – those individuals which stand in a certain relationship at t .

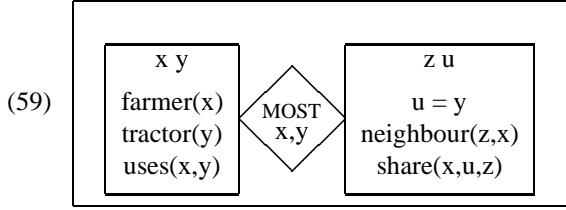

More generally, we assume that duplex conditions representing sentences with the quantifier *most*(*ly*) instantiate the following schematic form.

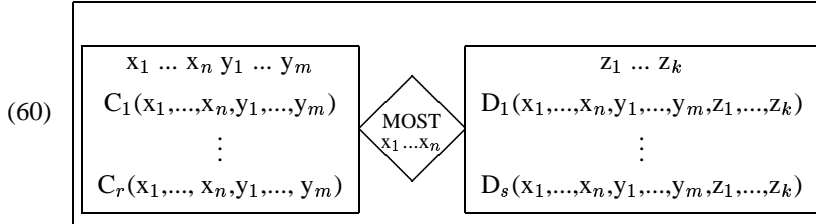

A duplex condition of the general form of (60) is verified by an embedding f iff $|S_2| > |S_1 \setminus S_2|$, where S_1, S_2 are as defined as follows:

$$\begin{aligned}
S_1 &= \{ \langle a_1, \dots, a_n \rangle \mid (\exists g)(f \subseteq_U g \wedge \bigwedge_{i=1}^n g(x_i) = a_i \wedge \\
&\quad \bigwedge_{j=1}^r g \models_{\mathcal{M}} C_j(x_1, \dots, x_n, y_1, \dots, y_m)) \} \\
&\quad \text{where } U = \{ x_1, \dots, x_n, y_1, \dots, y_m \} \\
S_2 &= \{ \langle a_1, \dots, a_n \rangle \mid (\exists g)(f \subseteq_U g \wedge \bigwedge_{i=1}^n g(x_i) = a_i \wedge \\
&\quad \bigwedge_{j=1}^r g \models_{\mathcal{M}} C_j(x_1, \dots, x_n, y_1, \dots, y_m) \wedge (\exists h)(g \subseteq_V h \wedge \\
&\quad \bigwedge_{t=1}^s h \models_{\mathcal{M}} D_t(x_1, \dots, x_n, y_1, \dots, y_m, z_1, \dots, z_k)) \} \\
&\quad \text{where } V = \{ z_1, \dots, z_k \}.
\end{aligned}$$

Even more generally, the duplex conditions may have some other operator Q occupying the position of **MOST** in (60). The truth conditions of such duplex conditions will be given by some relation between the sets S_1 and S_2 , which is denoted by Q .

The schematic form in (60) allows us to distinguish between two kinds of quantifier-related binding, that of the variables x_1, \dots, x_n and that of the variables y_1, \dots, y_m . We refer to the former kind as *primary quantificational binding* and to the latter as *secondary quantificational binding*. (We recall that the natural language examples of secondary quantificational binding we have seen so far all involve indefinite NPs in the restrictor of the quantifier represented by the central part of the duplex condition. The cases of secondary quantificational binding known to us are all of this kind.

binding ! quantificational
binding ! primary
binding ! secondary

The introduction of duplex conditions into DRT seems to bring its representation of quantification much more in line with that practiced in traditional logic than was the case for the original formulation of DRT. It should be emphasised however that the alternative possibilities of capturing quantificational effects which

make DRT in its original formulation look so very different from standard formulations of predicate logic are still there. In fact, not only do we still have the quantificational interpretation of discourse referents in the universes of DRSs in the scope of \Rightarrow , \neg , and \forall , the duplex conditions themselves incorporate this alternative source of quantificational effects as well, viz. in the form of secondary quantificational binding. The point of including duplex conditions in the DRS formalism as an additional mode of representation is that the quantification expressed by those natural language constituents which duplex conditions are used to represent is fundamentally different from the quantificational effects that are produced by indefinites within the scope of operators like negation or conditionalisation. If these different forms of quantification seem to come to the same thing within the context of standard predicate logic, this should be seen as a symptom of the exclusively truth-conditional focus of predicate logic on the one hand and of its limited expressive resources on the other. Semanticists who are interested in truth conditions only will see this kind of simplification as harmless and maybe even as desirable. But it can be harmless only for so long as the quantifiers expressible within the formalism are those definable from the standard existential and universal quantifiers of the lower predicate calculus. As we have seen in this section, even truth conditions may be affected when non-standard quantifiers (such as *most*) are taken into consideration as well.

Duplex Conditions and Generalized Quantifier Theory

A large part of the more logically oriented literature on quantifiers is concerned with their formal properties (see [Westerstahl1989, Keenan and Westerstahl1997, van der Does and van Eijck (eds.)1991]). In particular, there is a long-standing concern to identify and study those properties which single out from the set of all logically possible generalised quantifiers those that are actually found in natural languages. Especially prominent among these properties is *conservativity*: A binary relation D between sets is *conservative* iff for any sets A and B , $D(A,B)$ iff $D(A,A \cap B)$.

It is easily verified that all cases of quantification we have discussed so far (and which can be analysed as relations between sets) are conservative. In fact, conservativity is a consequence of the very way in which quantificational constructions are conceived in DRT. As first argued in Section 2.2 in connection with \Rightarrow , the antecedent of a conditional serves as context of interpretation for the consequent; and so the consequent of the conditional is to be seen as an addition of the information it explicitly provides to the information provided by the antecedent. Thus, if K_1 is the representation of the antecedent and K_2 the representation of the consequent in the context of the antecedent, the conditional comes (roughly) to the implication $K_1 \Rightarrow K_1 \uplus K_2$. Much the same applies to the DRT analysis of quantificational NPs: the material that goes into the nuclear scope of the representing duplex condition is to be interpreted in the context of the restrictor, and the nuclear scope is to be understood as addition to the restrictor. The statements of the truth conditions for

most-quantifications which was given in (51)-(57) are a direct continuation of this insofar as they take the form of relations between the sets S_1 and S_2 , corresponding to the restrictor DRS K_1 and the extension K_2 of K_1 with the material from the scope. In other words, the truth conditions associated with a duplex condition of

the form $K_1 \begin{array}{c} \diamond \\ Q \\ x \end{array} K_2$ are of the form $F_Q(S_{K_1}, S_{K_1 \uplus K_2})$ to begin with. Since

evidently $S_{K_1 \uplus K_2}$ is a subset of S_{K_1} , $F_Q(S_{K_1}, S_{K_1 \uplus K_2}) = F_Q(S_{K_1}, (S_{K_1 \uplus K_2} \cap S_{K_1}))$, the quantification represented by such a duplex condition is conservative by fiat.

Essentially the same is true for duplex conditions in which more than one discourse referent is subject to primary quantificational binding. “Conservativity” is now to be understood as a property of binary relations between n -place relations rather than sets, but the generalisation is obvious: let U be a given non-empty set, Q a 2-place relation between n -place relations over U – that is, $Q \subseteq \mathcal{P}(U^n) \times \mathcal{P}(U^n)$. Then Q is *conservative* if for all $A, B \in \mathcal{P}(U^n)$, $\langle A, B \rangle \in Q$ iff $\langle A, A \cap B \rangle \in Q$. conservative

In the literature on generalised quantifiers conservativity is only one of many quantifier properties of which the question has been raised whether all natural language quantifiers have them. But it is the only one about which the DRT analysis of natural language quantification carries immediate implications. As the discussion of other properties of quantifiers is not directly relevant from a DRT-centered perspective, this is not the place to pursue them further. We refer the reader to [Westerstahl1989], and to the other publications cited there.

Before we conclude this discussion of quantifiers representable by means of duplex conditions, we must add an observation on what has come to be recognised as a general feature of quantification in natural language. The interpretation of natural language quantifiers often involves implicit restrictions in addition to the restrictions that are explicitly expressed in the sentence itself. (And with adverbial quantifiers, where sometimes no material within the sentence itself makes a contribution to the restrictor, the implicit restrictions will make up the restrictor on their own.) Following [von Stechow1994] and many others we represent the implicit restrictions on a given quantifier by means of an additional predicate C on the quantificationally bound discourse referents. (Thus C will in general be an n -place predicate, where n is the number of discourse referents x_1, \dots, x_n involved in primary quantificational binding.) Formally the implicit restriction takes the form of a supplementary condition “ $C(x_1, \dots, x_n)$ ” in the restrictor of the duplex condition, as represented in (60). Moreover, since C has to be resolved within the context in which the quantification restricted by it occurs, we take it to give rise to a presupposition, which is included in the initial (or “preliminary”) representation as left-adjoined to the duplex condition which represents the quantification. (For the details of the DRT-based treatment that is assumed here see Section 4.) In general, this presupposition will also contain information that is relevant for the resolution

of the predicate discourse referent C (to some particular predicate). Representing this higher order constraint as $P(C)$ we get (61) as representation for the contribution made by the quantifier of a sentence, instead of the slightly simpler form exemplified in (60).

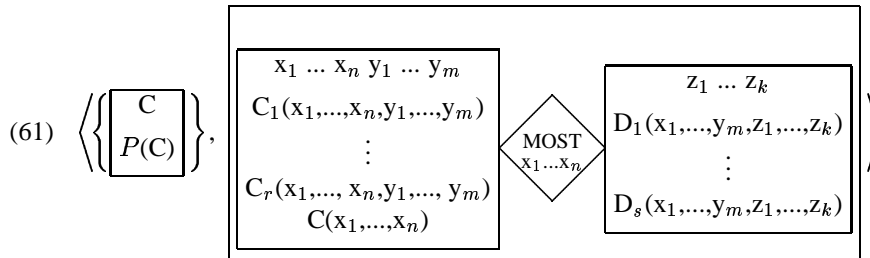

As with many other cases of presupposition the most difficult part of the theory of contextual restriction concerns the principles which govern the resolution of C . This is a problem about which we will say nothing here. We will turn to a certain aspect of this question in Section 3.5, where, as we announced already, we will consider frequency adverbs in their capacity of quantifiers over times.

Beyond Duplex Conditions

Many discussions of quantification in natural language suggest the implicit assumption that all quantifiers found in natural language are semantically like generalised quantifiers (viz. binary relations between sets, or, more generally, between n -place relations) – in our terminology, that natural quantifiers are generally to be represented in the form of duplex conditions, as schematically represented in (60) and (61). In the course of the past two decades, however, it has become increasingly apparent that this is not so: natural languages also have quantificational devices, many of them perfectly natural and even colloquial ones, which do not fit the generalised quantifier pattern ([Keenan1992]).

In the remainder of this section on quantification we discuss two examples of English quantifiers for which this is true. This is meant as a hint of how the representational approach of DRT may be extended to provide adequate representations for such forms of quantification, and also as a reminder of how much work still needs to be done in this area of natural language semantics, whether within a DRT-based framework or any other.

Our first pair of examples seems to resist representation by means of a duplex condition because it expresses a relation not between two sets, but between three.

- (62) a. Not as many women as men were drinking orange juice.
 b. More boys than girls got a present that made them happy.

(62.a) says that the set of men who drank orange juice is larger than the set of women who drank orange juice. One might want to argue that the actual quantifier

involved in this example is a binary set relation which holds between two sets A and B iff A has larger cardinality than B, that this relation can be represented in the duplex format we already adopted, and that (62.a) differs from other sentences expressing this same relation only in terms of the mapping rules which lead from syntactic structure to this representation. But the difficulties which sentences like those in (62) present are in fact more serious. Consider (62.b), in which the pronoun *them* must be construed as referring to boys on the one hand and to girls on the other. The syntactic form of (62.b) – like that of (62.a) and other sentences in which a comparative construction occurs as part of a quantifying NP – suggests that at some level of semantic representation we must have a duplex-like structure with the content of the NP occurring to the left of the quantifier part and the sentence material that expresses the predicate of which this NP is an argument occurring to the right of it:

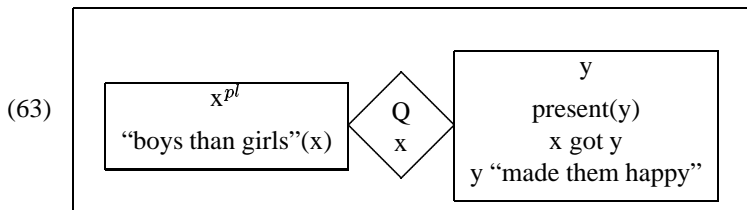

N.B. The superscript *pl* of the discourse referent x indicates that x originates from a morphologically plural NP and therefore can serve as antecedent for a plural pronoun like *they* or *them*; for discussion see Section 3.4. Furthermore we have adopted the practice of abbreviating parts of DRSs in the form of quasi-atomic DRS-conditions in which the predicate is given by an expression in scare quotes. To replace such a DRS by one that is fully worked out, these abridged conditions must be further expanded. Since the principles involved in those expansions do not matter to the point at issue, and paying attention to them would be likely to obscure it, we have decided that it is better to leave the conditions in question in the unfinished state in which they are presented. Henceforth we will proceed in this way whenever this seems expedient.

In (63) the pronoun *them* can be resolved to x if we assume that, as has been assumed for duplex conditions, the part to the left of the quantifier serves as context for the material to the right. At the same time, however, the restrictor part of (63) has to be processed in such a way that the two predicates $\lambda x.\text{boy}(x)$ and $\lambda x.\text{girl}(x)$ remain separable, so that each of them can be separately combined with the predicate in the nuclear scope. In fact, the quantifier and the comparative construction involved in the subject NP – severally represented, one might say, by the words *more* and *than* – arguably form a single semantic unit, and a single construction step should result in the four-component representation shown in (64.a). After further processing of the material in the nuclear scope (in the present example no further processing happens to be required for the material in the components left of the quantifier) this leads to (64.b). At this point two strategies seem possible.

According to the first a further processing rule turns (64.b) into (64.c). The truth conditions for (64.c) are those of the set comparison quantifier MORE: the cardinality of its first argument exceeds that of its second argument. It is important to note that while this quantifier is of the binary set relation type distinctive of standard generalised quantifiers, it is not conservative. (For instance, if A has smaller cardinality than B but larger cardinality than $A \cap B$, then $\text{MORE}(A,B)$ is false, while $\text{MORE}(A,A \cap B)$ is true.)

The second strategy is to analyse the *more* of (62) as denoting a 3-place operator, and accordingly to take (64.b) as the final semantic representation of (62.b). This 3-place operator would denote a 3-place relation MORE^3 between sets, such that $\text{MORE}^3(A,B,C)$ is true iff $|A \cap C| > |B \cap C|$. Analysed this way sentences like those in (62) can be seen to validate a certain form of conservativity: We have $\text{MORE}^3(A,B,C)$ iff $\text{MORE}^3(A,B, C \cap (A \cup B))$. This observation is in keeping with the intuition that in a sentence like (62.b) the discourse referent introduced by the subject NP can serve as antecedent for the interpretation of the material which makes up the VP, just as we have found this to be the case for those quantifying subject NPs which give rise to duplex conditions of the form given in (61).

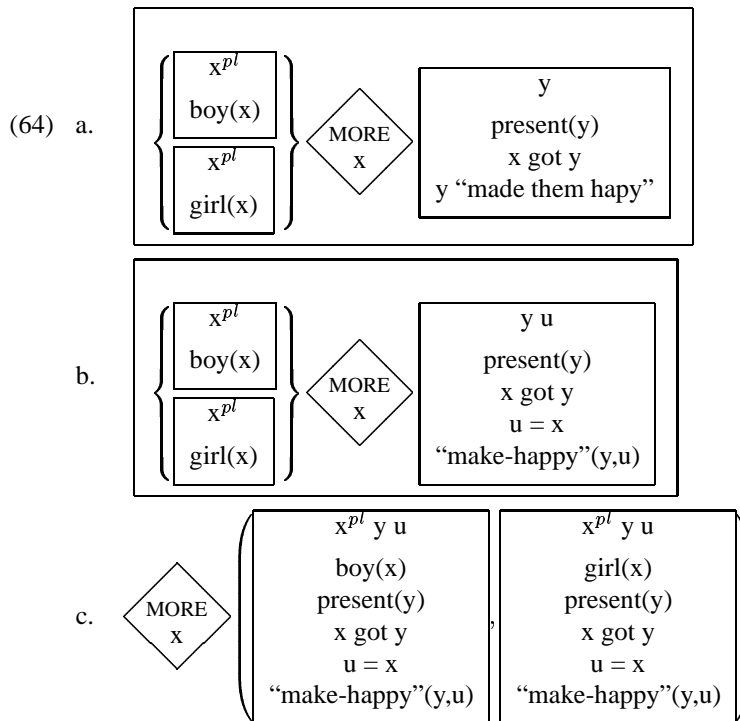

A quite different type of quantification which also does not fit the standard generalised quantifier pattern is that exemplified by (65)

(65) Every student chose a different topic.

(65) has a reading according to which it asserts (i) that every student chose a topic and (ii) that for every two different students x and y the topics chosen by x and y were distinct. It is obvious how the truth conditions associated with this reading should be written down in first order logic and, by the same token, how they can be represented in a DRS of the DRT formalism thus far developed. Such a DRS is shown in (66).

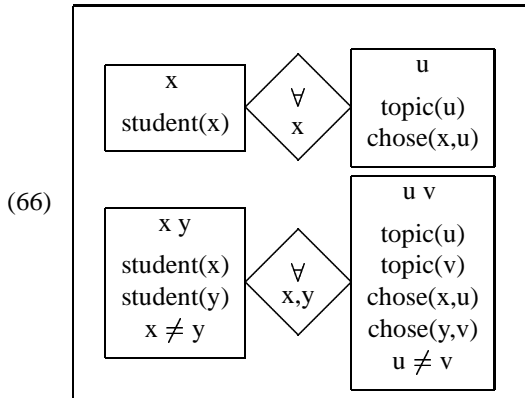

(If it is assumed that the set of students has cardinality greater than 1, then the first duplex condition of (66) becomes redundant.)

As we found in connection with the sentences in (62), the challenge presented by sentence (65) is to explain how it is possible for the syntactic form of the sentence to give rise to truth conditions like those in (66). It is intuitively clear that the element of (65) which is responsible for the complexity of these truth conditions is the adjective *different*. But this observation doesn't help us much to account for how the subject NP of (65) and its object NP in which *different* occurs can "connive" to produce such truth conditions.

The intuition that these truth conditions are due to a coordinated contribution by the two NPs, and thus that these NPs are jointly responsible for a single, undecomposable quantificational complex at the level of logical form, is especially prominent in the work of Keenan on what he calls "non-Fregean quantifiers" (viz. [Keenan1992]). Keenan analyses sentences like (65) as involving a single quantificational operation on a 2-place relation.¹⁸ The quantification is *polyadic* insofar as it binds two variables, corresponding to the two arguments of its relational operands. (In the case of (65) one of the variables corresponds to the subject NP and the other one to the object NP.) Schematically, the resulting logical form can be represented either as in (67.a), where O represents a function from 2-place relations to truth values and is applied to the 2-place relation $\lambda x.\lambda y.R(x,y)$, or as in (67.b), where O is a variable-binding operator on formulas which is applied to the

quantifier ! non-Fregean
quantifier ! polyadic

¹⁸A first treatment within DRT (and UDRT) can be found in [Seizmair1996].

formula $R(x,y)$, while binding the two variables x and y . As vehicle for the truth conditions of sentences like (65) there is little to choose between those two forms and the little we have to say applies (*mutatis mutandis*) to either.

- (67) a. $O(\lambda x.\lambda y.R(x,y))$
 b. $(Ox,y).R(x,y)$

In the case of (65) the formula in (67.b) is “ $student(x) \wedge topic(y) \wedge chose(x,y)$ ” and the relation in (67.a) is the corresponding λ -abstract. Keenan shows that the operator involved in (65), schematically represented in (67.b) and yielding the truth conditions in (66), cannot be replaced by a pair of 1-place quantifiers which are applied to this relation one after the other. This entails in particular that we cannot associate an “ordinary quantifier” – which binds one variable only – with the subject NP of (65) and another such quantifier with the object NP in such a way that the successive application of these quantifiers to the mentioned formula (or alternatively to the formula $chose(x,y)$ contributed by the verb on its own) lead to the truth conditions of (66).

While this is an important and interesting result, it doesn’t solve the syntax-semantics interface problem to which we have drawn attention. It only underscores the urgency of that problem. As it stands we do not know how this problem should be solved, and we can only venture a speculation about the direction in which a solution might be found. Consider the sentence we get by eliminating *different* from (65):

- (68) Every student chose a topic.

This sentence asserts the existence of a functional dependence of chosen topics on the students who chose them. There is substantial independent evidence (going back at last to the work of Engdahl ([Engdahl1980]) on functional wh-questions) that such functions can play a role in the interpretation of the sentences which either presuppose or entail their existence: Many sentences can be construed as making some claim about functions whose existence they entail or presuppose; and more often than not it doesn’t seem possible to account for their meaning in another way.

Our tentative proposal for the analysis of (65) now comes to this. (65) entails the existence of the function we just described in connection with (68). (For it entails (68), which entails the existence of the function in its turn.) *different* (on the interpretation intended here) is to be construed as a predication of this function, to the effect that it returns different values for different arguments. However, in order that *different* can be applied to this function, the function has to be made available first. Thus, according to the present proposal the interpretation of (65) involves three distinct steps: (i) a “first run” interpretation in which *different* is ignored; (ii) the extraction of the function from this “first run” interpretation; and (iii) the application of *different* to this function. (It should be stressed that on

this analysis relational adjectives like *different* act as predicates of functions *qua function*, i.e. as entities which embody information about what values the function returns for each of the arguments in its domain).

Even if this proposal should prove to be on the right track, it is evident that from the description we have given of it here many of the details are missing. The most serious shortcoming is that nothing has been said about the role that is played by the syntactic position which *different* occupies in (65), in virtue of which it can be interpreted as a predicate of the function which assigns topics to students. And how precisely does the relational character of the meaning of *different* contribute to the resulting reading?

The discussion of these last two examples has been speculative and the analyses we have suggested have many loose ends. We have included it nonetheless in order to make plain that the classical notion of generalised quantifiers as relations between sets is not the last word about quantification in natural language. The insight that natural language quantifiers very often work this way has been extremely important and fruitful, but it must not blind us to the fact that there is more. The same applies to duplex conditions. Duplex conditions constitute a non-trivial generalisation of the standard notion of generalised quantifiers as two-place relations between sets, but we have seen that they too cannot be applied in a straightforward manner to the analysis of the sentences in (62) and (65). These are but two examples of a range of cases of which we do not claim to fathom the diversity and complexity, but in all of which duplex conditions either are the wrong representational form or are related to syntactic structure via interpretation mechanisms that differ from those that are properly understood.

Metamathematical Properties of (Duplex Conditions for) Non-Standard Quantifiers

One often discussed type of question within the metamathematics of first order predicate logic and its various extensions is: what happens when we add one or more new quantifiers to a given formal language, and in particular what happens when we add these quantifiers to the classical first order predicate calculus itself? For instance: What can we say about the computational complexity of the notion of logical validity for the extensions of first order logic which result from such additions? Is validity still axiomatisable? If not, what is its complexity class (e.g. is it hyperarithmetical)? And what can be said about the extensions that are obtained in this way for certain natural subsystems of first order logic, such as monadic predicate logic?

axiomatisable

Among the quantifiers with respect to which some of these questions have been explored we find in particular the quantifiers *most*, *there are infinitely many* and *there are non-denumerably many*. None of these are definable within standard first order logic. They form an interesting triad insofar as between them they exemplify the different answers that are possible for the question: what happens to axiomatisability when we add this undefinable quantifier to standard first order predicate

logic? Briefly the answers are as follows. For the quantifier *infinitely many*: the extension is non-axiomatisable; for *non-denumerably many*: the extension is axiomatisable; for *most*: it depends. The first answer is an immediate consequence of Trakhtenbrot's Theorem (Non-axiomatisability of the Theory of Finite Models); the second is a famous early result in this area due to Keisler (1971); the third needs explanation.

For *most* the situation is as follows. If we assume that the generalised quantifier MOST denoted by *most* satisfies the general condition: $\text{MOST}(A,B)$ is true whenever $|A \cap B| > |A \setminus B|$ (i.e. irrespective of whether the sets A and B are finite or infinite), then the addition of MOST leads to non-axiomatisability. It is by no means evident, however, that this is the semantics for *most* that we should adopt. The condition $|A \cap B| > |A \setminus B|$ is plausible when A is finite, but far less so for cases where A is infinite. And alternative stipulations of the truth conditions of MOST, which arguably fit speakers' intuitions about what *most* means in the context of infinite sets better, can be shown to preserve axiomatisability.

We mention these few logical results about non-standard quantifiers because they illustrate what we consider an important point. Its importance will come more clearly into focus at the end of the next section. To prepare the ground for what we will say there we note the following. It appears that quantifying NPs, which have been the main topic of the present section always involve quantification over individuals, and not over sets. And the same appears to be true of adverbial quantifiers even if they sometimes involve quantification over several variables, rather than just one. This doesn't guarantee that adding such a quantifier to the first order predicate calculus will preserve its agreeable metamathematical properties, but it doesn't mean either that these properties will automatically be lost: for instance, Keisler's result [Reference XXXX] shows that axiomatisability may be preserved even though the added quantifier is not definable, adding it therefore results in a genuine extension of standard first order logic. Whether a property such as axiomatisability will be preserved thus depends on individual features of the added quantifier.

Similar considerations apply to the addition of duplex conditions to the DRS-formalism of Section 3.1. From the addition as such nothing can be inferred about the metamathematical properties of the extension. Conclusions can be drawn only on the basis of the truth conditions associated with the particular quantifier symbols Q which occur in the central components of the added duplex conditions. We recall in this connection that all duplex conditions are "formally first order" in that the discourse referents involved (i.e. those subject to either primary or secondary binding) invariably stand for individuals, and not for sets. This restriction – that all discourse referents occurring in DRSS stand for individuals – will be abandoned in the next section.

3.4 Plural

Some of the quantifying NPs we discussed in the last section – such as *most tractors* or *all farmers* – were syntactically plural. But their semantic representation, it was stressed, always involved individual discourse referents – discourse referents whose values are individual farmers etc. Discourse referents standing for sets (of two or more elements) were not needed. When we consider definite and indefinite plural NPs this is no longer true.

The point is perhaps most easily made in connection with definite plurals such as *the farmers* or *the farmers of Weybridge*. The referents of such NPs must be represented as sets when predication – say by the verb of the sentence containing the NP – is collective. Thus

(69) The farmers of Weybridge voted against the by-pass.

has a prominent interpretation according to which the vote involved all the farmers of Weybridge and they voted against it as a body – some may have voted in favour but the majority was against and so the proposal didn't carry.

Such a predication can only be plausibly represented as a predication of the set consisting of the farmers of Weybridge. To this end we now introduce discourse referents representing sets (of cardinality ≥ 2) besides the ones we have been using so far, which always represent individuals. We use capitals for the new discourse referents, as opposed to the lower case letters which we continue to use for individual discourse referents. Thus the predication in (69) will take some such form as “X voted against”, where X represents the set denoted by *the farmers of Weybridge*.

discourse referent ! set denoting

We do not want to pursue the analysis of definite NPs further at this point. We assume that all definites are presupposition triggers – they trigger presuppositions of proper reference. Accordingly their place is in Section 4, which is entirely devoted to presuppositional phenomena.

Indefinite NPs, however, are not presuppositional and plural indefinites resemble plural definites in that they can be the subjects of collective predication. Examples are the sentences in (70).

- (70) a. Five/Some lawyers hired a new secretary.
 b. Some graduates from Harvard Law School decided to set up a “legal clinic” for the poor of South Boston.

(70.a) can be understood as a joint hiring – the secretary will be working for the five lawyers – and (70.b) as saying that some group of Harvard graduates made a joint decision. Here too it is only by representing the indefinite NP via a “set” discourse referent that we can guarantee adequate representations of the collective predications. In particular, using the discourse referent X to represent the subject NP of (70.a) (and extending the construction algorithm in intuitively obvious ways on which we do not dwell here) we get for (70.a) the following DRS.

(71)

X y
lawyer*(X)
X = 5
secretary(y)
hired(X,y)

N.B. The asterisk “*” turns the predicate of individuals that is expressed by a noun N into a predication N* of sets which is true of a set X if each member of X satisfies N. Thus lawyer*(X) is equivalent to the DRS condition

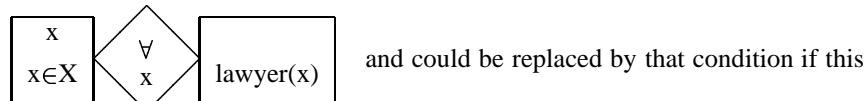

was preferred.

It might be thought that when predications involving plural definites and indefinites are not collective, the contribution made by the NP to the semantic representation could in principle be accounted for through the exclusive use of individual discourse referents. However, this is often awkward – think of how to express the contribution of *five* to the sentence *Five lawyers voted for the proposal*. – and it lacks principled motivation. It seems clearly preferable to assume that plural definites and indefinites always introduce plural discourse referents, and to treat non-collective predications involving such NPs as the result of some operation of distribution over the represented set. (For details see [Kamp and Reyle1993].)

There exists a substantial literature on the semantics of plurals (for instance [Laserson1995] and [Winter2002]). Here we concentrate on the dynamic and trans-sentential aspects of the semantic contributions made by plural NPs, focussing in particular on plural indefinites and plural pronouns.

Plural anaphoric pronouns allow for interpretational strategies that are not found with singular pronouns. These strategies involve certain inferential principles that are needed to obtain the pronoun’s antecedent. The initial goal of DRT’s account of plurality was to identify these principles, and that will also be the main purpose of the present section.

Two of these inferential principles are illustrated in (72).

- (72) a. Tom met Sue. They talked for quite a while.
 b. Few boys of Lena’s class showed up. They were smart.

Consider first (72.a). The construction of its DRS proceeds in the familiar left-to-right manner, with the representation of the first sentence providing the context for the second. If the construction is to run according to plan the DRS for the first sentence should present a discourse referent that can serve as antecedent for the anaphoric pronoun *they*. But if the DRS construction for the first sentence follows the rules we have been assuming (for details see Section 2.3 or [Kamp and Reyle1993]), then the antecedent discourse referent which represents

the set consisting of Tom and Sue is not available: no such discourse referent is a member of the DRS universe resulting from this construction; all that it contains are a discourse referent representing Tom and one representing Sue as shown by the DRS in the upper left corner of (73). In order to obtain the antecedent we want, we have to *synthesise* it out of what this DRS for the first sentence provides. The synthesis operation which accomplishes this is called *Summation*. It takes a set Z of two or more discourse referents as input and returns a discourse referent representing the set consisting of all individuals represented by the different discourse referents belonging to Z . We represent applications of the Summation operation by adding the “output” discourse referent, say X , to the DRS universe where it is wanted while adding the condition “ $X = \Sigma Z$ ” to the corresponding condition set. We use a capital letter for the new discourse referent since it invariably represents a set of two or more elements. In the case before us Z consists of the discourse referents t for Tom and s for Sue. In cases like this we write the condition “ $X = t \oplus s$ ” instead of the official notation “ $X = \Sigma\{t,s\}$ ”. We assume in addition that Summation is applied as part of the effort to resolve the anaphoric presupposition that is triggered by the anaphoric pronoun *they*. Thus it is the combination of the completed DRS for the first sentence of (72.a) and the preliminary representation of the second sentence, in which the presupposition triggered by *they* is explicitly represented, that gives rise to the application in this instance. The result of applying the Summation operation is shown to the right of the first \rightsquigarrow ; the DRS after the second \rightsquigarrow results from the resolution of the anaphoric discourse referent Y to the Summation output X ; this is the final DRS for (72.a).

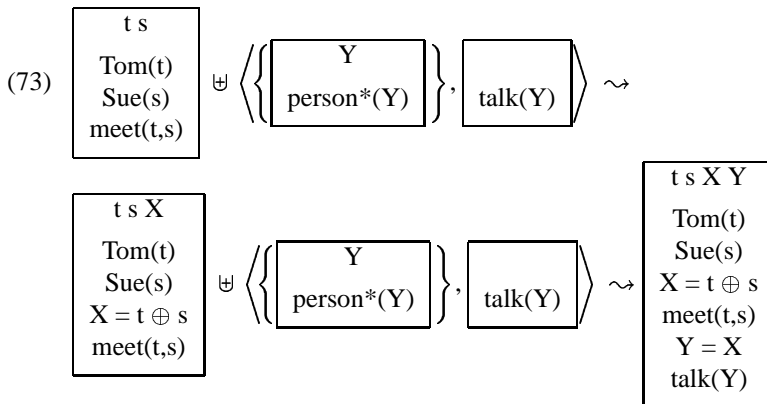

The operation that is involved in providing the antecedent for *they* in (72.b) is called Abstraction. The Abstraction operation acts on duplex conditions and introduces a plural discourse referent X that stands for the set consisting of all individuals that satisfy the DRS K which results from merging the restrictor of the duplex condition with its nuclear scope. The DRS condition expressing this has the form $X = \Sigma x.K$, where Σ is now to be understood as binding the discourse referent x . For the case at hand the condition is shown at the bottom of the DRS on the left in

(74).

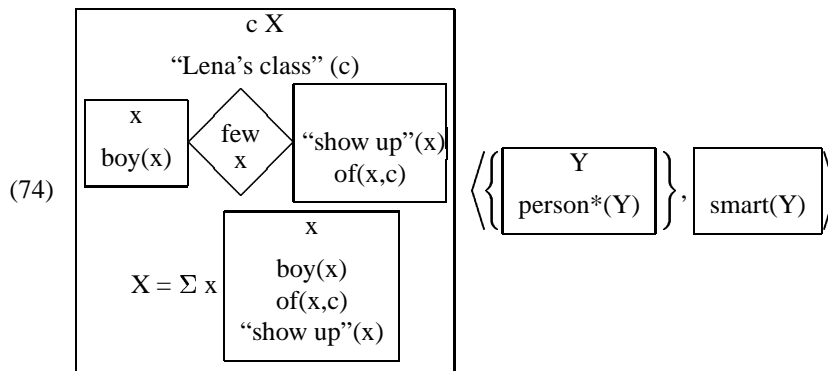

In addition to the interpretation represented in (74), (72.b) also has an interpretation in which *they* refers not just to the boys in Lena's class who showed up, but to the set of all boys in Lena's class. (In the present example this interpretation is awkward for rhetorical reasons, but it isn't hard to come up with alternatives in which it is quite natural. For instance, we could replace the second sentence of (72.b) by *Nevertheless they had all received an invitation.*) A discourse referent representing this set can also be obtained through Abstraction. But in this case the operation has to be applied to the restrictor of the duplex condition on its own.

The examples in (72) have shown that certain inference-like operations – Summation and the two versions of Abstraction – may be used to synthesise the antecedents of plural pronouns from material present in the context DRS. Since antecedents may be derived from the context through the application of these operations, it might be thought that any logical derivation from the context DRS of the existence of a set may be used to interpret a plural pronoun. Since such inferences are generally not allowed for singular pronouns (see the discussion of (42)), the difference between plural and singular pronouns would thus simply come to this: the antecedent of a singular anaphoric pronoun must have been introduced explicitly by the DRS-construction algorithm (i.e. as the discourse referent representing some earlier NP); the antecedents of plural anaphoric pronouns may be logically inferred from the context in the form which the construction algorithm imposes on it.

This way of formulating the difference between singular and plural pronouns, however, is not only misleading, it is inadequate. To see this compare the following three sentence pairs:

- (75) a. Two of the ten balls are not in the bag. They are under the sofa.
 b. Eight of the ten balls are in the bag. They are under the sofa.
 c. Few boys of Lena's class showed up. They were smart.

The *they* of (75.a) can be understood as referring to the two balls that are missing from the bag. In contrast, no such interpretation is possible for the *they* of (75.b).

Nevertheless we can infer from the first sentence of (75.b) that there must be such a set – it is the difference between sets that are explicitly mentioned, viz. the set of eight balls that are in the bag and the larger set of ten balls of which this first set is said to be a subset. But, apparently, subtracting one set from another is not a permissible operation for the formation of pronominal antecedents. And so the inference to the existence of this set, while valid, is not sufficient to have it as antecedent for the pronoun. Similarly, a plural pronoun cannot pick up the complement of a group introduced by Abstraction. The *they* in (72.c) cannot refer to the group of boys that didn't show up.

antecedent ! formation

Between them the sentence pairs in (72) and (75) show that the interpretation of anaphoric plural pronouns is supported by a restricted repertoire of logical operations which create pronoun antecedents from material in the context representation. These examples only give us a hint of what a precise characterisation of this repertoire could be like. We do not know that a formal definition of it has been attempted. But even without such a characterisation there are two conclusions that can be drawn, the first firm, the second more tentative.

The first is that what we are seeing here is a form of an aspect of linguistic knowledge: What operations may be used to construct antecedents for plural pronouns is an aspect of the interpretation of this particular type of expression. (Note in this connection that the restrictions we have observed in connection with (75.a,b) disappear when we replace the pronouns by definite descriptions such as *the missing/other balls* or *the boys who didn't come*.) Moreover, we are dealing with linguistic knowledge which pertains to the semantics of discourse, since it is often the discourse context, provided by the sentences which precede the one in which the given pronoun occurs, to which the antecedent-creating operations must be applied. (Especially for those who think of linguistic knowledge as confined to (syntactic) structure of the individual sentence, this is a phenomenon that ought to be food for thought.)

Secondly, what we have noted about the limited repertoire of logical operations available for the construction of pronoun antecedents suggests that the apparent difference between plural and singular pronouns to which we have drawn attention may well be reducible to the fact that singular pronouns stand for individuals while plural pronouns stand for sets of two or more individuals. We have noted that the operation of Summation always yields sets of cardinality ≥ 2 . Moreover, this tends to be true of Abstraction as well, viz. in all those cases where the DRS K to which the operation is applied is satisfied by more than one value for the discourse referent bound by the abstraction operator. As a rule this last condition is fulfilled. (Often it is a presupposition associated with the linguistic construction which gave rise to the duplex condition from which K is obtained, e.g. nominal quantifiers such as *every boy*, *all/most boys*.) Thus application of either Summation or Abstraction will in the normal course of events produce discourse referents that are unsuitable antecedents for singular pronouns, even if we assume that nothing else speaks against their employment in the interpretation of such pronouns. Moreover, there are some cases where Abstraction does seem to be needed to in-

interpret a singular pronoun, viz. where the sentence preceding the one containing the pronoun involves the quantifying phrase *there is exactly one ball* – as in (76).

(76) There is exactly one ball missing from the bag. It is under the sofa.

However, even if there is no difference here between the logical repertoire supporting the interpretation of plural pronouns from that of singular pronouns, it remains true that this repertoire is characteristic of the behaviour of pronouns, as one particular category of anaphoric expressions that we find in natural languages such as English.

Mereological vs. Set-Theoretical Ontology

In the DRSs displayed above graphically distinct discourse referents (lower case and upper case letters) have been used to represent single individuals and collections of two or more individuals. This could suggest that the graphically distinct discourse referents are meant to stand for entities of distinct ontological types, individuals and sets of individuals. However, in the model-theoretic semantics for the extended DRS formalism to which these DRSs belong no type distinction is made between the possible values of the two kinds of discourse referents. The ontology adopted in the models of this semantics is the mereological one first proposed for semantic purposes in [Link1983]. Link’s proposal involves a single ontological category which provides for the denotations of mass terms (NPs whose nominal head is a mass noun) as well as singular and plural count terms (NPs with a count noun as head). In this survey we are concerned only with singular and plural count terms, so only that part of Link’s ontology is relevant which concerns the denotations of those terms. This ontological category is structured by a part-whole relation \leq , and this part takes the form of an upper semi-lattice $\mathcal{A} = \langle A, \leq \rangle$ which does not have a zero element (i.e. an element $0_{\mathcal{A}}$ such that for all $a \in A$, $0_{\mathcal{A}} \leq a$) and which is complete, atomic and free.

DEFINITION 0.31.

- (i) An *upper semilattice* $\langle A, \leq \rangle$ is called *complete* if for all $X \subseteq A$ the supremum $\bigvee X$ exists.
- (ii) If a is the “largest” element of A – i.e. for all $x \in A$, $x \leq a$ – then a is called the *one of* A and denoted as $1_{\mathcal{A}}$. Similarly, if a is the “smallest” element of A – i.e. for all $x \in A$, $a \leq x$ – then a is called the *zero of* A and denoted as $0_{\mathcal{A}}$.
- (iii) By an *atom of* \mathcal{A} we understand any element $a \neq 0_{\mathcal{A}}$, such that $\forall x(x \leq a \rightarrow (x = a \vee x = 0_{\mathcal{A}}))$.
- (iv) \mathcal{A} is said to be *atomic* if for every $a, b \in A$ such that $a \not\leq b$ there is an atom c such that $c \leq a$ and $c \not\leq b$.

(v) \mathcal{A} is free if for all $a \in A$, $X \subseteq A$ if $\text{At}(a)$ and $a \leq \bigwedge X$ then $(\exists b \in X)(a \leq b)$.

With respect to a model whose universe is such a lattice $\langle A, \leq \rangle$ lower case discourse referents represent atomic elements of A and upper case discourse referents non-atomic elements. (Thus an assignment will have to map the lower case discourse referents onto atomic elements and the upper case discourse referents to non-atomic ones.) Moreover, the sum operation Σ and Abstraction operation Σx occurring within the new DRS conditions are interpreted as the join operation \vee of the semi-lattice, while the *-operator gives the closure of predicates under \vee . I.e. if P is any 1-place predicate of our representation language whose extension is a subset V of A , then the extension of P^* is the set of all $a \in A$ which are joins of subsets of V .

Upper semi-lattices which are complete, atomic and free have a remarkably simple structure. It is easy to show (see, e.g., [Kamp and Reyle1993]) that such a structure \mathcal{A} is isomorphic to a structure $\langle \mathcal{P}(B), \subseteq \rangle$ where $\mathcal{P}(B)$ is the set of all subsets of some given set B and ' \subseteq ' is the relation of set-theoretical inclusion. In particular, one can take B to be the set $\text{At}(\mathcal{A})$ consisting of all atoms of \mathcal{A} .

THEOREM 0.32. *Let $\mathcal{A} = \langle A, \leq \rangle$ be a complete, atomic, free upper semilattice without zero, and let $\text{At}(\mathcal{A})$ be the set of atoms of \mathcal{A} . Then \mathcal{A} is isomorphic to the structure $\langle \mathcal{P}(\text{At}(\mathcal{A})) \setminus \emptyset, \subseteq \rangle$.*

complete
atom
free
semilattice ! upper
isomorphic

Theorem (0.32) shows that the choice between a lattice-theoretic and a set-theoretic approach towards the model theory of singular and plural count nouns is not important from a strictly formal point of view: models based on the one approach can be readily converted into equivalent models based on the other. Even so, there are considerations of naturalness which clearly favour the lattice-theoretic approach. First, the behaviour of singular and that of plural NPs are quite similar, both from a syntactic and from a semantic perspective. In view of this, making singular and plural NPs denote entities of logical types as different as individuals (i.e. first order entities) and sets of individuals (second order entities) seems to lack motivation.

model ! lattice theoretic

A second, and more decisive, argument in favour of having a single entity type that includes the possible denotations of both singular and plural NPs is the following. Sometimes discourse referents must be allowed to take both "individuals" and "sets of individuals" as values. This can happen when a discourse referent is quantificationally bound. An example is provided by the sentences in (77).

- (77) a. All boys bought the books they wanted.
b. All boys bought books they wanted.

(77.a) can be used to describe a situation in which some of the boys wanted a single book, and bought it, while the others wanted several books, and bought them. This means that in a DRS for (77.a) the discourse referent ζ introduced by the NP *the books they wanted* must be allowed to get as value a single book when

the discourse referent x introduced by *all boys* and bound by the quantification denoted by *all* takes the first kind of boy, and a set of individuals when x gets mapped to a boy of the second kind. If we assume that ζ has a single logical type (an assumption usually made for variables of typed calculi), then its possible values must all belong to a single ontological category. The same applies to (77.b) in which the definite *the books* has been replaced by the indefinite *books*. We will return to this latter sentence below in a slightly different context, and will then also consider its semantic representation.

We conclude the present section with a brief statement of how the changes introduced in this section affect the model theory of the new extended DRS formalism. First, the model with respect to which DRSs of the extended formalism are to be evaluated are like those introduced in Section 3.1 except that the universe of a given model \mathcal{M} now has the structure $\langle A, \leq \rangle$ of a complete, atomic, free join-semi-lattice. This extra structure is directly relevant only for the evaluation of atomic DRS-conditions. The satisfaction clauses for these conditions are given in the next definition. It is to be noted in this connection that the distinction between lower case and upper case discourse referents is treated as “syntactic sugar”. In the official notation for the present DRS formalism there is still only one type of discourse referent, and discourse referents of this one sort can stand for any entity of the new ontology – i.e. for groups as well as for (atomic) individuals. We continue to use the old discourse referent symbols (i.e. $x, y, z, \dots, x_1, x_2, x_3, \dots$) and distinguish between discourse referents which stand only for individuals, those which stand only for groups and those which allow for values of either kind by means of the predicate “at”: a discourse referent x standing only for individuals comes with the condition “at(x)”, a discourse referent x standing only for groups with the complex condition “ \neg at(x)”, and when neither of these conditions is present this means that x can take values of either kind. (Distinguishing between lower case, upper case and lower case Greek letters is nevertheless a useful practice. We have also found it convenient to refer to the first as “singular discourse referents”, to the second as “plural discourse referents” and to the third as “neutral discourse referents”.) In addition, we assume that the new formalism has the cardinality functor $|\cdot|$ ($|\mathbf{x}|$ is the “cardinality” of \mathbf{x} , i.e. the cardinality of the set of atoms contained in \mathbf{x}), and moreover, a canonical name n for each natural number n (e.g., the symbol “5” might be the canonical name for the natural number five.). Finally we need to be more explicit than we have so far been about the exact form of the condition introduced by applications of Summation and Abstraction. Conditions introduced by Summation have the form $X = \Sigma \{y_1, \dots, y_n\}$. These introduced by Abstraction take the form $X = \Sigma y.K$, where, we assume, y belongs to U_K .

Definition 0.33 extends Definition 0.10 of Section 3.1 with the new clauses that now become relevant. We now assume that the universe U of the model \mathcal{M} has the structure of an atomic, free and complete upper semi-lattice $\langle U, \leq \rangle$. (They clauses are listed starting with (ix) to make clear that we are dealing with an extension of Definition 0.10.)

discourse referent ! singular

discourse referent ! plural

discourse referent ! neutral

DEFINITION 0.33.

- (ix) $g \models_{\mathcal{M}} \text{At}(x)$ iff $g(x)$ is an atomic element of $U_{\mathcal{M}}$
- (x) $g \models_{\mathcal{M}} x \in y$ iff $g(x)$ is an atomic element of $U_{\mathcal{M}}$, $g(y)$ is a non-atomic element of $U_{\mathcal{M}}$ and $x \leq y$
- (xi) $g \models_{\mathcal{M}} x = \Sigma\{y_1, \dots, y_n\}$ iff $g(x) = \bigvee \{b \in U_{\mathcal{M}} \mid (\exists y_i)(b \leq g(y_i))\}$
- (xii) $g \models_{\mathcal{M}} x = \Sigma y.K$ iff $g(x) = \bigvee \{b \in U_{\mathcal{M}} \mid (\exists h)(g \subseteq_{U_{\mathcal{K}}} h \wedge h(y) = b \wedge h \models_{\mathcal{M}} \gamma \text{ for all conditions } \gamma \in \text{Con}_{\mathcal{K}})\}$.

N.B. Both the model-theoretic extensions of the last subsection and the one stated in Definition 0.33 are easily adapted to the intensional set-up discussed in Section 3.2. We will return to the intensional perspective in the next Section, 3.5.

The Semantic Import of Plural Morphology

Most plural NPs we have considered in this section denote groups (of ≥ 2 members); they can be, and often must be, represented by plural discourse referents. In this respect they differ from quantificational NPs which, we argued in the last section, must be represented by singular discourse referents irrespective of whether they have singular or plural morphology. However, it is not only quantificational plural NPs where representation by means of a plural discourse referent is inappropriate. We saw that the direct object NPs *the books* and *books* of (77.a) and (77.b) require discourse referents that are neutral between individuals and groups. And in fact, (77) also gives us a further example of the need of singular discourse referents to represent plural NPs, viz. the plural pronoun *they*. The two occurrences of *they* in (77.a,b) can (and naturally would) be interpreted as anaphoric to the quantificationally bound singular discourse referent x introduced by the subject NP *all boys*. If the pronoun is interpreted in this way then the discourse referent that represents it must, through its identification with the singular discourse referent x , become a singular discourse referent – i.e. one whose values are restricted to (atomic) individuals – also; the discourse referent for the anaphoric expression inherits, so to speak, the features of its antecedent.

Note well that this anaphoric option for the plural pronoun *they* exists in (77.a,b) only because its intended grammatical antecedent, the subject NP *all boys*, is morphologically plural. When we change *all boys* into *every boy*, then (at least according to most English speakers we have consulted) *they* can no longer be interpreted as coreferential with the discourse referent bound by the quantifier (though it can be understood as referring to the set of boys as a whole; cf. the discussion of Abstraction earlier in this section). It thus appears that in each of the four instances of the phenomenon under discussion which we find in (77) – *the books*, *books* and the two occurrences of *they* – there is some sort of dependency of the NP in question on another NP which is morphologically plural but whose semantic representation does not involve a plural discourse referent. This seems to be a general

requirement. In the absence of such a dependency the discourse referent for a non-quantificational plural NP must stand for a group.

Let us assume that these dependency relations can be computed and then used to licence the interpretations that concern us here. This would make it possible to obtain for sentence (77.b) the representation given below in (79) via an initial representation like that in (78). In (78) the pronoun *they* is represented as part of an anaphoric presupposition; moreover, the discourse referent ζ for the NP *books* is given in a preliminary form, which creates the opportunity for its subject-dependent interpretation without yet establishing this interpretation.

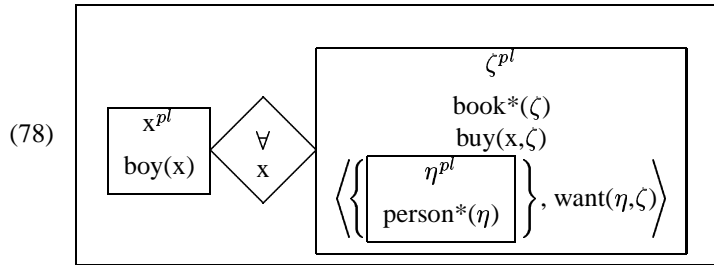

New in (78) are the superscripts pl on the discourse referents x , ζ and η . A superscript pl indicates that the NP which is represented by a discourse referent bearing it is morphologically plural. Note further that in (78) the first of these superscripts applies to the singular discourse referent x , while in the other two cases it applies to the neutral discourse referents ζ and η . The explanation is this: the unequivocally quantificational character of the NP *all boys* determines that the discourse referent x which represents it must be a singular discourse referent, whereas the status of the discourse referents represented by the plural indefinite *books* and the plural pronoun *they* is initially undetermined.

Getting from (78) to (79) requires the application of two principles.

- (i) The first principle concerns pl -marked discourse referents of anaphoric presuppositions triggered by pronouns. It says that an anaphoric pl -marked discourse referent may take a singular or neutral discourse referent as antecedent provided this antecedent discourse referent is also pl -marked.
- (ii) The second principle concerns pl -marked discourse referents which are not to be anaphorically resolved. If such a discourse referent is neutral as it stands, and it stands in the right dependency relation to another discourse referent which is also pl -marked, then it may remain neutral in the final representation.

Applying the first principle in (78) to η^{pl} and the accessible discourse referent x^{pl} leads to identification of η with x . η is thereby coerced to act as singular discourse referent. There is no coercion of ζ so ζ retains its status of neutral discourse referent. Since the superscripts pl are no longer needed, they have been omitted

in the final representation of (79). (In order to make the effects of the applications of the principles more clearly visible, we have used in the presentation of this representation the official notation introduced in the preceding subsection.)

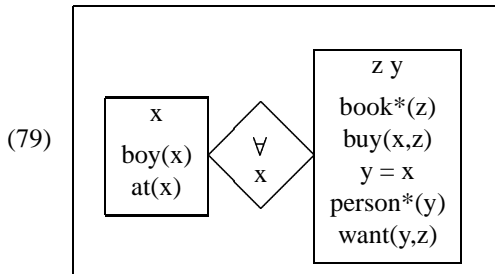

What is missing from the way in which we have dealt with (77.b) is a proper account of the dependency relations that licence the two principles just mentioned. In fact, the constraints which govern dependent interpretations of plural definite and indefinite descriptions are not the same as those which govern dependent interpretations of pronouns. This is shown by the sentences in (80).

- (80) a. Most boys have friends who have pets.
 b. Most boys have a friend who has pets.
 c. Most boys have friends they like.
 d. Most boys have a friend they like.

In (80.a) we can understand *friends* as dependent on *most boys*, so that the sentence is neutral on the question whether the boys in question have one or more friends with pets, and *pets* can be interpreted as dependent on *friends*, so that each of the relevant friends could have had one pet or more than one. But for (80.b), where the “intermediate” NP *a friend* is in the singular, the only possible interpretation is that for each of a majority of boys there is a friend who has several pets. Here the plural morphology of *pets* and *most boys* does not licence a dependent interpretation of *pets*. Apparently, the relevant dependency relation which constrains dependent interpretations of indefinite descriptions as clause bound – the licencing plural NP must belong to the same clause as the licensee. For anaphoric pronouns the situation is different. In both (80.c) and (80.d) *they* can be interpreted as coreferring with the bound variable of the quantification. That in (80.d) there is a singular NP which “intervenes” does not seem to matter.

As regards plural pronouns, we conjecture that the constraint on applications of principle (ii) comes simply to this: in order that any discourse referent can serve as antecedent for any anaphoric pronoun it must be accessible from the position of the pronoun (in the DRT-sense of accessibility). If moreover the discourse referent for the pronoun is *pl*-marked, then its antecedent must be either (a) a plural discourse referent, or (b) it must also be *pl*-marked. Thus the dependency constraint is

in this case nothing more than the already familiar relation of accessibility. The dependency constraints involved in applications of principle (ii), on the other hand, do not seem to be reducible to notions we have already introduced. Apparently these constraints are at least in part syntactic. But in any case more needs to be said about them than we are able to do here and now.

The subject of this subsection has been one which belongs squarely within the realm of the syntax-semantic interface: how and why do certain sentence constituents, with their given morphological features and in their given syntactic positions, contribute to the semantic representation of the sentence in the ways they do? This might be thought a topic that is inappropriate in a survey article like the present one, where the focus ought to be on matters of logical and/or philosophical relevance. If we have decided to include the above discussion nevertheless, that has been for two reasons. First, syntax-semantics interface questions are of interest from a general philosophical perspective insofar as they reveal how complex the relationship between syntactic structure and logically transparent semantic representation can be: the principles according to which information is encoded in natural language differ significantly from those which determine the organisation of logical representation languages such as predicate logic or the DRS-languages of DRT. Exactly what these differences are and why they exist is surely of central interest for the philosophy of language, for the foundations of logic and for our general understanding of human information processing.

But there is also a second reason why we consider the problems that have been discussed in this subsection to be one of general interest. It is related to the first reason, but more specific. The general problem of the relation between meaning and linguistic form is often equated with the “syntax-semantics interface”. Part of this equation is that syntax defines linguistic form and therewith both the input to and the constraints on the mapping which produces meanings as outputs. This is pretty much the standard view, and in first approximation it is surely correct. However, the problems we have discussed throw doubt on the simplicity of this view.

Apart from the dynamic aspects of this mapping, in view of which it is more appropriately seen and treated as a mapping from discourses and texts to meanings rather than from single sentences – this is the general message of dynamic semantics, and in no way specific to what has been said above – the discussions of this subsection have pointed towards the need for a “cascaded” mapping procedure, in which the syntactic structure of a sentence is first transformed into an “initial” semantic representation, and then from this initial representation into the representation which renders its semantic contribution in definitive, fully transparent form. However, it is clear neither of the initial representation itself nor of the operations that must be applied to it to turn it into the final representation whether they belong on the syntactic or the semantic side of the dichotomy that is implicit in a simple-minded conception of the relation between form and meaning. Particularly problematic in this context is the allocation of the operations Summation and Abstraction. On the one hand these seem to belong on the side of meaning in that

they operate on structures in which much of the information of the sentence has been made transparent already. On the other, they appear to be sensitive to aspects of linguistic form that are reflected in the “semantic” representations which serve as their application domains.

As we have seen intermittently in earlier sections, and will see in greater detail in Sections 4 and ?? below, the need for a cascaded architecture of DRS construction (and thus of the mapping from syntactic form to transparent representation of meaning) arises also for other reasons. The most important of these has to do with the treatment of presupposition which will be presented at length in Section 4. The basic assumption underlying this treatment is that presuppositions must first be given explicit representations which are then subjected to a (linguistically motivated) process of presupposition justification, after which they either disappear from the semantic representation or else are integrated into its non-presuppositional core.

Metamathematical Properties

We conclude this subsection with an observation which links up with the concluding remarks of the last one. There we noted that the addition of non-standard quantifiers to the first-order DRS-formalism of Section 3.1 may but need not lead to the loss of axiomatizability. We also noted that the class of quantifying NPs include plural as well as singular forms. But all of these, we argued, introduce singular discourse referents. In contrast, indefinite and definite plural NPs, we have seen in the present section, are often (if not invariably) “semantically plural” in that they denote non-atomic entities (or, in more traditional terms, sets of cardinality ≥ 2). It is a consequence of this addition that the DRS formalism of this section necessarily transcends the boundaries of first order logic.

It should be stressed that it is the plural *indefinite* NPs that are the principal culprits here. To see this, observe that it is possible to state the induction axiom of second order Peano Arithmetic by means of the following English sentence:

(81) If 0 is among some numbers and the successor of a number is among them if that number itself is, then they include all the natural numbers.

(Note that this sentence does not make use of a noun such as “set”. The crucial phrase, which is responsible for the irreducibly second order status of (81), is the NP *some numbers*.)

If we combine (81) with sentences which state the familiar axioms of Peano Arithmetic (those saying that the successor function is a bijection from the set of natural numbers without 0 to the set of all natural numbers, together with the recursive axioms for + and \times , then we get a version of Peano’s second order axioms, an axiom system which has the standard model of arithmetic for its only model. This entails that the truths of arithmetic are an (easily recognisable) subset of the set of logical consequences of this axiom set. So, the set of these logical consequences

has at least the complexity of that of the truths of arithmetic. Consequently it does not admit of a proof-theoretical characterisation. The same is true for a set of DRSs which give truth-conditionally correct representations of these axioms. In particular, if (82), which is a truth-conditionally correct representation of (81), is merged with DRSs for the other Peano axioms mentioned into a DRS K , the set of DRSs which are logically entailed by K is not amenable to proof-theoretic characterisation. Since all compounds of K other than (82) are first order (i.e. they can be given in a first order DRS language of the kind discussed in Section 3.1) non-axiomatisability must be due to (82), and thus to the presence in it of the plural discourse referent X , since that is the one feature of (82) which sets it apart from first order DRSs. And as far as the sentence in (81) is concerned, which (82) represents, the feature which makes it second order is the indefinite plural *some natural numbers* which is responsible for the presence of X in (82).

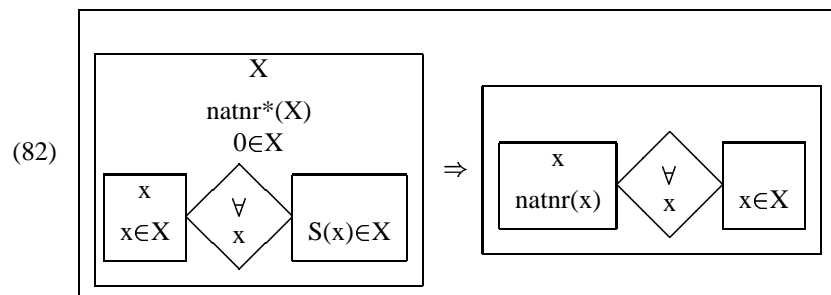

One noteworthy feature of this example is that it shows how little of the additional resources made available by the introduction of plural discourse referents is needed to move outside the realm of first order logic: (82) contains only one plural discourse referent, occurring within the scope of a single logical operator (viz \Rightarrow). If the present formalism were restricted in such a way that an axiomatisable fragment results, hardly any of the additional expressive power that plural discourse referents introduce would be preserved.

It deserves to be stressed that it is an *indefinite plural* NP which is responsible for the second order status of (81). We saw at the end of the last section that non-axiomatisability may result from the incorporation of non-standard quantifiers. But whether this happens will depend on incidental and often subtle features of the particular quantifier in question. Moreover, since these quantifiers only bind variables ranging over (atomic) individuals, there is an important sense in which they do not transcend the bounds of first order logic. In this regard the extension of the present section is much more radical. It introduces a form of quantification over sets and this leads us directly into second order logic, with all the dire metamathematical consequences that entails.

3.5 *Tense and Aspect*

The starting point for DRT was an attempt in the late seventies to come to grips with certain problems in the theory of tense and aspect. In the sixties and early seventies formal research into the ways in which natural languages express temporal information had been dominated by temporal logic in the form in which it had been developed by Prior and others from the fifties onwards. By the middle of the seventies a large number of tense logics had been formulated, many of them for the very purpose of analysing temporal reference in natural language. It became increasingly clear, however, that there were aspects to the way in which natural languages handle temporal information which neither the original Priorian logics nor later modifications can handle. And some of these problems had to do directly with the behaviour of tense, i.e. with that feature of natural languages which had been a primary source of inspiration for the development of temporal logic in the first place. (In earlier days the term “tense logic” was the common way to refer to Prior-type temporal logics, and it is still used by many today.)

A particularly recalcitrant problem for the temporal logic approach are the differences between two past tenses of French, the *imparfait* and the *passé simple*, and the largely similar differences between the past progressive and simple past in English. In many contexts it is possible to use either tense form to describe the same situation. An example is given by the pair of English sentences in (83).

- (83) a. Hans was filling out his visa application form.
 b. Hans filled out his visa application form.

On the face of it these sentences may seem to have the same truth conditions. But one feels that there is an important difference between them nevertheless. To explain what this difference consists in has been a problem of long standing. It was seen as a problem especially by those who taught French to non-native speakers and had to explain to their students when to use the *passé simple* and when the *imparfait*, and why.

Earlier attempts to account for the distinctions between these tenses (as well as between their English counterparts) were often couched in metaphorical or quasi-metaphorical terms. Thus, the differences between (83.a) and (83.b) have been variously described in terms like:

- (84) a. (83.a) presents the event of which it speaks as “open”, (83.b) presents it as “closed”;
 b. (83.a) presents its event “from the inside”, (83.b) “from the outside”;
 c. (83.b) presents its event as “punctual”, (83.a) as “temporally extended”.

Moreover, it has been pointed out that when sentences in the *passé simple* or simple past occur in a narrative, they often “carry the story forwards”, while sentences in the past progressive or *imparfait* hardly ever do this.

As they stand, these formulations are too informal and imprecise to be of much use in a systematic analysis. But they contain clear hints why it is that temporal logics aren't the right tools to explain what the difference between these tenses is. There are a number of reasons for this, three of which will be mentioned here. The first has to do with the temporal ontology on which an analysis of the tenses (and of temporal reference in natural language generally) should be based. Even a fairly cursory inspection of the way temporal reference works in natural language reveals that temporal intervals play as important a role as temporal points; in fact, from the perspective of natural language there does not seem to be a principled distinction between instants and intervals. This is at odds with Prior-type tense logics, with their commitment to the concept of "truth at an instant".

In the seventies alternative temporal logics – so-called interval logics – were developed to remedy this. But when we turn to the next two objections against temporal logics, interval logics are no real improvement on tense logics of the Priorian sort. The first of these has to do with the fact that in temporal logic – whether we are dealing with a point logic or an interval logic – time only enters at a meta-linguistic level. The formulas of temporal logics do not have any means to refer to times directly and explicitly – they have no terms whose values are points or intervals of time. This was originally seen as a virtue of tense logic. The tenses of the verb, it was thought, carry temporal information but they do this without making explicit reference to time. In this respect they are much like modal operators such as *necessarily* or *it is possible that*, which have to do with what might be or might have been the case as well as with what is, but do so without explicitly referring to possible worlds.

The principal reason why this is the wrong conception of the way in which temporal reference is handled in natural language is that tenses are not the only means that natural languages use for this purpose. As often as not the temporal information conveyed by a natural language sentence or discourse is the result of interaction between several kinds of elements, of which the tenses constitute only one. Among the others we find in particular temporal adverbs and prepositional phrases such as *three hours later*, *on the first of February 2001*, etc. and these clearly do refer to times in a direct and explicit manner. (If these aren't explicitly referring expressions, what expression would count as referring?) Consequently, one would presume the logical forms, or semantic representations, for sentences in which such adverbs occur to contain devices for explicit reference to time as well. But the formulas of temporal logics do not. So they provide the wrong repertoire of logical forms.

A first hint of this is implicit in the informal observation concerning (83.a) and (83.b) that sentences in the simple past have the capacity to "carry the story forwards" while past progressive sentences do this hardly if ever. There are two sides to this difference – on the one hand simple past sentences differ from past progressives in the contexts which they contribute to the interpretation of the sentences which follow them; on the other there is a difference in the way in which simple past and past progressive sentences make use of the context which the sentences

logic ! point

logic ! interval

time

that precede them provide. Thus the dynamic dimension of what distinguishes these two tenses is both forward-directed and backward-directed.

The difference between the backward dynamics of simple past and past progressive comes roughly to this: When a past progressive sentence such as (83.a) occurs as part of a narrative passage or text, it is typically interpreted as describing a process that was going on at the time which the story had reached at that stage, i.e. as a process going on at the last time of the context established by the antecedent discourse. In other words, the temporal relation between the process described by the new sentence and the last time from the discourse context is that of temporal inclusion, with the process described by the new sentence including the time from the discourse context. In contrast, a simple past sentence like (83.b) is more naturally understood as presenting the event it describes as the next one in the sequence of narrated events, and thus as following the time reached thus far. ([Kamp1979, Kamp1981b, Kamp and Rohrer1983a, Partee1984].

We see this distinction between simple past and past progressive when we compare (85.a) and (85.b). Each of these is a “mini-text” consisting of two sentences. The only difference between them is that the second sentence of the first text has a past progressive whereas the second sentence of the second text is in the simple past:

- (85) a. Josef turned around. The man was pulling his gun from its holster.
 b. Josef turned around. The man pulled his gun from its holster.

The difference between (85.a) and (85.b) seems clear: in (85.a) the man is in the process of pulling his gun from its holster when Josef turns around and sees him. Here the second sentence is understood as describing a process that was going on at the point when Josef turned around. (85.b) is interpreted more naturally as saying that the event of the second sentence – i.e. that of the man pulling his gun from its holster – occurred after Josef turned around, presumably as a reaction to it.

An account of these differences in terms of the anaphoric properties of the tenses involved has to make use of some notion of context-supplied “reference point”: the antecedent discourse provides a reference point (here as in many other cases: the time or event to which the story has so far advanced) with which the tense of the new sentence establishes a certain anaphoric relation. It seems natural therefore to build on what is undoubtedly the most famous early theory of tense in which the notion of reference point plays a prominent role, viz. that of [Reichenbach1947]. Unfortunately, however, Reichenbach’s theory cannot be taken over as is. The difficulty has to do with what is arguably the most salient feature of this theory, its so-called “two-dimensionality”. Reichenbach’s theory is called a two-dimensional theory of tense because it analyses the tenses in terms of pairs of relations, one between utterance time and what Reichenbach calls “reference time” and a second relation between reference time and the described “eventuality” (i.e. state or event).¹⁹

As we will argue below, Reichenbach's use of the notion of reference time suffers from the defect that it is "overloaded": in his theory reference times are made to do too many things at once. For this reason the DRT account of temporal reference has replaced Reichenbach's notion by a pair of notions which share the burdens of the original notion between them. They are: (i) the notion of "perspective time", which plays the role of Reichenbach's reference time in his analysis of the past perfect (about which more below) and which is responsible for the two-dimensionality of the account presented here, and (ii) a second notion, for which the name "reference time" has been retained. It is the second notion which is used to account for the difference between (85.a) and (85.b).

To present this account in succinct terms is not all that easy. A number of preliminaries have to be dealt with before we can proceed towards the actual representations of (85.a) and (85.b), which are given in diagrams (87)–(89) below. Should the reader feel he is getting lost or bored, s/he might find it helpful to take a glance ahead at these diagrams.

For the time being we only consider those tenses for which temporal perspective time is not needed. (Simple past and past progressive, in the interpretation which matters in connection with (85.a), are among these.) The analysis of these tenses involves two relations, a relation between the utterance time and the described eventuality and a relation between this eventuality and the reference point. For both simple past and past progressive the first relation is that of temporal precedence – the eventuality precedes the utterance time. But with regard to the second relation the two tenses apparently differ. Simplifying somewhat: in the case of the past progressive the relation is temporal inclusion, in the case of the simple past it is not. (In the case of (85.b) the relation is temporal succession – the eventuality follows the reference time. In fact, the simple past often signifies temporal succession, but it doesn't always, a point to which we return below.)

The semantics of the tenses is complicated by a factor we have not yet mentioned. This is the role that is played by aspect. The term "aspect" covers a complex spectrum of interconnected phenomena. In the DRT-based theory of temporal reference we present here aspectual phenomena are considered only insofar as they have an effect on temporal reference. The theory assumes that it is possible to account for this influence by drawing a single binary distinction, that between events and states: Tensed clauses are assumed to have either stative or non-stative aspect; in the first case the eventuality described by the clause is a state, in the second it is an event. (So the totality of eventualities consists of two disjoint parts, the events and the states.)

In general the anaphoric properties of stative and non-stative clauses may differ even when they have identical tense morphology. This causes a problem for the line of analysis we have sketched, according to which it is the tense form alone which determines the temporal anaphoric properties of the clause. As it turns

¹⁹We follow the widely adopted practice within the formal semantics of tense and aspect to use [Bach1981]'s term "eventuality" as a common term for the events, states, processes etc. which verbs can be used to describe.

perspective time

utterance time

aspect

event

state

out, however, it is possible to deal with this problem without deviating too much from what we have outlined so far. All that is required is a slight complication of the analysis of the two above-mentioned relations – that between eventuality and utterance time and that between eventuality and reference time. The complication comes to this: we do not analyse the relations as directly involving the eventuality itself, but rather its “location time”. Informally, the “location time” of an event is to be seen as the time when the event is said to occur and the location time of a state as the time at which the state is said to hold.

This leads to an analysis of tense in which the location time gets “interpolated”, as it were, between eventuality on the one hand and utterance time and reference time on the other, and which involves three relations instead of two: (i) a relation between location time and utterance time; (ii) a relation between location time and reference time; and (iii) a relation between the eventuality and its location time. The difference between the simple past of the second sentence of (85.b) and the past progressive of the second sentence of (85.a) manifests itself through the third relation: In the case of the second sentence of (85.b) (or, for that matter the first sentence of (85.a) and (85.b)), the relation is inclusion of the described event in the location time. The past progressive determines the inverse inclusion relation: the location time is included in the described state.²⁰

According to what we said so far, the semantic contribution of tense involves a combination of two things: on the one hand a relation between location time “ t_{loc} ” and utterance time “ n ” and on the other a relation between location time and reference time “ r ”. The first contribution varies according to whether the tense is classified as past, present or future. The contributions are given in (86).

(86) Contribution of tense:

<i>past</i>	<i>pres</i>	<i>fut</i>
t_{loc} $t_{loc} < n$	t_{loc} $t_{loc} = n$	t_{loc} $n < t_{loc}$

The second contribution, we said, is of an anaphoric character. Adopting the position announced in Section 2, according to which anaphora is a presuppositional phenomenon, we analyse this contribution as taking the form of a presupposition: the tense of a clause triggers a presupposition to the effect that the location time of the eventuality which the clause describes stands in a temporal relation ρ to a reference time r ; r has to be linked, via a process of anaphoric presupposition resolution, to an element from the context. In the cases which concern us here this is the context established by the antecedent discourse.

²⁰This principle generalises to the progressive and non-progressive forms of other tenses, and beyond that to stative and non-stative clauses of any kind: when the clause is stative (and in particular when its verb is in the progressive), the location time is included in the described state; when the clause is non-stative, the described event is included in the location time.

Treating the second contribution of tense as a presupposition entails that the representation of a tensed clause involves two stages, one in which the presupposition is explicitly displayed and one in which it has been resolved. (Recall the sketch of this architecture in Section 2.3; for more details see Section 4 below).

At last we come to the first of our representations. (87) gives a combination of the complete representation of the first sentence of (85.b) together with the preliminary representation of the second sentence. (For the first sentence of a discourse there is no discourse context. In such cases resolution of the tense-triggered presuppositions is governed by certain default rules; we ignore these here.) The first of the two relations contributed by the simple past of the second sentence – that between location time and utterance time – has been incorporated into the non-presuppositional part of the representation of this sentence (the structure on the right); the second relation is represented as presupposition prefixed to this non-presuppositional part (the structure in the middle). Note that the temporal relation ρ has not yet been identified with the one which we have argued gives the intuitively correct interpretation in this case, viz. that t_2 comes after r . The reason is that in general this relation depends on more factors than tense alone. More on this point below.

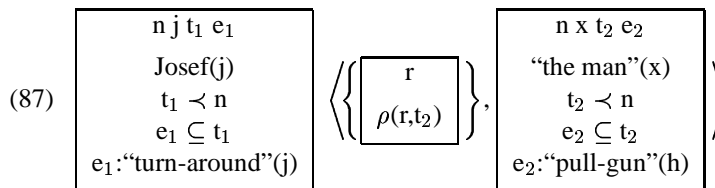

Before we say more about the presupposition of (87), a couple of remarks are in order about features of the representations shown in (87) which are fundamental to DRT’s treatment of tense and aspect in general.

1. The first remark concerns the new types of discourse referents that are found in (87). Among these there are in the first place discourse referents standing for times (t_1 , t_2 , n). The presence of these discourse referents is enough to set the representation formalism which (87) exemplifies apart from the formalisms offered by the temporal logics mentioned at the start of this section, in which there is no explicit reference to time.

In addition we find in (87) also discourse referents for eventualities (e_1 , e_2). After the informal discussion which led up to (87) this will hardly be surprising. Nevertheless it is a point which deserves special emphasis. The presence of these discourse referents is testimony to our conviction that (most) natural language sentences should be analysed as descriptions of eventualities. (More often than not the eventuality a sentence describes is introduced into the discourse by the sentence itself. But a sentence can also be used to provide an additional description of an eventuality that has been introduced previously.) Within semantics this view is

at present hardly controversial and it is deeply embedded in the ways in which semanticists think about a wide variety of issues. From an ontological point of view however, events form a notoriously problematic category, for which identity conditions and structural properties and relations are hard to pin down and have proved a never ending topic for debate. For the philosopher and the philosophical logician it is therefore tempting to try and do without them.

There is a conflict here between philosophical conscientiousness and the needs of linguistic theory. (Cf. [Bach1981] on the distinction between “real metaphysics” and “natural language metaphysics”.) We have argued elsewhere (see [Kamp and Reyle1993]) that this is a case where ontological theory just has to do the best it can, and that a form of “underspecified” model theory is the best option for realising this. A few words will be devoted to this in the last part of this section where we sketch the model theory for the DRS language to which (87) and the following DRSs of this section belong.²¹

2. The second remark concerns the occurrences of the discourse referent n . n is an *indexical discourse referent*. It represents the utterance time of the represented discourse or sentence. (“ n ” stands for “now”.) Its presence introduces a pragmatic element into our representations which played no role up to this point. DRSs which display occurrences of n have to be understood not as representations of sentence or discourse *types*, whose identity is determined exclusively by linguistic form, but as representations of particular utterances (i.e. sentence or discourse *tokens*), which are made at some particular time.²² The pragmatic element which n introduces into a DRS has implications for verification and truth. The verification of a DRS K which contains occurrences of n like those we find in (87) must take account of the time t_u at which the represented sentence or discourse is uttered. This means that only assignments f are to be considered for which $f(n) = t_u$. A

discourse referent ! indexical
pragmatics

²¹Of the arguments in favour of the view that verbs are to be treated as predicates of events, processes or states we mention here just two:

(i) This argument has to do with the relation between deverbal nouns and the verbs from which they are derived. It is generally assumed that deverbal nouns (such as *walk*, *cleaning* or *action*, etc.) are treated as predicates, and thus, inevitably, as predicates of some such entities as events. (This, to our knowledge, is an assumption that has never been seriously challenged.) If that is right, however, then it is highly artificial not to treat the verbs from which these nouns are derived as event predicates also.

(ii) Treating verbs as predicates of eventualities restores an apparently universal feature of natural language predication which is lost when verbs are denied an eventuality argument. Note that all predicate-like word classes of natural languages other than verbs – in particular nouns, adjectives/adverbs and prepositions – are analysed as predicates one argument of which is syntactically implicit: This argument is not realised by a separate phrase, but carried by the lexical predicate itself. Thus a “relational” noun such as *friend* has one “internal” argument, which can be realised by an adjoined *of*-PP, such as *of Maria* in the NP *a friend of Maria*. But the other argument, the one for the person who is Maria’s friend, cannot be realised by an explicit argument phrase. We find the same with non-relational nouns such as *girl*, *broom*, etc. Here there is only one argument and it is implicit in the same way as one of the two arguments of *friend*.

Note well that both these considerations apply as much to stative as to non-stative verbs.

²²As well as by some particular speaker, and usually addressed to some particular person or audience, but these last two factors are of no importance in this section and will be left aside.

consequence of this is that verification of K is only possible in models (and, in case we are dealing with intensional models, at worlds of those models) in which the time of the utterance represented by K exists. (For more on this check the model theory for the DRS language which is presented in the last part of this section.)

With these two general observations behind us we return to the details of example (85.b). (87), we pointed out, contains a presuppositional component – viz. the DRS in curly brackets. Resolution of this presupposition requires finding specifications of two of its constituents, r and ρ . For sentences in the simple past the relation ρ is, as we noted in our informal gloss on the sentences in (85) above, often that of temporal succession: the new event e_2 occurred after the last event reached by the discourse so far, here e_1 . To convert (87) into a representation which expresses this relation, the anaphoric discourse referent r must be resolved in the context that is provided by the DRS for the first sentence of (85.b). For all we have said so far, r could be resolved either to e_1 itself or to its location time t_1 . We adopt the second option without argument.

We will return to the problems connected with the presupposition of (87) below, at the point when we will be in a position to compare the analysis of (85.b) with that of (85.a).

After resolving r to t_1 , specifying ρ as \prec , incorporating the (now justified) presupposition into the representation of the second sentence and then merging the two DRSs into one, we get as final representation for (85.b) the structure given in (88).

$$(88) \quad \boxed{\begin{array}{l} n \ j \ t_1 \ e_1 \ x \ t_2 \ e_2 \\ \text{Josef}(j) \\ t_1 \prec n \\ e_1 \subseteq t_1 \\ e_1: \text{“turn-around”}(j) \\ t_1 \prec t_2 \\ \text{“the man”}(x) \\ t_2 \prec n \\ e_2 \subseteq t_2 \\ e_2: \text{“pull-gun”}(x) \end{array}}$$

We have seen that (85.a) differs from (85.b) in that the eventuality of the second sentence is now understood as a process that is going on at the time of the event of the first sentence, and not as an event which follows it. Given the way in which we have analysed the second sentence of (85.b) in (87) and (88) one would expect this difference between (85.a) and (85.b) to manifest itself as a difference in the relation ρ : ρ should now be inclusion. More precisely, assuming that r is once more resolved to t_1 , the relational condition of the presupposition should now be “ $t_1 \subseteq t_2$ ”.

This comes fairly close to what we want, but as it is, it isn't quite right. It isn't for two separate reasons. The first is that what we are really after is the conclusion that the eventuality e_1 described in the first sentence is included in the eventuality described in the second. Given the assumptions we have made, the condition " $t_1 \subseteq t_2$ " does not guarantee this; it would if we could also rely on the condition " $t_2 \subseteq e_2$ ". But that is not what (87) tells us: It specifies that " $e_2 \subseteq t_2$ ", not that " $t_2 \subseteq e_2$ ".

The second reason is that even if the relation between e_2 and t_2 is reversed, there is still a problem with the characterisation of e_2 by means of the condition " e_2 :*pull-gun*(x)". In the literature on tense and aspect this second problem is known as the *imperfective paradox* (see [Dowty1979]). It manifests itself in connection with a number of different linguistic constructions: with progressive forms of event verbs in English, with imparfait sentences in French, and also in a number of other situations which are of no direct concern here. When an event verb occurs in one of these constructions it is usually interpreted as describing a process that can be viewed as an initial segment of an event of the kind that the verb describes when it is used "non-progressively". However, there is no requirement that the described event segment actually evolves into a complete event of this kind.²³ The imperfective paradox is exemplified by (85.a) in that this sentence can be used to describe a scene in which the man never managed to get his gun out of its holster because Josef, with his widely known and much-feared reflexes, made sure he didn't.

imperfective paradox

The DRT account we present here deals with these two problems by not treating the past progressive as a complex tense (as was implied by the discussion up to this point), but by assuming, rather, that the past progressive factors into (i) the past tense; and (ii) an aspectual operator PROG. PROG transforms an event type E into a state type PROG(E). In particular, when the event predicate in the scope of the progressive is (as it is in our example) given by the event typing condition " e :*pull-gun*(x)" (see the right hand side representation of (87)), then the condition which characterises the state s as being of the corresponding PROG-type has the form " s : PROG($\wedge e$:*pull-gun*(x))". (Here \wedge is the intensional abstraction operator of Intensional Logic, see Section 3.2, Definition 0.30.)

progressive

operator ! aspectual

PROG

The past tense of a verb occurring with past progressive morphology is assumed to carry the same semantic import as the past tense of a sentence in the simple past (such as, e.g., the second sentence of (85.b)). Thus the contribution which the past tense makes to the semantics of the second sentence of (85.a) is the same as the one it makes to the three other sentences of (85.a,b). In all cases it is the contribution given by the past tense specification in (86). The difference between the interpretation of the second sentence of (85.a) and that of (85.b) now results from an aspectual difference between events and states. As already noted an event is assumed to occur within its location time, whereas a state is assumed to be going

²³Although there does appear to be a requirement that a completion into such an event be intended by the agent, or that the segment would have turned into one if it hadn't been for some external interference which prevented this.

on during its location time.

With these additional assumptions we get for (85.a) the representations (89.a) (corresponding to (87)) and (89.b) (corresponding to (88)).

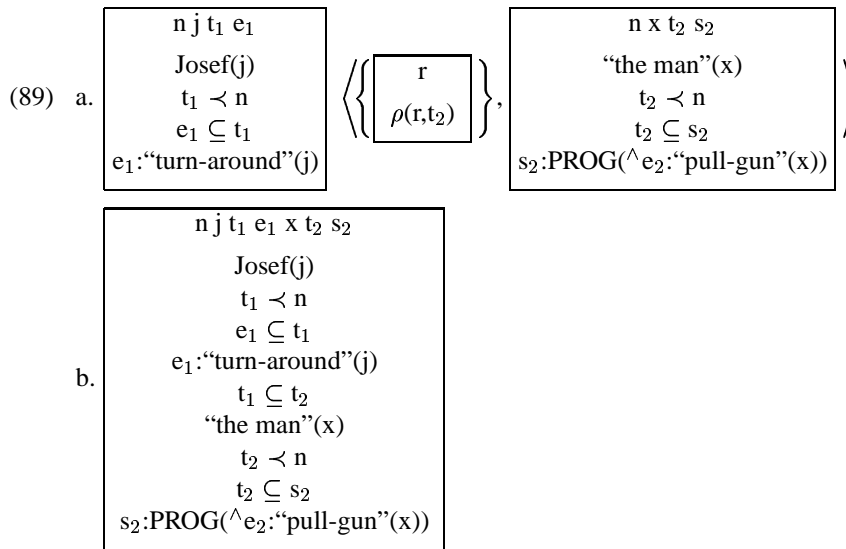

Discussion: How to choose the Reference Time, Temporal Relations and Discourse Relations?

The analysis of (85.a) and (85.b) we have shown here has been challenged by linguists who share many of our assumptions ([Partee1984, Hinrichs1986, Roßdeutscher2000]). The controversy concerns the interpretation of the two elements of the tense-triggered presupposition – see (87) – which need resolution in context, viz (i) the reference time r and (ii) the relation ρ in which r stands to the new location time. The mentioned authors argue for a different conception of narrative progression, and with that for a different way of identifying reference times. On this alternative view an event sentence in a narrative introduces not only the event it describes into the discourse context but also a “reference point” which follows this event and acts as the (default) location time for the eventuality of the next sentence. Stative sentences do not introduce such a subsequent point. They inherit their “reference point” from the context in which they are interpreted and pass it on to the next sentence. This is one reason why, on the account now under discussion, event sentences propel the story forward but stative sentences do not. On this alternative account the determination of the relation ρ becomes simpler: ρ is always identity between the reference point and the new location time.²⁴

²⁴Rosdeutscher’s account differs from those of Hinrichs and Partee in ways that are difficult to explain at this point. We return to this later.

The simple and uniform way in which the alternative account handles ρ seems to speak in its favour. But on the other hand it also encounters certain difficulties which do not arise for the approach we have presented. For instance, it cannot explain directly why (85.a) seems to imply that the pulling of the gun out of its holster was going on when the event e_1 of Josef turning around occurred. All it yields is that the process goes on at the reference point following e_1 ; that it was going on at the time of e_1 itself must be attributed to some further inference. It is clear that a motivated choice between the two accounts requires looking at many more examples than the pair that has been considered here. However, when one looks more closely at examples that might help to decide between the two accounts, one finds that the crucial judgements not only tend to be delicate and unstable, but also that they are influenced by factors that neither account takes into consideration. What is really needed, is therefore not so much a choice between these two accounts, but a theory which is capable of dealing also with these additional factors.

Many of these factors have to do with rhetorical and other discourse relations.²⁵ (90) gives a few simple examples in which the effects of rhetorical relations on temporal relations are easy to perceive. In (90.a) the event reported in the second sentence may overlap the one reported in the first, $e_1 \circ e_2$. This is typically the case if the second sentence is an *elaboration* of the first. A reversed temporal order, $e_2 \prec e_1$, is induced by the causal relation between the events reported in (90.b), where the second sentence is understood as giving a (causal) *explanation* of the first. And in (90.c) temporal progression, $e_1 \prec s_2$, (instead of overlap) is also induced by an assumption of causality. Here the second sentence issues to describe a *result* of the event reported in the first rather than a state that obtained while the event occurred.

rhetorical relations
discourse relations

elaboration

explanation

result

- (90) a. Chris had a fantastic meal. He ate salmon.
 b. Max fell. John pushed him.
 c. John turned off the light. The room was pitch dark.

Theories of discourse interpretation ([Moens and Steedman1988, Hobbs1990, Caenepeel1989, Lascarides and Asher1993, Asher1993]) use rhetorical and other discourse relations to represent the conceptual glue between the eventualities reported. The first theory to deal with discourse relations within a formal dynamic setting was Asher's S(egmented) D(iscourse) R(epresentation) T(theory). (See

²⁵One way to get a sense of the different factors that affect our judgments of temporal relations in discourse is to try to construct minimal pairs like that of (85), where the only difference is that a certain verb occurs in one member of the pair in the simple past and in the past progressive in the other. In order for it to be easy to get the contrast which (85) is meant to illustrate, the verb in question must allow on the one hand an interpretation according to which the action it describes is something which the agent could have been engaged in independently of (and thus antecedently to) the event described in the immediately preceding sentence, and on the other hand as an action which the agent could be seen as performing as a reaction to that event. When either of these requirements fails, one of the two texts becomes infelicitous or the intended contrast is no longer salient.

[Asher and Lascarides2003] as well as the SDRT publications cited there. Another important body of work in this area is that of Webber and others. See [Webber1988, Stone1998].) SDRT exploits non-monotonic logic to determine the possible interactions between discourse structure and temporal structure. Updates trigger usually defeasible inferences from an axiomatic system combining discourse relations, temporal relations and world knowledge. Cases where different sources supply conflicting conclusions about interpretation are dealt with by the underlying non-monotonic logic.

We wish to stress, however, that it is nevertheless important for a theory of temporal interpretation which accounts for the correlations between temporal relations and discourse relations to also pay due attention to all constraints that are imposed on temporal relations by linguistic form. We refer to [Rosseidscher and Reyle2000]. The strategy adopted there is in essence the same that is implicitly assumed in this entire chapter: First, an interpretation is constructed on the basis only of the linguistic information contained in the interpreted sentence or sentences. The temporal relations contained in the representation which results from this first, “purely linguistic” interpretation process will often be underspecified. However, further interpretational operations, which use the initial representation as input, may compute the discourse relations between the represented sentences. On the strength of these discourse relations the initially underspecified temporal relations may then be resolved or the underspecification reduced. Overall, this strategy does not differ essentially from SDRT in its current form ([Asher and Lascarides2003]).

Tenses and Temporal Adverbs

So far we have only considered sentences for which the interpretation of tense involved a link to a reference time supplied by the antecedent discourse. Through this link between location time and reference time the new eventuality is temporally located in relation to the context established by the preceding sentences of the discourse of which the new sentence is an integral part. It is just as common, however, for the eventuality to get temporally located sentence-internally, through the presence of a temporal adverb. A few examples of such cases of sentence-internal location are given in (91)

- | | | | |
|------|--|---|---------------------------|
| (91) | On 03 03 03
Once upon a time
On the last day before his marriage
On a Sunday
On the preceding Sunday
The next day
Last Sunday
Yesterday
Yesterday, between 4.00 and 6.00
After the exam
During the summer holidays | } | Fred bought a lawn mower. |
|------|--|---|---------------------------|

Each of these different adverbs gives information about the time when Fred bought a lawn mower.

The first point to notice about the examples in (91) is the variety of referential mechanisms involved in determining what times the adverbs denote. Temporal adverbs display the full range of referential possibilities which we find with noun phrases in general – absolute, anaphoric, indexical, etc. This of course is no surprise, given that many temporal adverbs have the form of prepositional phrases. In addition, we find temporal adverbs subject to referential mechanisms which depend crucially for the way they work on the structure which we ascribe to time – the fact that time is a linearly ordered medium, with a metric grid imposed on it by the accepted calendar (manifest in our language through our ways of referring to particular times and dates, often with the help of calendar-related predicates like *day, week, month, year, ...*) An example of one such mode of specifically temporal reference is the possibility of using the phrase *on Sunday* to refer to the last Sunday before the utterance time, or alternatively to the first Sunday after it (with the tense of the sentence usually disambiguating between these alternatives). A systematic study of the range of referential possibilities for temporal adverbs is instructive (as well as indispensable for practical needs of computational linguistics), but it is not a matter we pursue here.

calendar predicates

The second point is one we need to consider more closely. It concerns the way in which the referent of a temporal adverbial adjunct gets connected with the information provided by the rest of its clause. There are two aspects to this question. First, there is an issue of the syntax-semantics interface: how does the syntactic relation in which the temporal adverb stands to the remainder of the clause lead to its interpretation as temporal location predicate of the described eventuality? It is generally assumed that adverbial phrases are adjuncts, though there appears to be some degree of uncertainty about where such phrases are adjoined. But these details need not detain us, as long as we assume (i) that the constituent to which the adverbial is adjoined acts as a predicate of a certain argument and that the temporal locating adverb provides an additional predication of that argument, and (ii) that when the adjunction is to some syntactic projection of the verb, as it is in the sentences of (91), then this argument is the eventuality described by the verb.

(Temporal adverbials aren't always adjoined to a projection of the verb. For instance, in a construction such as *the news at 12.00* the PP *at 12.00* is adjoined to the NP *the news*. Here, the argument of the locating predication is the referent of this NP. However, in the remainder of this discussion we limit attention to the cases where the adverb serves to locate the eventuality described by the verb.)

The other aspect of the contribution which temporal adverbs make to eventuality location has to do with content and form of the predications that temporal locating adverbials express. In DRT-terms: what are the discourse referents and conditions which the adverb contributes to the DRS of its clause? Since the sentence DRSs to which we have already committed ourselves involve not only eventualities but also their location times, the first question we need to answer here is: should the adverb be construed as locating the eventuality by entering in relation to it directly, or does it do this via a relation with its location time? It is not easy to motivate an answer to this question. We have adopted the second option. For the somewhat complicated and partly theory-internal reasons for this decision see [Reyle *et al.* 2003]).

The contribution of a temporal locating adverb, then, takes the form of some relation between (i) its own referent and (ii) the location time of the described eventuality. To explore how this relation should be represented we need to look at some particular cases. It is advisable to begin with an adverb which does not have the form of a prepositional phrase; our choice is *yesterday*.

First some details concerning this particular adverb. *yesterday* is a deictic adverb. Normally it refers to the day preceding that on which the utterance containing it is made. (In special cases of indirect discourse – especially of so-called free indirect discourse – it may refer to the day preceding some past vantage point, but these we ignore; but compare the related remarks on shifted *now* in the next subsection.) We will represent this indexical information by introducing a discourse referent t_y to represent this day, together with certain conditions which determine how this day is determined in relation to n . To this end we make use of a partial functor DAY-OF which maps any time t that is included within some calendar day onto that calendar day, as well as of a predicate DAY which is true of those and only those periods of time which are calendar days. (Exactly what people understand by “day” may be open to some variation. For simplicity we assume that a calendar day runs from midnight to midnight.)

So much for the particularities of *yesterday* as distinct from other temporal adverbs. What is still missing is the relation between the discourse referent t_y which represents its referent and the discourse referent t_{loc} for the location time of the eventuality. Let us focus on the sentence in (91) which begins with *yesterday*. (That is, the sentence *Yesterday Fred bought a lawn mower*.) In this case we obtain an intuitively correct representation of the truth conditions of the sentence if we assume that the relation is that of inclusion of the location time within the adverb time: “ $t_{loc} \subseteq t_y$ ”. Together with what has already been assumed about the representation of tensed sentences and the special conditions connected with the reference of *yesterday* this condition leads to the representation in (92)

$$(92) \quad \boxed{\begin{array}{l} n f z e t_{loc} t_y \\ \text{Fred}(f) \\ \text{lawn mower}(z) \\ t_{loc} < n \\ \text{DAY}(t_y) \\ t_y \supset \text{DAY-OF}(n) \\ t_{loc} \subseteq t_y \\ e \subseteq t_{loc} \\ e:\text{buy}(f,z) \end{array}}$$

(The symbol \supset denotes the relation of “abutment”. An interval t_1 abuts an interval t_2 if (i) t_1 lies entirely before t_2 , and (ii) there is no interval t_3 such that t_1 lies entirely before t_3 and t_3 lies entirely before t_2 .)

Is the condition “ $t_{loc} \subseteq t_y$ ” incidental to this particular sentence, in which a described event is located by the adverb *yesterday*? The answer is no. “ $t_{loc} \subseteq t_y$ ” is the condition which links the referent of the temporal locating adverb to the location time in all cases where the adverbial is adjoined to a projection of the verb. This claim may well seem counterintuitive and we need to consider a couple of other cases to show why it can be upheld.

Adverbials which look at first blush like counterexamples are PPs beginning with the prepositions *before* and *after*. Consider the sentence *After the exam Fred bought a lawn mower*. Isn’t the relation between t_{loc} and t_{adv} temporal succession in this case, rather than inclusion? The reason why we maintain that this is not so rests on a view of the semantics of locating PPs which has been proposed in connection with adverbials of spatial location, but which, we believe, applies equally to those which locate in time. For spatial PPs, such as, say, *above the cupboard*, *in front of the cupboard* or *in the cupboard*, it has been suggested [ref.frag Bierwisch] that they refer to a certain *spatial region* and locate the relevant entity as lying within this region. The region is determined as one which stands to the referent of the preposition-governed NP in a relation expressed by the given preposition. For example, in the case of *above the cupboard* the region consists of portions of space which are encountered when one moves vertically upwards from any part of the top of the cupboard. (In normal situations, where the cupboard is indoors, it is the space between the cupboard and the ceiling.) Similarly for *in front of the cupboard*, *in the cupboard* and so on.

On this view the adjunction of a spatial location PP involves two relations linking the referent of the NP it governs to the entity which it serves to locate (i) the relation expressed by the preposition, which holds between the referent of the NP and the region denoted by the PP as a whole, and (ii) the relation of spatial inclusion between that region and the entity that is being located; this second relation is the semantic correlate of the syntactic relation between adjunct and adjunction

site.²⁶

Not only do we endorse this proposal about the interpretation of spatial PPs, we also propose that the same analysis be adopted for PPs which express temporal location. According to the extended proposal the PP *after the exam* denotes a certain region of time – an interval which extends from the exam into the future, with an intrinsically vague upper bound – and when the PP is used in the way it is in (91), i.e. as locating predicate of the described event, it imposes a locating constraint on this event via the condition that the event’s location time is included in the temporal region denoted by the PP.

Instead of presenting the DRS for the sentence *After the exam Fred bought a lawn mower*, itself we give, in order to catch two birds with a single DRS in (92.b) the representation of a sentence in which this PP serves to locate a state rather than an event. This sentence is given in (92.a) – the VP *have a headache* is generally assumed to have stative aspect.

(93) a. After the exam Fred had a headache.

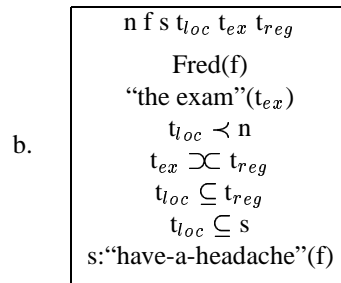

The present treatment of the semantics of temporal adverbials has one consequence which deserves special mention in view of the amount of attention which this matter has received in the literature. To the sentence *Yesterday Fred had a headache*, our treatment assigns truth conditions according to which the state of Fred having a headache is merely required to overlap with yesterday. Thus the analysis does not require that the headache lasted all day. For the present example this seems to be all to the good, but we hasten to add that the issue is more involved than this one example reveals.

We conclude this discussion of the role of temporal adverbials with four remarks of a more general methodological nature.

1. As the interaction between times and adverbs has been analysed here, it involves a combination of several constraints on one and the same entity (viz. the

²⁶Note that for a PP whose preposition is *in* (such as *in the cupboard*) this analysis has a semblance of redundancy, since inclusion is expressed by the preposition as well as by the syntactic adjunction configuration. But of course this incidental duplication does not speak against the proposal as such.

location time represented by the discourse referent t_{loc}), with one constraint contributed by the adverb and the other by tense. This means in essence that the mechanism of tense-adverb interaction involves a form of semantic unification. In fact, it was because of its unification-like character that the analysis of this interaction has had a decisive influence on DRT's general conception of the syntax-semantics interface.

2. A typical feature of unification is that it can fail when the constraints that need to be unified are incompatible with each other. Interactions between tenses and temporal adverbs manifest this typical feature of unification-based processes too. An example is the sentence in (94).

(94) Yesterday Fred will buy a lawn mower.

Here the constraint imposed on t_{loc} by *yesterday* requires it to precede *n*, while the constraint imposed by the future tense forces it to follow *n*. Consequently interpretation aborts, with the effect that the sentence is felt to suffer from a special kind of "semantic ungrammaticality".

3. So far we have considered a couple of examples (those in (85)) which demonstrated the dynamic properties of tense (and especially its backwards dynamic, or "anaphoric" properties) and after that a number of examples where temporal location is constrained by a clause-internal adverb (and where the constraints imposed by adverb and tense have to be consistent). What happens in situations where both those mechanisms are applicable? The unification perspective would suggest that the same consistency constraints apply in these cases too: if there is a conflict between the constraints imposed by the adverb and the relation in which the location time stands to the context-supplied reference time, then the sentence tends to be uninterpretable or at least to be judged infelicitous. One type of example of this are sentences in which the adverb denotes a time which is located well before the contextual reference time and where the tense is a simple past. Such sentences often sound bad, or seem incomprehensible. (In such cases the past perfect is usually required, or at least it is preferred over the simple past. The reasons for this will become clear when we discuss our next example.)

But although the constraints contributed by reference time and adverb often seem to lead in such cases to conflicts which render the sentence infelicitous, there is nevertheless an asymmetry between them. Adverbial constraints tend to overrule contextual constraints. This is no surprise given that the principles which govern adverbial reference are much more clearly defined (and therefore less amenable to reinterpretation on the spur of the moment) than those which govern the links between the new sentence and its context. The upshot of this is that to the extent that the system of temporal location we find in a language like English can be regarded as unification-based, the unification involved is one that allows for constraint pri-

oritisiation. In other words, we are dealing with a form of default unification (cf. [Briscoe *et al.* 1993, Lascarides and Copestake 1999].)

4. The interaction between tense and temporal adverb has also been of central importance for the overall structure of the DRT-account of temporal reference that is the particular topic in the present section. As we noted at the beginning of this section, one of the reasons why temporal logics do not provide a satisfactory framework for the analysis of temporal reference in natural language is their lack of any devices for explicit reference to times. We cited temporal adverbs as salient examples among the expressions of natural languages for which it is obvious that they do explicitly refer to times. The way in which adverbs and tenses work together in locating eventualities along the time axis is important in this connection insofar as it indicates that treating tenses and temporal adverbs separately, using one representational framework to deal with tense and another to deal with adverbs, would be a hopeless undertaking. We need representations which contain terms standing for times to represent the contribution of the tenses no less than we need such terms to represent the contributions that are made by the adverbs.

Perspectival Shift and the Two-Dimensional Theory of Tense

So far we have considered a couple of tenses which can be analysed without reference to temporal perspective points. (Other tenses which allow for a similar analysis are the present tense and simple future tense of English (recall (86)) and similarly the *présent* and the *futur* of French.) But this is not true in general. That there are tenses which require a more complicated analysis is arguably the most salient feature of Reichenbach's theory of tense. Reichenbach showed that when a sentence in the simple past is followed by a sentence in the past perfect, the eventuality described by the latter is typically understood as preceding the former: the first sentence provides a "past reference time" for the interpretation of the past perfect of the second sentence and the past perfect locates its eventuality in the past of this past perspective time. The following example illustrates this principle. At the same time it shows why it is necessary to distinguish between temporal perspective time and reference time.

(95) Luigi was writing to the Department Chairman. He had applied for the job without much hope. But the Committee had invited him for a talk, he had given a perfect presentation, they had offered him the job and he had accepted. Now he was worried about what he was going to teach.

(95) begins with a sentence S_1 in the past progressive. S_1 is followed by a sequence of five sentences S_2, S_3, S_4, S_5, S_6 in the past perfect. The passage ends with a sentence S_7 in the simple past.

The first aspect of (95) that matters here is the interpretation of the past perfects in S_2 - S_6 . We start by looking at S_2 . In the context provided by the sentence S_1

which precedes it S_2 is understood as describing an event e_2 situated in the past of the location time t_1 of the eventuality s_1 described by S_1 . The observation that this is so, we just noted, was the central insight which led Reichenbach to his “two-dimensional” theory. In the present account, Reichenbach’s analysis of the past perfect has been taken over, except that here it is the temporal perspective time which plays the intermediate role between event time (i.e. our location time) and utterance time. This role cannot be played by what we have called the temporal reference time, as the reference time may be needed in a different capacity. To see this consider the second past perfect sentence of (95), i.e. S_3 . The interpretation of this sentence involves temporal location of the described event e_3 in the past of t_1 , and we may assume that the same mechanism is responsible for this that also locates e_2 before t_1 . On the other hand e_3 is understood as following e_2 , and the mechanism responsible for this is strongly reminiscent of what we saw in our discussion of (85.b). There the second of a pair of sentences in the simple past was interpreted as describing an event whose location time stood in a relation ρ of temporal succession to the location time t_1 of the event described by the first sentence, and in the interpretation of the tense of the second sentence t_1 was assumed to play the role of temporal reference time. We claim that a similar relationship holds between the location times of the events introduced by the second and third sentence of (95), and that like in the case of (85.b) the location time of S_2 acts as reference time in the interpretation of S_3 .

According to this analysis the interpretation of S_3 involves both a temporal reference time and a perspective time. Since the new location time t_3 is assumed to stand to reference time and perspective time in distinct relations – the relation to the reference time we have assumed is that of the reference time preceding t_3 , whereas t_3 precedes the perspective time, as it does for any past perfect – reference time and perspective time must be distinct. Hence the need for two notions rather than one.

Note that for each of the sentences S_3, \dots, S_6 reference time and perspective time are distinct. Moreover, while the perspective time remains constant, the reference time changes from sentence to sentence. This is a typical feature of extended flashbacks. These remarks evidently do not solve the problem how perspective times are chosen in general. For one thing, not every sequence of sentences in the past perfect following a sentence in the simple past constitutes a single extended flashback. Sometimes we find flashbacks within flashbacks, and in such cases the perspective time for the sentence or sentences of the embedded flashback is not the location time of the last simple past sentence but that of an earlier past perfect sentence. However, the question when we are dealing with a single flashback and when with an embedding of one flashback within another once again depends on factors on which the account we have sketched has no purchase. Thus the choice of perspective time is (for the reason given as well as others) a problem that our account can deal with only to a first approximation – just as we found this to be the case for the specification of the relation ρ .

In (96) and (97) we present the relevant stages in the interpretation of S_3 . The DRS in (96) gives complete presentations for S_1 and S_2 together with a preliminary representation for S_3 which displays the two presuppositions triggered by the past perfect. One of these concerns the relation to the reference time and is identical with the presupposition of (87), while the other has to do with the relation to the perspective time.²⁷

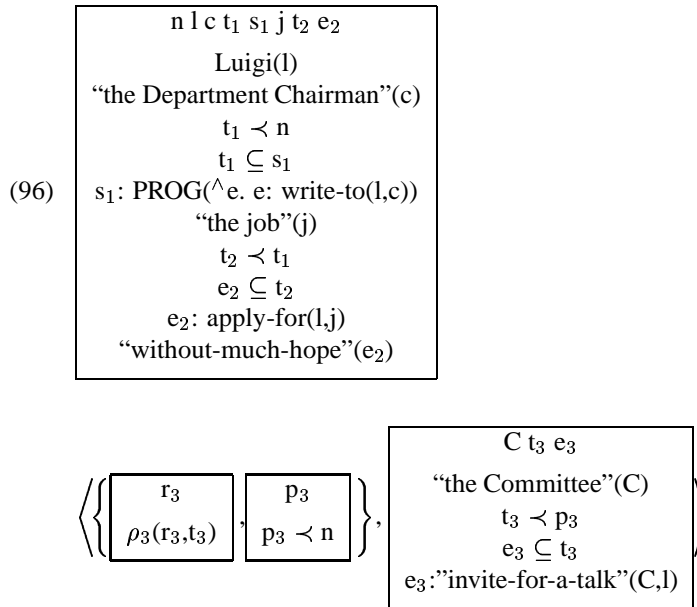

To obtain the final representation of the first three sentences of (95) the two presuppositions of (96) must still be resolved. How they should be resolved has already been stated: r_3 must be identified with t_2 and p_3 with t_1 , while the relation ρ is to be specified as “<”, so that the condition “ $\rho_3(r_3, t_3)$ ” turns to “ $t_2 < t_3$ ”. These resolutions lead to the representation in (97).

²⁷N.B. In (96) we have simplified the representation of anaphoric pronouns (such as the *he* of S_2) by substituting the discourse referents for their anaphoric antecedents into their argument positions (instead of introducing a distinct discourse referent for the pronoun together with an equation which enforces coreference between it and the antecedent discourse referent). This too is a practice which from now on we will adopt whenever it suits us.

	n l c t ₁ s ₁ j t ₂ e ₂ C t ₃ e ₃
	Luigi(l)
	“the Department Chairman”(c)
	t ₁ < n
	t ₁ ⊆ s ₁
	s ₁ : PROG(^e. e: write-to(l,c))
	“the job”(j)
	t ₂ < t ₁
(97)	e ₂ ⊆ t ₂
	e ₂ : apply-for(l,j)
	“without-much-hope”(e ₂)
	“the Committee”(C)
	t ₁ < n
	t ₃ < t ₁
	t ₂ < t ₃
	e ₃ ⊆ t ₃
	e ₃ : “invite-for-a-talk”(C,l)

The interpretation of the sentences S₄-S₆ proceeds in the same way as that of S₃ and requires no further comment. But the last sentence S₇ of (95) presents a new problem, which is connected with the occurrence in it of the word *now*. This is a problem of a kind which we have not yet encountered and which merits separate discussion.

Apart from the question raised by *now*, the representation of S₇ also presents some difficulties which are orthogonal to the concerns of this section. These have to do with the embedded question *what he was going to teach*. We finesse them by considering instead of S₇ the simpler sentence

(98) Now he was worried.

We will refer to this sentence as S₇^l. (So the revised version of (95) consists of the sentences S₁,S₂,S₃,S₄,S₅,S₆,S₇^l.) Looking at S₇^l rather than S₇ allows us to focus attention on the issue that matters in the present context.

The problem arises from the fact that in S₇^l *now* occurs in the presence of the past tense. It has been claimed that *now* is an indexical adverb which always refers to the time at which it is uttered ([Kamp1971]). If this were true without qualification, then the interpretation of S₇^l should abort, since the constraints imposed on its location time t₇ by tense and adverb would be incompatible. The fact that in the given context S₇^l is not uninterpretable indicates that (at least in this type of context) *now* can be used to refer to times which lie in the past of the utterance time.

An inspection of those cases where *now* can refer to a time other than the one at which it is actually uttered suggests that it is referring in such cases to a time that can be regarded as a kind of “displaced utterance time” (or, in slightly different

terms, to the time of a “view point”, or “perspective” which has been shifted away from the real utterance time).²⁸

The appeal to “shifted view points” may have a plausible ring to it, but as it stands it is too vague to serve in a formal theory of temporal interpretation of the kind we are pursuing. So we are facing the question: How can this notion be made more concrete? [Kamp and Reyle1993], following an earlier proposal in the unpublished manuscript [Kamp and Rohrer1983b], proposes that the perspectival shifts that are involved in the reference of *now* to a time in the past of n are the same as those involved in the interpretation of a past perfect sentence (viz. as placing its eventuality in the past of a time that itself is in the past of the utterance time) and thus that the same notion of perspective time we have just been invoking for the interpretation of S_2 - S_6 is also the one to be invoked in the interpretation of S'_7 . According to this proposal the interpretation of *now* involves two possibilities, as stated in (99).

- (99) *now* either refers to the utterance time, or else to a time which plays the role of perspective time in the interpretation of the sentence to which it belongs.

Given this assumption it follows that the interpretation of S'_7 follows a pattern that closely resembles that of S_2 - S_6 . Again the interpretation requires the choice of a perspective time and once again the intuitively right candidate for this is the location time t_1 introduced in the interpretation of S_1 . We assume therefore that the preliminary representation of S'_7 involves the same pair of presuppositional components that are also part of the preliminary representations of S_2 - S_6 . This representation is given in (100).

$$(100) \left\langle \left\{ \left[\begin{array}{c} r_7 \\ \rho_7(r_7, t_7) \end{array} \right], \left[\begin{array}{c} p_7 \\ p_7 \prec n \end{array} \right] \right\}, \left[\begin{array}{c} t_7 \text{ e}_7 t_{now} \\ t_7 \subseteq s_7 \\ r_7 \subseteq t_7 \\ t_{now} = p_7 \\ t_7 \subseteq t_{now} \\ s_7: \text{“be-worried”}(l) \end{array} \right] \right\rangle$$

Resolution of the perspective time p_7 should, we said, again be to t_1 . What about the reference time r_7 ? Before we try to answer this question let us see what we know about the location time t_7 of the state which S_7 describes. Identifying p_7 with t_1 means that *now* is construed as referring to t_1 . At the same time *now*, as a temporal adverb, serves as a constraint on the new location time t_7 ; thus $t_7 \subseteq t_1$. So all that we need and can hope for from the resolution of the presupposition concerning r_7 is that the result is consistent with this interpretation. As before,

²⁸For reasons which we make no effort to explain here such shifts seem to occur almost exclusively in the direction of the past; cases where *now* refers to some time in the future of the utterance time appear to be marginal. But see [Sandström1993].

resolution of this presupposition involves (i) specifying ρ_7 , and (ii) finding an antecedent for r_7 . As regards (i) note that tense and aspect of S_7' are like those of the second sentence of (85.a): the sentence has stative aspect and its tense is in the simple past. This suggests that once again the relation should be inclusion: $r_7 \subseteq t_7$. This leaves r_7 . It is clear that the only possible antecedent for r_7 within the context provided by S_1 - S_6 which is consistent with the constraints that have been established already is the location time t_1 . Resolving r_7 accordingly means that this time reference time and perspective time both get identified with t_1 and thus that they coincide. (101) gives (in abridged form) the representation for (95) that results from these resolutions of the two presuppositions of (100).

	n l c t ₁ s ₁ j t ₂ e ₂ C t ₃ e ₃ ... t ₅ t ₆ e ₆ t ₇ e ₇ t _{now}
	Luigi(l)
	“the Department Chairman”(c)
	t ₁ < n
	t ₁ ⊆ s ₁
	s ₁ : PROG(^e. e: write-to(l,c))
	“the job”(j)
	t ₂ < t ₁
	e ₂ ⊆ t ₂
	e ₂ : apply-for(l,j)
	“without-much-hope”(e ₂)
	“the Committee”(C)
	t ₁ < n
	t ₃ < t ₁
	t ₂ < t ₃
	e ₃ ⊆ t ₃
	e ₃ : “invite-for-a-talk”(C,l)
	:
	t ₆ < t ₁
	t ₅ < t ₆
	e ₆ ⊆ t ₆
	e ₆ : accept(l,j)
	t ₇ ⊆ t ₁
	t ₇ < n
	t _{now} = t ₁
	t ₇ ⊆ s ₇
	s ₇ : “be-worried”(l)

(101)

The choice of t_1 as reference time for S_7' indicates that the determination of reference times is in general more complex than was revealed by the examples that have so far been discussed in this section. Choosing the location time t_1 of

the first sentence S_1 after the sentences S_2, \dots, S_6 have intervened reflects the perception that the flashback S_2, \dots, S_6 has come to an end and that S_7' returns to the point of the story which had been reached with S_1 and then interrupted. Here we see a correspondence between choice of reference time and narrative structure, a correspondence which once more transcends the scope of the account as it has been presented.

Discussion: Resolution of Reference Time, Perspective Time and their Relations; Perspective Time and Perspectival Shifts; A General 2-Dimensional Theory of Tense

The treatment of (95) which we have presented here leaves some questions unanswered and suggests some new ones of its own.

1. First, as we have stated it our account of (95) contains a number of loose ends. The most serious of these concern (i) the principles governing the identification of reference time r and perspective time p ; and (ii) the specification of the relations in which r and p stand to location time and utterance time. As we noted in the discussion after our analysis of (85), a central problem, and one on which the present account has nothing to say, is that the specification of ρ often depends on other, “pragmatic” factors besides those we have considered. In our discussion of the interpretation of S_3 - S_6 of (95) we observed that the same applies to the choice of perspective time and we concluded in connection with our discussion of S_7' that the choice of reference time gives rise to similar problems. The same proves to be true with regard to the resolution of r and p . It appears that if we want to make substantial further progress on these problems we need a framework in which these other factors can be treated in a systematic way. As it stands DRT does not provide this framework.

2. Another question which naturally arises in the context of what we have said about (95) concerns the need for the notion of perspective time. We argued in relation to the non-initial sentences of extended flashbacks – in the case of (95): sentences S_3, \dots, S_6 – that their interpretation involves linking to two different times from the context. Since the reference time cannot be responsible for both these links at once, we said, a further notion is needed. But does that really follow? There might be an alternative way of dealing with this problem, viz by maintaining that the past perfect (and possibly other tenses as well) requisitions the reference time for its own needs, and thereby creates the possibility of choosing a further, “secondary” reference time, which can take over the task that is accomplished by the “primary” reference time in cases where the tense does not come with such special needs (e.g. when it is a simple past). On the face of it this may seem to be nothing more than a superficial variant of the account we have presented. But it is connected with a more substantive issue. Even if we adopt this variant there is still

a need for some notion of perspective time in connection with “pseudo-indexical” uses of indexical adverbs, like that of *now* in the last sentence of (95). But shifted references of *now* and run-of-the-mill past perfects would no longer be represented as involving one and the same conceptual operation (that of choosing a past perspective point). And this is a disentanglement that some would welcome. It may be added in this connection that not all cases of shifted reference by indexicals appear to be of the same kind. For instance, there are subtle differences between the kind of perspectival shift we find with a word like *now* and the shifts involved in shifted reference of adverbs like *yesterday* or *tomorrow*. (See [Kamp and Rohrer1983b]). How many different notions of perspective will be needed eventually to do justice to these differences remains open.

3. The examples we have discussed in detail involved only two tense forms, the simple past and the past perfect. (The past progressive, we said, should be analysed as a combination of the simple past and an aspectual operator which transforms a verb into its progressive form.) And for only one tense form, viz., the past perfect, did our analysis require perspective time. It is a natural question for which other tenses (if any) perspective times are needed as well. Answers to this question lie somewhere between a lower and an upper bound. The lower bound consists of a small set of tenses which includes besides the past perfect also the the “future of the past”, as we find it in the second sentence of (102).

(102) On the 3rd Powell arrived in Brussels. On the 4th he would be in London and on the 5th in Berlin.

(With such future-of-the-past sentences the location time of the described eventuality follows the perspective time while the perspective times precedes n.) The upper bound is the set consisting of all tense forms. A proposal to the effect that perspective time is involved in the analysis of all tenses can be found in [Kamp and Reyle1993] (and in the unpublished [Kamp and Rohrer1983b] for the tenses of French). Tenses which in a lower bound account would be treated as not involving perspective time (as one assumed for the simple past in the analyses given here) are analysed in this proposal as locating the perspective time at the utterance time. Since the proposal uses perspective time both to account for the tenses and for perspectival reference shifts for words like *now* (just as was assumed above), a consequence is that the simple past tense is ambiguous between an analysis where the perspective time coincides with n – see the treatment of (85.a,b) above – and one where the perspective time lies in the past of n and coincides with the location time – see the above treatment of sentence S_7' . This consequence has been perceived as undesirable and seen as a further argument against assuming that perspective times serve in this dual capacity. A different explanation of the possibility of shifted reference of words like *now* can be found in [?].

The questions raised under points 1.-3. above are of prime importance for linguistics. But they carry no implications for the form of the DRS-language that

is needed to represent temporal information. As can be seen from the examples we have presented, all reference to *r* and *p* has disappeared from the representation when the DRS for a sentence or discourse has reached its final form. Since the form of these final DRSs – i.e. of the “formulas” of our DRS language – is independent of the details of DRS construction in which the alternative accounts alluded to in the discussion above differ from the account we have presented, these details will be of lesser interest to those readers who are primarily concerned with form and meaning of the final representation language.

Temporal Quantification

So far we have looked at the interaction between tenses and temporal “locating” adverbs. These adverbs, we argued, denote certain periods (or “regions”) of time, within which the location time of the described eventuality is situated. But not all temporal adverbs function this way. Just as among NPs we find besides the definite and indefinite ones, which have some sort of referential status, also quantificational NPs, so we find quantificational temporal adverbials besides those locating adverbs which contribute to the interpretation of the sentences in which they occur just one particular time. Quantificational temporal adverbials come in two main forms: (i) prepositional phrases whose NP is quantificational, such as *on every Sunday*, *on most Sundays between June 15th and August 31st*, *after many parties thrown by Mary*, etc.; and (ii) quantifying adverbs such as *often*, *always*, *usually*, *regularly*.

The question how sentences containing quantifying temporal adverbials should be represented is somewhat easier for adverbials of type (i). What we would expect in this case is that the representation of a sentence with a quantifying temporal PP stands to that of a corresponding sentence in which the quantifying NP of the PP has been replaced by a referential NP in the same relation that, say, the representation of a sentence with a quantificational subject stands to that of the sentence we get by replacing this subject NP by a referential one. Compare for instance the following four sentences.

- (103) a. The Dream of Gerontius is boring.
 b. Every choral work of Elgar is boring
 c. On Sunday Mary went to see her aunt.
 d. On every Sunday between June 15-th and August 31-st, 2001 Mary went to see her aunt.

(104.a) and (104.b) give DRSs for (103.a,b) in accordance with the proposals of Sections 2 and 3.1 and (104.c) gives a representation of (103.c) according to the proposals that have already been made in the present subsection:

- (104) a.

d
“The-Dream-of Gerontius”(d)
boring(d)

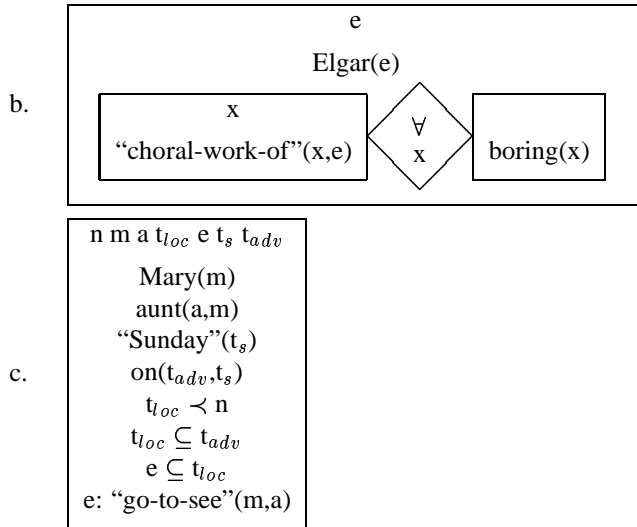

If the representation for (103.d) is to be related to (104.c) in the way that (104.b) stands to (104.a), it should be something like the one given in (105).

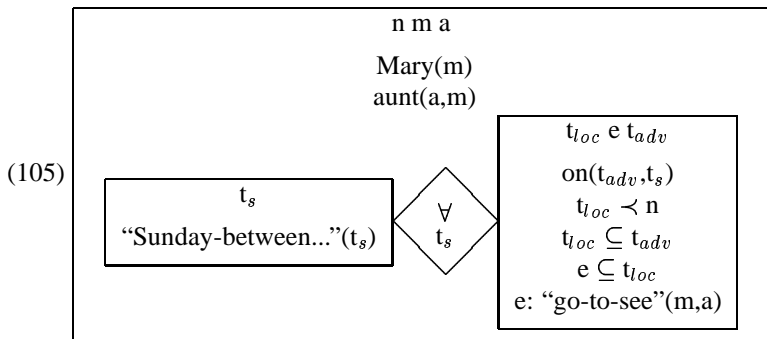

(105) is adequate insofar as it captures the truth conditions of (103.d) correctly. But it provides no insight into the question which has been high on our agenda so far: how do tense and temporal adverb interact to produce such interpretations?

Intuitively it seems clear that the tense of (103.d) is relevant to the interpretation of the sentence insofar as it locates the possible values of the sentence-internally bound variable t_{loc} in the past of n . In other words, whenever the quantificationally bound variable t_s takes a value satisfying the restrictor predicate *Sunday between 15-06-2001 and 31-08-2001*, and t_{loc} is a time included within the time t_{adv} (which in this case will coincide with the value of t_s), then t_{loc} must precede n . This is consistent with speakers' intuitions about use and meaning of (103.d): if we assume that (103.d) is uttered at a date after 31-08-2001 (such as, say, March 2003), in which case all values for t_{loc} which satisfy the restrictor predicate also satisfy the constraint imposed by the past tense (i.e. are in the past of n), then

the sentence is used felicitously. But when the sentence is uttered at some time before this date, then some values for t_{loc} will not lie before n ; and, indeed, such an utterance would be perceived as incoherent or strange. By the same token, (106) would be incoherent at any time when (103.d) can be used coherently.

(106) On every Sunday between June 15th and August 31st, 2001 Mary will go to see her aunt.

In the light of these observations, together with what has been said about the interaction between tenses and referential temporal adverbs earlier, the following would appear to be a natural hypothesis about the way in which the tenses of sentences like (103.d) and (106) and the adverbs of these sentences interact:

(107) The tense contributes its constraints to the nuclear scope of the duplex condition introduced by the quantificational adverb.

In fact, we already used this hypothesis in the construction of the DRS in (105), where the condition “ $t_{loc} < n$ ”, contributed by the simple past of (103.d), is one of the conditions in the nuclear scope DRS.

Unfortunately, however, (107) isn't correct in general. It fails for sentences in the present tense. Consider (108).

(108) This week the patient is checked every half hour.

Let us assume that (108) is uttered on a Wednesday. It then asserts that at half hourly intervals throughout the week to which the given Wednesday belongs there are occurrences of events of the described type (i.e. of the patient being checked). Some of these events are situated in the past of the utterance time, some of them in the future of it, and perhaps one is going on at the very moment when the statement is made. Though we haven't discussed the constraints imposed by the English present tense explicitly, we trust that the reader is prepared to accept this much: not all these different temporal relations in which patient-checking events stand to the utterance time n are compatible with the constraints it imposes. (This follows in particular if we assume that the contribution of the present tense is as given in (86). In actual fact the English present tense covers a somewhat wider set of possibilities than (86) allows for, but the present point is not affected.) If not all the events of which (108) asserts that they took, take or will take place satisfy the constraint which the present tense imposes, then (107) is refuted. What then is the way in which tense and quantificational temporal adverbs interact? And in particular, how can we explain that (108) is an acceptable sentence? The answer we propose is the following:

(109) In quantificational statements like those in (103.d), (106) or (108) the tense of the sentence locates the temporal interval within which the times from the domain of the quantification are included.

In the case of (103.d) this interval is located entirely in the past of the utterance time, whence a past tense is appropriate there. Likewise, with future tense substituting for past tense, for (106). In the case of (108) the interval straddles the utterance time, and this requires the present tense.

To find a justification for (109) we may look in either or both of two directions. The first involves the assumption that duplex conditions can function as characterisations of eventualities. We refer to such eventualities as “quantificational states”. On this assumption the duplex condition in (105) can be construed as the description of a state s as shown in (110):

state ! quantificational

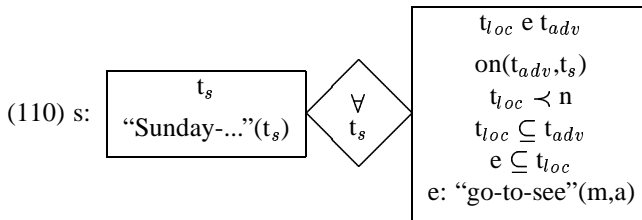

The full representation of (103.d) of which (110) is part includes in addition the introduction of s as a member of its DRS universe. Moreover, just as any other eventuality, s is assumed to come with its own location time t , and it is this location time that is assumed to be the time that is constrained by tense. With these assumptions (105) turns into (111):

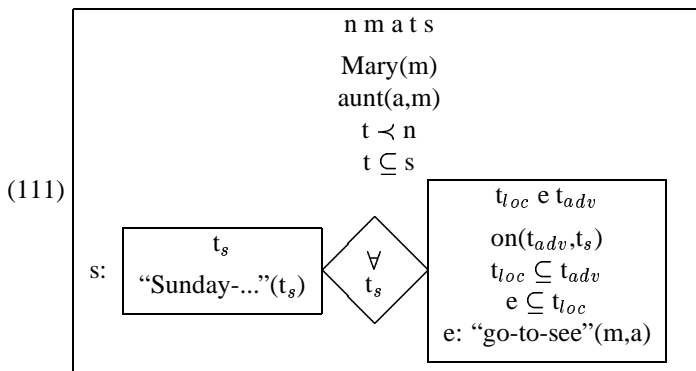

Like (105), (111) correctly captures the truth conditions of (103.d). But we aren’t out of the woods yet. This becomes clear when we consider sentences in which the quantificational temporal adverb is in the scope of another temporal adverb, as it is for instance in (108). In (108) the time specified by the “outer” adverb *this week* functions as an additional restriction on the quantification expressed by the “inner” adverb: we are talking about events one half hour apart throughout the week containing the utterance time.

In order to keep the connection with the representations of adverbial quantifications we have considered so far (i.e. (105) and (111)) as transparent as possible, let us look, not at (108), but at the following variant of (103.d):

(112) Last summer Mary went to see her aunt (on) every Sunday.

Suppose we try to construct a representation for (112) along the lines of (111). The additional matter we now have to deal with is the adverb *last summer*. In the light of what we have said above about how referential temporal adverbs contribute their semantics, *last summer* should constrain the relevant location time as included within the period t which the adverb denotes. (Somewhat simplified, if t_{ls} is the summer of the year preceding the one in which the utterance is made, and t is the relevant location time, then the constraint contributed by the adverb should be the condition " $t \subseteq t_{ls}$ ".)

What is the relevant location time in this case? It is easy to see that it cannot be the one which in (110) and (111) appears within the nuclear scope of the duplex condition. For that would clearly lead to the wrong truth conditions. The only other possibility is that the relevant location time is the location time t of the quantificational state s . However, as it stands the condition " $t \subseteq t_{ls}$ ", in which t is this location time, does not give us what we want either. For the only conclusion which it allows us to draw is that s overlaps with the denotation of *last summer*. And that is too weak. What we want is this: the temporal quantification is restricted to the period denoted by *last summer*.

To get this stronger implication we need a pair of further stipulations:

- (113) (i). The duration of a quantificational state coincides both with its location time and its adverb time; moreover,
 (ii). the quantification which characterises a quantificational state is by definition restricted to the state's duration.

Given (113) we get the following "upgraded" representation for (112):

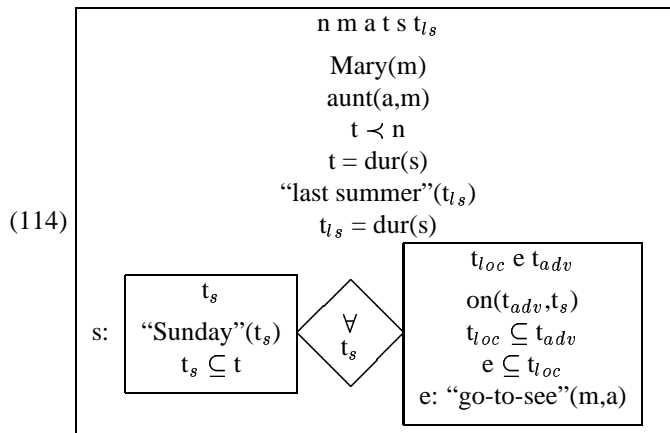

But what is the justification for the assumptions made in (113)?

We can get closer to such a justification by following the second one of the two directions hinted at. This direction has to do with the contextual constraints that

quantification has been observed to be subject to in general. We noted in Section (3.3) that quantification often involves tacit restrictions and we followed the proposal of [von Stechow 1994] and others to represent these in the form of an additional restriction on the bound variable of the quantification, involving an initially unspecified predicate C. C is introduced as part of a presupposition which requires resolution in the light of contextual information.

When the variable bound by the quantifier ranges over times, the resolution of C often takes on a special form: that of a “frame interval” within which the values of the bound variable are temporally included. (In such cases resolution of C may involve other factors as well, a point to which we turn below.) Moreover, when the quantificational temporal adverbial is within the scope of another temporal adverb – as it is in (108) or (112) – it is the outer adverb which specifies the frame interval for the quantification expressed by the inner adverb. (In such cases an expression belonging to the sentence itself accomplishes what in its absence would be the task of the context. Recall what was said on this score in the section on tenses and locating adverbs.)

In this way the constraint contributed by the outer temporal adverb becomes part of the restrictor of the quantification, which is where it is wanted. (115.a) gives the representation of (112) before resolution of the restrictor predicate C and (115.b) the result of resolving C to the referent of *last summer*.

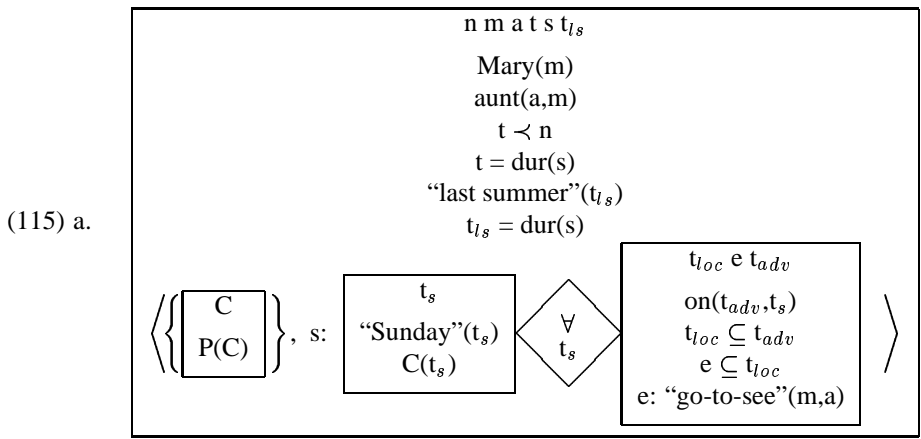

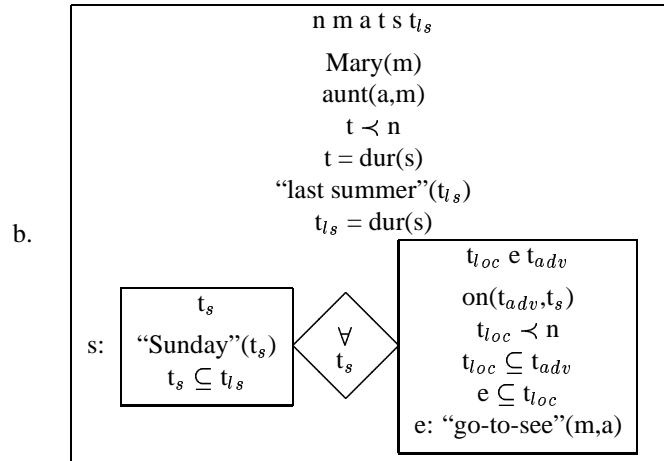

Like (114), (115.b) renders the truth conditions of (112) correctly. But once more we need to ask: what could be the deeper justification for the assumptions on which the new representation rests? That the outer adverb can serve as a source for the specification of C seems plausible enough. But even if we assume that it can serve this purpose, that is not the same thing as showing that it *must* be understood in this capacity. Perhaps it could be argued that this is the only meaningful function that the outer adverb could have in a sentence like (112), so that the necessity of its contribution to the restrictor of the adverbial quantification becomes an instance of "full interpretation": each potentially meaningful constituent of a sentence must make a meaningful contribution to the whole. But it is unclear to us how this intuitive principle could be made more precise.

The point we have reached can be summarised as follows. We have looked at two mechanisms which could be held responsible for the interaction between quantificational temporal PPs, tenses and other temporal adverbs: (i) "reifying" the quantifications expressed by quantifying temporal PPs as "quantificational states" whose types are given by the duplex conditions representing the quantifications, and interpreting tense and outer adverb as constraints on this "state"; and (ii) treating the outer adverb as an additional restriction on the temporal quantification expressed by the PP. Neither of these mechanisms could account for the facts we observed without further assumptions, however, and even when the two are combined, extra assumptions are needed for which no compelling justification has yet been offered. We must leave the question of the interpretation of sentences like (112) in this unsatisfactory state, as an example of the many problems in this domain that are still waiting for a solution.

Frequency Adverbs

So far we have considered quantificational temporal adverbs which have the form of PPs in which the preposition governs a quantificational NP. The interpretation of frequency adverbs such as *always*, *often* etc. runs along much the same lines. But here we encounter additional complications. First, there is the problem how material within the scope of the adverb is to be divided between restrictor and nuclear scope. (cf. e.g. [Rooth1992] for the effects of information structure). This is a problem about which much has been and is being written, but it falls outside the scope of this survey. A second problem has to do with the interpretation of the contextual predicate C. In discussing quantificational PPs we focussed on the interpretation of C as inclusion (of the values of the bound variable) within a certain frame interval. With frequency adverbs this aspect of the interpretation of C is equally important. But in addition quantification by frequency adverbials is affected by another element of indeterminacy, which also can be contextually resolved or reduced, and often is. This second indeterminacy concerns the “granularity” of the quantification. For an illustration consider the following sentence: granularity

(116) On Sunday Mary often called her aunt.

This sentence is ambiguous between an interpretation according to which there were many Sundays on which Mary called her aunt and a reading according to which there was a particular Sunday (e.g. the last one before the time on which the sentence was uttered) when Mary made many calls to her aunt. On the first reading the set of “cases” many of which are said to have been “cases when Mary called her aunt on Sunday” presumably consists of periods of the order of magnitude of a week. On the second reading the cases of which many are said to be “cases where Mary called” involve times of which a good many must fit within a single day. Part of what a speaker has to do when he has to assign meaning to sentences involving frequency adverbs is thus to form a conception of roughly what size periods are involved in the quantification it expresses. With nominal quantification the granularity question is normally resolved through the predication expressed by the nominal head of the quantifying phrase (cf. the noun *Sunday* in the quantifying NP of (103.d)), but with frequency adverbs granularity has to be determined by other means. For this reason the ambiguity we find in (116) is possible with the latter but not with the former. What general strategies are employed in arriving at granularity decisions when interpreting frequency adverbs is another question we can do no more than mention.

Negation

Sentence negation, as expressed in English by the word *not* (with or without do support), is among the operators of natural language which have a temporal and an aspectual dimension. As a rule, negation involves, implicitly or explicitly, some

“frame” interval within which the negated condition is asserted to be unrealised. For instance, the statement

(117) Mary didn't call on Tuesday.

is understood as claiming that within the period denoted by *Tuesday* the condition of Mary calling did not obtain; in other words, that within this period there was no event of Mary calling. It is natural to associate with this observation the assumption that negation also has an aspectual effect, viz that irrespective of whether the material in its scope is stative or non-stative, the negated clause describes a state - a state to the effect that the given frame interval does not include an eventuality described by the clause to which the negation applies.

To capture these intuitions we consider the option of analysing negation as an aspect operator “NOT” which, like the operator “PROG”, operates on properties of eventualities. The eventuality property is provided by the material in the scope of the negation – indeed, this perspective makes it natural to treat negation in a manner that is suggested by syntax for many of its actual occurrences - viz as a VP adjunct (nothing of the present proposal, though, really depends on this assumption.)

For the case of (117) the option gives rise to a representation of the following form:

$$(118) \quad \begin{array}{c} t \quad t'_{adv} \quad m \\ \text{Mary}(m) \\ \text{Tuesday}(t'_{adv}) \\ t < n ; t = \text{dur}(s) ; t'_{adv} = \text{dur}(s) \\ s:\text{NOT}(\wedge e.e:\text{call}(m)) \end{array}$$

The conditions $t = \text{dur}(s)$ and $t'_{adv} = \text{dur}(s)$ arise from the assumption that NOT has the properties of an adverbial quantifier and as such is subject to the same special constraints on the temporal location of the state it introduces as frequency adverbs like *always*, *often* or *never*.

(118) doesn't reveal much of the actual truth conditions associated with negation. This can be made more explicit via a meaning postulate for NOT, according to which the last condition of (118) can be written as in (119):²⁹

$$(119) \quad \begin{array}{c} t \quad t'_{adv} \quad m \\ \text{Mary}(m) \\ \text{Tuesday}(t'_{adv}) \\ t < n ; t = \text{dur}(s) ; t'_{adv} = \text{dur}(s) \\ s:\neg \begin{array}{c} e \\ e \subseteq \text{dur}(s) \\ e:\text{call}(m) \end{array} \end{array}$$

²⁹For more on meaning postulates, see Section ??.

In virtue of the condition $\text{dur}(s)=t$ we can replace $\text{dur}(s)$ by t . s has now become redundant. So we can eliminate all further occurrences of s , thus obtaining the reduced representation (120):

$$(120) \quad \begin{array}{|l} t \ t'_{adv} \ m \\ \text{Mary}(m) \\ \text{Tuesday}(t'_{adv}) \\ t < n ; t = t'_{adv} \\ \hline \neg \begin{array}{|l} e \\ e \subseteq t \\ e:\text{call}(m) \end{array} \end{array}$$

Although (120) is sufficient to capture the truth conditional content of (117), the alternative representations (118) and (119) are useful as well, in so far as they bring out the aspectual effect of negation and allow the rules which govern the temporal location of negation to be subsumed under the more general category of adverbial quantification. (120) should thus be considered as the result of a harmless simplification after a representation has first been constructed in the form given in (118), and then be transformed into (119) by application of the meaning postulate.

The present analysis brings out how negation can, through the ways in which it interacts with tense and temporal adverbs, produce an effect of temporal quantification. One consequence of this is that sentences containing negation expressed with the help of *not* often have the same truth conditions as sentences in which this negation is replaced by *never*. For instance (117) has the same truth conditions as

(121) On Tuesday Mary never called.

In fact, the two sentences may end up with the same semantic representations. Whether they do will depend on the exact treatment we adopt for the adverb *never*.

These proposals for treating negation are closely related to and in large part inspired by work of DeSwart, see [REFERENCES XXX].

Syntax and Semantics of the New Representation Language

Representating temporal information in the way which we argued to be necessary requires important extensions to the formalism which we had reached by the end of Section 3.1.³⁰ These extensions consist of

- new discourse referents for
 - points and periods of time,

³⁰Or alternatively, the extended formalisms of Sections 3.3 and 3.4. The extension described below is independent from those of 3.3 and 3.4.

- events, and
- states;
- a number of new predicates and functors in which entities of the sorts represented by the new discourse referents occur as arguments (as well as the atomic and non-atomic individuals exclusively considered hitherto). Among the predicates there are those which relate times and/or eventualities – the only ones we have had occasion to use here were \prec , \subseteq and \supset , but in general more are needed – as well as an open-ended number of predicates which relate eventualities to the entities of which we have been speaking throughout this chapter as (atomic and non-atomic) individuals. (These latter predicates, in which the eventuality argument is linked via a colon to the remainder of the predicational expression, are usually based on lexical verbs, although in the discussion of temporal quantification we also considered state predicates built from duplex conditions. More on lexically based eventuality predicates can be found in Section ??.)

From the point of view of predicate logic the new representation formalism is a system of many-sorted predicate logic. This is made explicit in both the syntax and the model theory for the new formalism which are given below. It is well-known that the transition from ordinary (1-sorted) predicate logic to many-sorted predicate logic is of little importance for metamathematics. Many-sorted formalisms can be embedded within their 1-sorted counterparts by adding predicates for the different sorts and adding postulates which express the sortal restrictions on the arguments of the original predicates and functors. It follows from this that systems of many-sorted first order logic are axiomatisable just as standard first order logic is; and the many-sorted variants of first order logic inherit other nice properties from standard first order logic as well. From this perspective the present extension thus seems much less dramatic than the introduction of plural discourse referents in the previous section.

However, our extensive experience with questions concerning the structure of time has taught us to be cautious. From a semantic perspective the present formalism is not just some arbitrary many-sorted generalisation of first order logic. It is a many-sorted logic the sorts of which are subject to certain conceptual constraints. For instance, time is conceived as a linear order, and some will go further and see its conception as carrying a commitment to its being unbounded, dense or even continuous (in the technical sense of being closed under limits of infinite ascending or descending sequences of bounded intervals). For someone who takes some or more of the sorts of the many-sorted system to be subject to such ontological constraints valid inference should mean “valid given that these constraints are satisfied”. If this is the notion of “logical” validity we are after, the question whether a many-sorted system is axiomatisable can no longer be answered in a simple once-and-for-all manner. It now depends on the nature of the postulates which express the properties that are part of the ontological commitments. If these

postulates are second order, then it may well be that validity ceases to be amenable to a finitary proof-theoretical characterisation.³¹

The problems we are facing when we pass from the DRT formalism of Section 3.1 to a many-sorted formalism where some of the sorts are assumed to come with a special structure are thus not unlike those which we encounter when we extend first order logic with non-standard quantifiers. What metamathematical properties our many-sorted system will have depends on what properties we assume for the different sorts it represents, just as the logical properties of extensions by non-standard quantifiers depend on the particular assumptions that are made about the semantics of those quantifiers.

We will not pursue these metamathematical questions here. (For the extensive knowledge that has been gathered about the effect of assumptions about the structure of time on the metamathematical properties of temporal logics we refer to [Dov Gabbay and Reynolds1994] and [Dov Gabbay and Finger2000]. One of the general surprises within this domain has been no doubt that constraints on the structure of time which are irreducibly second order may nevertheless lead to notions of validity for temporal logics which are axiomatisable (or even decidable). (This is not always so, but it is true for a remarkably broad range of cases.) What metamathematical properties we get for the “first order part” of the formalism defined below (i.e. the part without plural discourse referents) on various assumptions about the structure of time is a question which to our knowledge has hardly been studied. We leave this as one of the many open problems of this section.

The DRS language we now proceed to define is to be regarded as a prototype. We have decided to include in it those symbols and expressions which make appearances in the DRSs that have been displayed in this section. A good deal more is needed for a representation language which is able to represent in a transparent and natural way all temporal information expressible by means of natural language devices. (We will discover the need for some additional notation in Section ??.)

Like the DRS language considered in Section 3.1 the vocabulary of the present one to define includes the following three categories of symbols.

- (i) a set Ref of discourse referents,
- (ii) a set Rel of predicates, and

³¹The addition of plural discourse referents to the first order DRT formalism may be seen as a case in point. We could have introduced these as discourse referents of a new sort, whose values are sets (of cardinality ≥ 2 ; but this restriction has no importance in the present context). This would turn the representation system of the last section formally into a two-sorted system. That validity for this system cannot be axiomatised follows from the fact that the relationship between the values of the new discourse referents and those of the old ones – i.e. the relation that holds between sets and their members – is essentially second order. If we are content with less – e.g. by adopting one of the well-known first order set theories such as ZFU (Zermelo-Fränkel with Urelements), or GBU (Gödel-Bernays with Urelements) – as stating the relevant properties of and relations between the two sorts of individuals (viz. between Urelements and sets), then axiomatisability of validity is regained, albeit at the loss of the conceptually simplest way of conceiving of the realm of sets and its relation to the realm of things.

(iii) a set Name of proper names.

In addition we allow for function symbols. In the language presented here this category plays only a marginal role. It contains only one element, viz. the functor DAY-OF which was used in the representation of *yesterday* in (92). However, in a full-blown DRS formalism for the representation of temporal information many more functors are needed. The same is true for the category of 1-place predicates of times. Many of these are calendar predicates – predicates such as *day*, *week*, *year* – which are true of a time iff it is a member of the various partitions of the time line into successive intervals which the calendar imposes on it. We have found use for one such predicate here, viz. DAY; but obviously that is one of a whole “network” of calendar concepts. (For more on the modeltheoretic semantics of calendar-predicates and other predicates which involve the metric of time, see [Kamp and Schiehlen2002].) Finally, we will make use of a 1-place predicate EXISTS in order to be able to represent contingency of existence.

As noted, the principal difference between the present DRS language and those introduced earlier is that the new one is many-sorted. This is reflected in the structure of the set Ref given in Definition 0.34.

DEFINITION 0.34. Ref is the union of the following four mutually disjoint sets of

	Ind = $\{x_1, \dots, x_n, \dots\}$, a set of individual referents
discourse referents.	Time = $\{t_1, \dots, t_n, \dots\}$, a set of referents for times
	Event = $\{e_1, \dots, e_n, \dots\}$, a set of referents for events
	State = $\{s_1, \dots, s_n, \dots\}$, a set of referents for states

We refer to the sets Ind, Time, Event and State as “sorts”. We will later use the term “sort” also to refer to sets of entities in our models. No confusion should arise from this “overloading”.

DEFINITION 0.35. The set Rel of relation symbols consists of

- (i) n -place predicates of individuals;
- (ii) $(n + 1)$ -place predicates (with $n \geq 0$) where the first argument is an event and the remaining n arguments are of type individual (so-called $(n + 1)$ -place event predicates);
- (iii) $(n + 1)$ -place predicates (with $n \geq 0$) where the first argument is of type state and the remaining n arguments are of type individual (so-called $(n + 1)$ -place state predicates);
- (iv) 2-place predicate symbols denoting temporal relations between times, events and states: \prec , \subseteq , \supseteq ;
- (v) A 2-place predicate PROG, whose first argument is a state and whose second argument is a property of events;
- (vi) A 1-place predicate of times: DAY;
- (vii) A 1-place partial function of times: DAY-OF;
- (viii) A 1-place predicate of individuals, events and states: EXISTS;
- (ix) A 1-place functor from eventualities to times: DUR;

As before, DRS-conditions and DRSs are defined by simultaneous recursion. In Definition 0.36 we only specify the new clauses of the definition; they should be seen as supplementary to those of Definition 0.2. ((ix) replaces the earlier clause 0.2.ii for conditions of the form “ $x_i = x_j$ ”.)

DEFINITION 0.36. DRS conditions:

- (i) if $\tau, \sigma \in \text{Event} \cup \text{State} \cup \text{Time}$, R one of the predicates \prec , \subseteq and \supseteq , then $\tau R \sigma$ is a condition;
- (ii) if $e \in \text{Event}$, $x_1, \dots, x_n \in \text{Ind}$ and $R \in \text{Rel}$ an $(n + 1)$ -place event predicate, then $e:R(x_1, \dots, x_n)$ is a condition;
- (iii) if $s \in \text{State}$, $x_1, \dots, x_n \in \text{Ind}$ and $R \in \text{Rel}$ an $(n + 1)$ -place state predicate, then $s:R(x_1, \dots, x_n)$ is a condition;
- (iv) if $s \in \text{State}$, $e \in \text{Event}$, K a DRS and $e \in U_K$, then $s:\text{PROG}(\wedge e.K)$ is a condition;
- (v) if $s \in \text{State}$, $t \in \text{Time}$, K_1 and K_2 are DRSs and $t \in U_{K_1}$, then

$s:K_1 \left\langle \begin{array}{c} \forall \\ t \end{array} \right\rangle K_2$ is a condition;

- (vi) if $t \in \text{Time}$, then $\text{DAY}(t)$ is a condition;
- (vii) if $t_1, t_2 \in \text{Time}$, then $t_1 = \text{DAY-OF}(t_2)$ is a condition;
- (viii) if $\tau \in \text{Event} \cup \text{State} \cup \text{Ind}$, then $\text{EXISTS}(\tau)$ is a condition.
- (ix) if τ and σ are discourse referents of the same sort, then $\tau = \sigma$ is a condition.

The model theory for the DRS language defined above raises a number of fundamental questions. Some of these concern status and structure of the ontological categories of times, events and states, the relations between them and the relations between them and the category of (atomic and non-atomic) individuals which have been the sole denizens of the models considered up until this point. Secondly, there is the problem of contingent existence, which was mentioned briefly in Section 3.2 in connection with intensional models. In fact, in the present context this problem arises twice over, once in connection with possible worlds – what exists need not have existed necessarily – and once in connection with time – what exists at one time need not exist at every other time. Finally, models which involve both worlds and times raise the question how worlds and times are connected. An important part of our conception of possibility and necessity has to do with future contingency: our actual world can develop into one future or another, so what is one world at one time may turn onto one of a number of different possible worlds at a later time.

We begin with the problems which concern the ontological status of times and eventualities, their structural properties and the relations between them and individuals. The first question that an ontologist is likely to ask about these or any of the categories is in what sense, if any, entities belonging to them “exist”, or are “real”. Here the question is a fairly ramified one, since (apart from the cate-

gory of individuals of which we will assume for simplicity's sake that the question has already been answered) we are dealing with three categories at once – times, events and states. So a whole range of possible answers is possible in principle. One possible position is that only times constitute a primitive domain of “irreducible existents” and that events and states constitute “virtual” or “derived” entities which should be seen as constructs out of times (in combination, presumably, with entities from other sorts, such as individuals, properties or relations). But a diametrically opposed position, according to which events form an irreducible category and times are constructions out of events, has been put forward also (with or without the supplementary assumption that states are constructs defined from this basis as well). Yet another position is the one according to which events are to be analysed as transitions between states, and thus that the category of events is reducible to the category of states. (For discussion of some of these alternatives see [Benthem1983, Kamp and Reyle1993] and references there.)

This list is surely not exhaustive. But it suffices to show that the model theory for the DRS language we have specified in Definitions 0.34-0.36 might be grounded in a number of different ways, and that the philosophical logician is likely to prefer one version or another depending on his metaphysical persuasions. In the model theory we develop here we remain neutral on these issues of ontological priority and reducibility. Note, however, that we are committed to models in which all of the four mentioned sorts – individuals, times, events and states – are represented. For the vocabulary of our DRS language includes discourse referents of each of these sorts, and we want to stick to the general form of our semantic definitions, all of which are based on the notion of an assignment which maps discourse referents onto suitable entities in the model. In the context of this section (as in that of the last section) this entails that a discourse referent belonging to any one of these sorts should be always assigned entities of the model which are of its own sort. Under these constraints neutrality on matters of ontological reducibility can only mean this:

The universe of a model \mathcal{M} is composed of the four categories $\text{Time}_{\mathcal{M}}$, $\text{Event}_{\mathcal{M}}$, $\text{State}_{\mathcal{M}}$, $\text{Individual}_{\mathcal{M}}$. Whether any one of these categories can be reduced to any combination of the others is left open. Models which involve such reductions are not excluded. But they will be only some among the totality of all models admitted by the general definition we will give.

As far as the time structure of our models is concerned we want to be very specific. We are persuaded that people's intuitions about the structure of the time of the external world are, when pushed hard enough, to the effect that time is like the real numbers; so we will assume that the time structure $\mathcal{T}_{\mathcal{M}} = \langle T_{\mathcal{M}}, \prec_{\mathcal{M}} \rangle$ of \mathcal{M} is isomorphic to the reals. Our assumptions about the structure of events and states are less specific. The times of the model \mathcal{M} that are targets for assignments to the discourse referents in $\text{Time}_{\mathcal{M}}$ are not the “points of time” which make up the set $\mathcal{T}_{\mathcal{M}}$, but the “intervals” which can be formed out of these. The notion of

interval must be handled with some care, however, since the distinction between open and closed intervals of $\mathcal{T}_{\mathcal{M}}$ is meaningless from the perspective of natural language interpretation. We can eliminate the open-closed distinction either by forming equivalence classes of convex subsets of T – for two such sets X and Y we put $X \equiv Y$ iff $Cl(X) = Cl(Y)$, where $Cl(X)$, the “closure of X ”, is the set consisting of all limits of converging sequences of points in X – or, alternatively, by taking unique representatives of the equivalence classes of \equiv , for instance the intervals $(t_1, t_2]$ with $t_1 \prec_{\mathcal{M}} t_2$, together with $(-\infty, t_2]$, (t_1, ∞) and $(-\infty, \infty)$. These two options are not fully equivalent insofar as the first includes the points $t \in T_{\mathcal{M}}$ themselves – in the form of singleton equivalence classes $\{[t]_{\equiv}\}$ – whereas the second leaves them out. (There is no such half-open, half-closed interval as $(t, t]$.) In connection with the DRS language of Definitions 0.34-0.36 this difference appears to be of no importance but for definiteness’ sake we arbitrarily choose the second option. We refer to this set of intervals of \mathcal{T} as $\text{Time}(\mathcal{T}_{\mathcal{M}})$. (In connection with certain richer representation languages the question whether “intervals” consisting of single points should be included gains importance and must be considered carefully.)

We assume that each model \mathcal{M} has a set $E_{\mathcal{M}}$ of events and a set $S_{\mathcal{M}}$ of states, that these sets are disjoint and that together they form the set of eventualities $EV_{\mathcal{M}}$ of \mathcal{M} . $EV_{\mathcal{M}}$ is part of an eventuality structure $\langle EV_{\mathcal{M}}, \prec_{\mathcal{M}}, \circ_{\mathcal{M}} \rangle$, which is assumed to satisfy the following postulates.

DEFINITION 0.37. An *eventuality structure* $\mathcal{EV}_{\mathcal{M}}$ is a triple $\langle EV_{\mathcal{M}}, \prec_{\mathcal{M}}, \circ_{\mathcal{M}} \rangle$ with $EV_{\mathcal{M}} = E_{\mathcal{M}} \cup S_{\mathcal{M}}$ where $E_{\mathcal{M}}$ is a set of events and $S_{\mathcal{M}}$ a set of states. $\mathcal{EV}_{\mathcal{M}}$ satisfies for all eventualities $ev, ev_1, \dots, ev_4 \in EV_{\mathcal{M}}$:

- (1) $(ev_1 \prec_{\mathcal{M}} ev_2) \rightarrow \neg(ev_2 \prec_{\mathcal{M}} ev_1)$
- (2) $(ev_1 \prec_{\mathcal{M}} ev_2 \wedge ev_2 \prec_{\mathcal{M}} ev_3) \rightarrow (ev_1 \prec_{\mathcal{M}} ev_3)$
- (3) $ev \circ_{\mathcal{M}} ev$
- (4) $(ev_1 \circ_{\mathcal{M}} ev_2) \rightarrow (ev_2 \circ_{\mathcal{M}} ev_1)$
- (5) $(ev_1 \prec_{\mathcal{M}} ev_2) \rightarrow \neg(ev_2 \circ_{\mathcal{M}} ev_1)$
- (6) $(ev_1 \prec_{\mathcal{M}} ev_2 \wedge ev_2 \circ_{\mathcal{M}} ev_3 \wedge ev_3 \prec_{\mathcal{M}} ev_4) \rightarrow (ev_1 \prec_{\mathcal{M}} ev_4)$
- (7) $ev_1 \prec_{\mathcal{M}} ev_2 \vee ev_1 \circ_{\mathcal{M}} ev_2 \vee ev_2 \prec_{\mathcal{M}} ev_1$

$\mathcal{EV}_{\mathcal{M}}$ and $\mathcal{T}_{\mathcal{M}}$ are correlated via a function $\text{LOC}_{\mathcal{M}}$ which maps the eventualities in $EV_{\mathcal{M}}$ onto intervals of $\mathcal{T}_{\mathcal{M}}$, thereby locating these eventualities on the time axis defined by $\mathcal{T}_{\mathcal{M}}$. Thus $\text{LOC}_{\mathcal{M}}$ is assumed to assign each $ev \in EV_{\mathcal{M}}$ an interval in $\text{Time}(\mathcal{T}_{\mathcal{M}})$. We assume that $\text{LOC}_{\mathcal{M}}$ preserves the temporal relations of $\mathcal{EV}_{\mathcal{M}}$, that is: if $ev_1, ev_2 \in EV_{\mathcal{M}}$, then

- if $ev_1 \circ_{\mathcal{M}} ev_2$, then $\text{LOC}_{\mathcal{M}}(ev_1) \cap \text{LOC}_{\mathcal{M}}(ev_2) \in \text{Time}(\mathcal{T}_{\mathcal{M}})$,
- if $ev_1 \prec_{\mathcal{M}} ev_2$, then $\text{LOC}_{\mathcal{M}}(ev_1) \prec_{int} \text{LOC}_{\mathcal{M}}(ev_2)$
(where \prec_{int} is the relation which holds between two intervals $(t_1, t_2]$ and $(t'_1, t'_2]$ in $\text{Time}_{\mathcal{M}}$ iff $t_2 \prec_{\mathcal{M}} t'_1$).³²

³²It is well known that structures \mathcal{EV} satisfying the conditions of Definition 0.37 give rise to an

So far we have identified as components of our models:

1. A time structure $\mathcal{T}_{\mathcal{M}}$
2. An eventuality structure $\mathcal{EV}_{\mathcal{M}}$
3. An embedding $\text{LOC}_{\mathcal{M}}$ of the latter in the former

What we need in addition are:

4. A universe $U_{\mathcal{M}}$ of individuals
5. Interpretations for the predicates of the DRS language (specified in Definition 0.35)

Among the predicates there are three structural “predicates”, viz \prec , \subseteq and \supseteq , whose interpretation is determined by the information provided in 1-3 above. For instance, the interpretation $\mathfrak{S}_{\mathcal{M}}(\prec)$ is defined as follows:

DEFINITION 0.38.

(a) Let $\alpha \in \text{Time}(\mathcal{T}_{\mathcal{M}}) \cup \text{EV}_{\mathcal{M}}$, then

$$\text{Time}(\alpha) = \begin{cases} \alpha, & \text{if } \alpha \in \text{Time}(\mathcal{T}_{\mathcal{M}}) \\ \text{LOC}_{\mathcal{M}}(\alpha), & \text{if } \alpha \in \text{EV}_{\mathcal{M}} \end{cases}$$

(b) $\mathfrak{S}_{\mathcal{M}}(\prec) = \{ \langle \text{Time}(\alpha), \text{Time}(\beta) \rangle \mid \alpha, \beta \in \text{Time}(\mathcal{T}_{\mathcal{M}}) \cup \text{EV}_{\mathcal{M}} \wedge \text{Time}(\alpha) \prec_{\text{int}} \text{Time}(\beta) \}$

(c) The definitions of $\mathfrak{S}_{\mathcal{M}}(\subseteq)$ and $\mathfrak{S}_{\mathcal{M}}(\supseteq)$ are left to the reader.

instant structure $\mathcal{I}(\mathcal{EV}) = \langle I(\mathcal{EV}), \prec(\mathcal{EV}) \rangle$, where

- $I(\mathcal{EV})$ consists of all maximal sets of pairwise overlapping members of \mathcal{EV} (i.e. $i \in I(\mathcal{EV})$ iff (i) $i \subseteq \text{EV}$, (ii) whenever $ev_1, ev_2 \in i$, then $ev_1 \circ ev_2$, and (iii) if $i \subseteq H \subseteq \text{EV}$ and H has the property that $ev_1 \circ ev_2$ whenever $ev_1, ev_2 \in H$, then $H \subseteq i$).

And

- for $i_1, i_2 \in I(\mathcal{EV})$, $i_1 \prec_i i_2$ iff there are $ev_1 \in i_1$ and $ev_2 \in i_2$ such that $ev_1 \prec ev_2$.

On the basis of these definitions it is easy to show that $\mathcal{I}(\mathcal{EV})$ is a linear order, that for each $ev \in \text{EV}$ the set of $i \in I(\mathcal{EV})$ such that $ev \in i$ forms a convex subset of $I(\mathcal{EV})$, and that the relation “ $ev \in i$ ” is naturally interpreted as saying the i is a period of time at which ev is going on.

We might expect that the function $\text{LOC}_{\mathcal{M}}$ induces an order preserving embedding LOC' of $\mathcal{I}(\mathcal{EV})$ into the interval structure $\mathcal{INT}(\mathcal{T}_{\mathcal{M}})$ of $\mathcal{T}_{\mathcal{M}}$ via the condition

- (i) $\text{LOC}'(i)$ is that non-empty interval $(t_1, t_2]$ such that $(t_1, t_2] = \text{Cl}(\bigcap \{ \text{LOC}_{\mathcal{M}}(ev) \mid ev \in i \})$, where for arbitrary $X \subseteq T$ $\text{Cl}(X)$ denotes the convex hull of X in T .

However, in general this need not be so. On the other hand, if LOC' is such an embedding then LOC can conversely be defined in terms of it via

- (ii) $\text{LOC}_{\mathcal{M}}(ev) = (t_1, t_2]$, where $(t_1, t_2] = \text{Cl}(\cup \{ \text{LOC}'(i) : ev \in i \})$

More generally, when LOC' is any order preserving map from $\mathcal{I}(\mathcal{EV}_{\mathcal{M}})$ into $\mathcal{T}_{\mathcal{M}}$ and a function LOC on $\text{EV}_{\mathcal{M}}$ is defined from LOC' via (*), then LOC is order preserving.

We conclude that in some models \mathcal{M} $\text{LOC}_{\mathcal{M}}$ will be derivable from an underlying map LOC' , but not in all.

The extension of the predicate DAY in \mathcal{M} should partition $T_{\mathcal{M}}$ into a set of intervals which is order-isomorphic to some subset of the integers (some subset of the integers rather than all of the integers, since we want to allow for the possibility that there is a first and/or a last day).

Once the interpretation $\mathfrak{S}_{\mathcal{M}}(\text{DAY})$ is given, this also fixes the interpretation of the partial functor DAY-OF: If t is an interval belonging to $\text{Int}(T_{\mathcal{M}})$ and there is a member d of $\mathfrak{S}_{\mathcal{M}}(\text{DAY})$ such that $t \subseteq d$, then DAY-OF(t) is d . Otherwise DAY-OF is undefined.

We will not impose any constraints on the other predicates of Definition 0.35 (except for the predicates PROG and EXISTS, to which we will come below). In order to obtain a “realistic” class of models many further constraints would be desirable. However, formulating such constraints is a notoriously difficult problem. We return to the question in Section ??.

The second problem about which something needs to be said is that of contingent existence. In relation to the models that are needed here this problem arises “twice over”, we noted, once in connection with time and once in connection with modality. From a general logical point of view the problem is the same in either case; it constitutes one part of what in the classical analytical literature on modality is known as the problem of “quantifying in” (See among others: [Quine1961, Quine1956, Kaplan1969]). In DRT-terminology the problem can be described as follows. (We give the description for the case of worlds, but the version for times is analogous.) Suppose that in the process of evaluating a DRS K or a DRS condition γ in a given world w we assign to a given discourse referent x an entity d which exists in w , and suppose that the structure of K or γ requires that we evaluate parts of it which contain free occurrences of x at some other world in which d does not exist. In this case the evaluation will abort, and it is quite possible that it will abort for what is intuitively the wrong reason. A truth definition which does not handle this problem with the care it requires is likely to create a lot of truth value gaps in places where there shouldn’t be any.

Since the contingent existence problem arises as much in relation to time as in relation to possible worlds, the model theory for our present DRS language would have to deal with it even if it were kept purely extensional. But since what we want is an intensional model theory, we have to address both the temporal dimension of it and the possible world dimension. As a matter of fact we will not really deal with either dimension of the problem, but follow the avoidance strategy we adopted in Section 3.2: we blithely assume that everything that exists exists both necessarily and eternally. This formally avoids the quantifying-in problem we have described, but at the price of a notion of model that is blatantly unrealistic. However, in applications to the semantic analysis of natural language the conceptual disadvantages of this crude simplification can be minimised through the judicious use of existence predicates – predicates the extension of which at a given time in a given world consists of what exists at that time in that world. The extensions of such predicates will normally vary as a function of both worlds and times. By inserting

existence predicates into the semantic representations of sentences or discourses the most nefarious manifestations of the quantifying-in problem can usually be avoided. In formulating the satisfaction conditions for the DRS language under consideration we will encounter one problem for whose solution we will need an existence predicate. For this reason we add such a predicate to our language. We denote it as “EXISTS”. The contingency of existence which EXISTS allows us to represent is limited: it accounts for variation between worlds, but not between times within the same world. (In order to account for variation between times as well within the present formalism an existence predicate would have to be a 2-place predicate with an additional argument for times. Since variation between times is not needed for the application alluded to, we have decided to make do with the simpler version of a 1-place predicate.)

As we have already made the decision to adopt a notion of model which sweeps the problem of contingent existence under the rug, further discussion of this problem may seem an unwanted luxury. However, we want to point at some of the more specific problems that will have to be dealt with by a model theory in which the contingency problem is taken seriously. In particular we want to draw attention to the fact that behind the superficial similarity we have noted between the temporal and the modal dimension of the problem hide what seem to be important differences. One is that in the case of time an important role is played by temporal order: once something has existed, it continues to be something that can be referred to (for instance in order to assert of it that it exists no longer); but it is dubious whether something can be an object of reference at a time before it comes into existence. This contrast seems to be particularly pronounced for eventualities: for an event or state there is the time at which it happens or holds. But it is entirely natural to refer to it at later times as something that did occur or hold at the earlier time. (In fact, in almost all cases where we have made use of eventuality discourse referents in the DRSs above the discourse referents play just this role: they serve to represent events or states of which the DRS claims that they occurred at some time distinct from the utterance time.)

A special case for the question of contingent existence are the times themselves. Were we to assume that times “exist only at themselves”, and could not be referred to at any other time, then meaningful talk about time and times would be impossible. If we are to acknowledge time as an ontological category at all, then only as one whose elements are possible subjects of discussion at all times. In other words, times must – paradoxical as that may sound – be eternal if they are to be anything at all.

This doesn’t settle the modal dimension of the existence of time. We may still ask: is the time structure of one possible world the same as that of another, or could they be different? This is a question which is closely connected with the problem of ontological priority we mentioned earlier. Someone who sees time as an invariant receptacle within which the contingencies of the actual world unfold in the way they happen (whether this receptacle is to be seen as a metaphysical given in the sense of Newton or as a cognitively necessary condition on experience in the sense

of Kant) will be inclined to assume that time is the same in all possible worlds. Someone who sees time as an epiphenomenon generated by the actual course of events and whose structure is a reflection of the underlying event structure, would expect the structure of time to vary from world to world – like the underlying courses of events on which it depends.

In the light of these possibilities, our assumption that time is necessarily isomorphic to the reals reveals a definite *parti pris*. It is an assumption which reflects our conviction that what matters in a model-theoretic treatment of meaning in natural language is our conception of time, which informs the ways in which we think and speak. However, by itself the claim that time is necessarily isomorphic to the reals doesn't determine whether all worlds of a given model have the same time. Two worlds w_1 and w_2 could each have a time structure isomorphic to the reals and yet the set of times of w_1 might be disjoint from the set of times of w_2 . If that were so, there would be no natural way of comparing the times of w_1 with those of w_2 – there would be no straightforward way of “synchronising” the two worlds. In particular there would be no way of determining which time in w_2 corresponds to a time t_u at which a certain utterance is made in w_1 . This is a situation that, in the light of what we need our model theory for, should be avoided. The simplest (and most radical) way to avoid it is to assume that all worlds of a given model \mathcal{M} have one and the same time structure $\mathcal{T}_{\mathcal{M}}$; and this is what we do. (In fact, we already made this decision, since it is entailed by the more general one according to which all four ontological categories are constant between the different worlds of a given model.)

The last of the problems we mentioned above has to do with future contingency. In the philosophical literature this problem has often been discussed under the heading of “historical necessity” – a proposition about the future is historically necessary at a given point in time t iff it is necessarily true in virtue of what has been the case up to t and is the case at t itself. A natural way of modelling the intuition that some of the things that will happen later will happen as a matter of historical necessity while others will happen contingently, is as follows: a given world w , as it has developed up to the time t , can go on after t in any one of a number of different ways; these different ways form a “bundle” of future continuations of w after t which between them cover all that is possible in the light of what is and has been the case in w at t . It is common to formalise this by means of a 3-place relation between two worlds w_1 and w_2 and a time t , a relation which holds between w_1, w_2 and t iff w_1 and w_2 are alternative possible continuations of what was still a single world at t .

necessity ! historical

This relation between worlds and times has proved indispensable to the semantic and logical analysis of a significant range of natural language expressions and constructions. (And the same is true for a number of aspects of the interactive structure of worlds and times). Should one want to use the model theory developed here in the analysis of any of these, then it will have to be refined by endowing its models with additional structure of the kind discussed (see [Thomason2002]). In connection with the DRS language we have defined here, however, the additional

structure wouldn't do any work. So it isn't mentioned in the definition of models below.

DEFINITION 0.39.

An (*intensional*) *model* \mathcal{M} for the DRS language specified in Definitions 0.34-0.36 is a tuple $\langle W, U, \mathcal{EV}, \mathcal{T}, \text{LOC}, \mathfrak{S} \rangle$, where W is a non-empty set of worlds, U a non-empty set of individuals, where \mathcal{EV} , \mathcal{T} and LOC are described as above, and \mathfrak{S} is a function which assigns to each non-logical constant of our DRS language an appropriate extension at each world $w \in W$ and is subject to the constraints expressed in Def. 0.38 and those mentioned in the three paragraphs following it.

We have already assumed that the universe of individuals U , the eventuality structure \mathcal{EV} and the time structure \mathcal{T} are the same for all worlds of \mathcal{M} . What about LOC ? Here we do want to allow for variation. The intuition is that the same eventuality could have happened earlier in one world than it did in another, or that it could have taken more or less time in the first world than in the second. We achieve this by allowing $\text{LOC}(ev)$ to be different intervals in different worlds. So we assume that LOC is not simply a function from \mathcal{EV} to $\text{Time}(\mathcal{T}_{\mathcal{M}})$, but that it maps the worlds of W to such functions.

With regard to the interpretation function \mathfrak{S} the question of variability arises as well. We assume that the interpretation of the following non-logical constants of our DRS language are rigid (i.e. that they do not vary).

- (i) the proper names of our language, i.e. the members of Name ,
- (ii) the relations \subseteq , \supseteq and \prec ,
- (iii) the predicate DAY and the functor DAY-OF .

In other words, for each such expression α from this list we stipulate that if w, w' are any two worlds from W , then $\mathfrak{S}(\alpha)(w) = \mathfrak{S}(\alpha)(w')$.

For Name the assumption of rigidity was already made in Section 3.2, for DAY it is a stipulation for which we take the motivation to be clear, and for \prec , \subseteq , \supseteq and (given the rigidity of DAY) DAY-OF it follows from the definitions given above.

For all other non-logical constants we assume that they are not rigid. For the predicates some or all of whose arguments are of the sort individual we take this to need no justification. Likewise for the predicate PROG . For the functor dur non-rigidity is a consequence of the non-rigidity of LOC together with the self-evident principle that dur should be interpreted as LOC – that is, for every $w \in W$ $\mathfrak{S}(\text{dur})(w)$ is the function which maps each $ev \in \mathcal{EV}$ onto $\text{LOC}(w)(ev)$. The non-rigidity of EXISTS is of course the very point of the presence of this predicate in our language.

It should be emphasised once more that non-rigidity of the sort allowed for in our models does not give us as much variation as one might want. In particular, it fails to account for the temporal variation of predicates which in natural language are expressed by means of nouns, adjectives and prepositions. Such natural language predicates typically vary their extensions over time (being *blond*, *under 65*

kg, or a *student* are properties which a person may have at one time without having them at all times.) The n -place predicates between individuals, which are intended as the formal representatives of such non-verbal natural language predicates do not capture this dimension of variation. One way to deal with this problem is to represent non-verbal n -place predicates of natural language by means of $(n + 1)$ -place state predicates where necessary and keeping the n -place predicates of Definition 0.36 only for those natural language predicates which are “eternal” in the sense that when an individual (or tuple of individuals) satisfies it at one time, it satisfies them at all times.

Most of what needs to be said towards the definition of truth and other semantic relations between expressions of our DRS language and models has been said already. The new DRS conditions are, with only a couple of exceptions, simple atomic conditions for which the satisfaction conditions they contain are determined directly by the interpretations assigned to the non-logical constants they contain. One example should be enough to establish the general pattern. We choose conditions of the form “ $e:R(x_1, \dots, x_n)$ ”. In Section 3.2 we showed various forms in which notions like satisfaction and truth can be defined. Here we focus on the first of these, according to which an assignment verifies a DRS condition in a model at a world: $g \models_{\mathcal{M}, w} \gamma$ (see Definition 0.19 of Section 3.2). On the basis of these satisfaction clauses we can then define all other semantic notions introduced in 3.2 along the lines given there.

In this format the satisfaction clause for a condition of the form $e:R(x_1, \dots, x_n)$ takes the following form:

Let \mathcal{M} be a model in the sense of Definition 0.39, $w \in W$ and g an assignment which maps e onto an element of EV and x_1, \dots, x_n onto elements of U . Then

$$(122) \quad g \models_{\mathcal{M}, w} e:R(x_1, \dots, x_n) \text{ iff } \langle g(e), g(x_1), \dots, g(x_n) \rangle \in \mathfrak{S}(R)(w)$$

Of the remaining DRS conditions listed in Definition 0.36 there are three which need special attention. The first and easiest of these are DRS conditions of the form “ $t = \text{DAY-OF}(t')$ ”. We defined $\mathfrak{S}(\text{DAY-OF})$ as a partial function from intervals of $\text{Time}(\mathcal{T})$ to intervals of $\text{Time}(\mathcal{T})$ which is defined only if the argument is included in a member of $\mathfrak{S}(\text{DAY})$. Partiality doesn’t lead to truth value gaps in this case, because of the fact that terms of the form “ $\text{DAY-OF}(t')$ ” only occur in the context of conditions of the form “ $t = \text{DAY-OF}(t')$ ”. The following obvious satisfaction condition makes this clear:

Assume that \mathcal{M}, w are as above and that g maps t and t' to members of $\text{Time}(\mathcal{T})$. Then

$$(123) \quad g \models_{\mathcal{M}, w} t = \text{DAY-OF}(t') \text{ iff } t \in \mathfrak{S}(\text{DAY}) \text{ and } t' \subseteq t.$$

The second clause that deserves attention is that for conditions of the form “ $s:\text{PROG}(\wedge e.K)$ ”. Actually the satisfaction conditions follow the pattern of (122):

$$(124) \quad g \models_{\mathcal{M}, w} s:\text{PROG}(\wedge e.K) \text{ iff } \langle g(s), \llbracket \wedge e.K \rrbracket_{\mathcal{M}} \rangle \in \mathfrak{S}(\text{PROG})(w)$$

We mention conditions of this form nevertheless because they contain – as the only ones among all the atomic conditions of our DRS language – terms which are not simply discourse referents. These terms are the property terms that occur as second arguments of PROG. The presence of these terms provides no real obstacles to our truth definition. But the fact that they don't is something which deserves explicit notice. For it is here that, for the first time, our choice of an intensional model theory for the present DRS language proves to be essential. In view of the developments in Section 3.2 the definition of satisfaction and truth of which (122) and (123) are constitutive clauses yields among other things a denotation for terms of the form $\wedge e.K$. For this reason we can assume the property $\llbracket \wedge e.K \rrbracket_{\mathcal{M}}$ to be defined at the point where it is needed in the definition of the satisfaction condition of “s:PROG($\wedge e.K$)”.

The last and most problematic type of DRS condition is that which uses duplex conditions to characterise states as quantificational states. We repeat the general form of such conditions in (125).

$$(125) \text{ s: } \boxed{\begin{array}{c} t \\ K_1 \\ t \subseteq \text{dur}(s) \end{array}} \diamond \begin{array}{c} \forall \\ t \end{array} \boxed{K_2}$$

(N.B. the box on the left should be seen as follows: it is a DRS K such that $t \in U_K$ and $t \subseteq \text{dur}(s) \in \text{Con}_K$.)

The problem with these conditions is that so far we have done no more than hint at what truth conditions they represent. We have described the quantificational state s as one that is to the effect that the quantification holds over the period of its duration. But what exactly does this mean and how could it be made precise? We propose the following: in order that s be a state to the effect that the given quantification holds over the period that it defines, the proposition that s exists must be the same as the proposition that the quantification holds over the given period. This leads for conditions of the form (125) to the satisfaction condition in (126). (It is at this point, and at this point only, that we have to make use of our existence predicate EXISTS in the satisfaction and truth definition of our DRS language.)

$$(126) g \models_{\mathcal{M}, w} \text{ s: } \boxed{\begin{array}{c} t \\ K_1 \\ t \subseteq \text{dur}(s) \end{array}} \diamond \begin{array}{c} \forall \\ t \end{array} \boxed{K_2} \text{ iff}$$

there is an interval $t_{fr} \in \text{Time}(\mathcal{T}_{\mathcal{M}})$ such that $t_{fr} = \llbracket \text{dur}(s) \rrbracket_{\mathcal{M}, g}$
and

$$(*) \llbracket \wedge \text{EXISTS}(s) \rrbracket_{\mathcal{M}, g} = \llbracket \boxed{\boxed{\begin{array}{c} t \\ K_1 \\ t \subseteq \text{dur}(s) \end{array}} \diamond \begin{array}{c} \forall \\ t \end{array} \boxed{K_2}} \rrbracket_{\mathcal{M}, g'}$$

where $g' = g \cup \{t', t_{fr}\}$.

N.B. In general there is no reason to assume that the condition (*) in (126) determines s uniquely. But the idea that s is exhaustively characterised by this condition is not all that far-fetched; and it would be possible to adopt the condition that this is so as a general constraint on models.

This completes the satisfaction definition in essence. The complete definition is obtained by combining (123), (124), (126) with (a) clauses for the other atomic conditions of Definition 0.36 for which (122) serves as example, and (b) the clauses of the Satisfaction Definition 0.19 of Section 3.2. As we already observed, all the other semantic relations mentioned in 3.2 can be defined for the extended languages too.

To conclude, a remark relating to the DRS conditions (iv) and (v) of Definition 0.36. We begin with the PROG-condition defined in (iv). We argued that the existence of an event which satisfies a DRS K is not a necessary condition for the existence of a state s such that $s:\text{PROG}(\wedge e.K)$. But intuitively the condition is sufficient and if it is to be that also formally, then there should be enough states around to make it so. In order to make sure of this we must impose on our models the requirement that they verify the following existence postulate.³³

$$(127) \quad \boxed{\begin{array}{c} e \text{ t} \\ K \\ t \subseteq e \end{array}} \Rightarrow \boxed{\begin{array}{c} s \\ t \subseteq s \\ s:\text{PROG}(\wedge e.K) \end{array}}$$

(Here we have followed the same convention as in (125): The box on the left hand side of \Rightarrow is a DRS K such that $e \in U_K$ and “ $t \subseteq e$ ” $\in \text{Con}_K$.)

The quantificational state conditions specified in Definition 0.36.v also cry out for a supporting existence postulate. In this postulate we make use of the same principle which we also used in defining the satisfaction condition of quantificational state conditions: if a temporal quantification condition holds over a period of time t_{fr} then there exists a state the duration of which is t_{fr} and which exists in any world w iff the quantificational state condition holds over t_{fr} in w .

³³It may be felt that this is not quite right in so far as the progressive state does not hold up to the very end of e . To formulate the meaning postulate in a way that takes account of this we would need a richer vocabulary for expressing temporal relations than the given DRS language provides. Another possible objection against (127) is that it is wrong for the progressives of so-called achievement verbs such as *die*. *He was dying* expresses a state which is usually seen as preceding the event of death itself, rather than as being included in it. To deal with this, (127) should either be replaced by a weaker disjunction which distinguishes between achievements and accomplishments, or else one would have to assume that the interpretation of sentences like *He was dying* involves as an intermediate step extending the predicate *die* to one which is true of events that the process that leads up to the actual death is an integral part of.

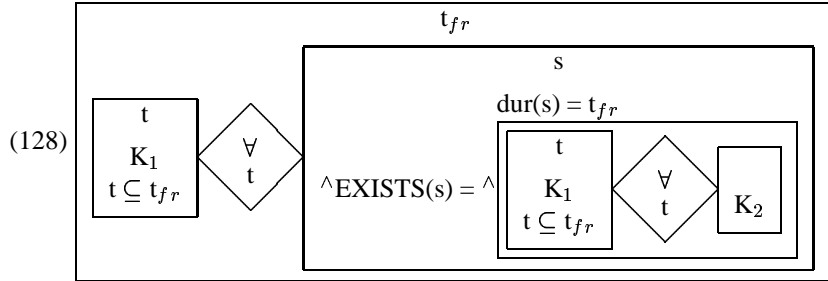

meaning postulate

(127) and (128) can be regarded as meaning postulates. Meaning postulates play the same role in the model theory of DRS languages as they do in Montague Grammar; they act as constraints on models which narrow the class of models down by eliminating models which violate the semantic adequacy conditions they express. In this regard (127) and (128) do not differ, of course, from the axioms on $\mathcal{E}\mathcal{V}$ given in Definition 0.37, the postulate that \mathcal{T} be isomorphic to the reals, or the conditions of Definition 0.31 in Section 3.4 which articulate the mereological structure of U . However, the bulk of meaning postulates that will be needed to arrive at a satisfactory model theory for a DRS language suitable for the representation of natural language have to do with the meanings of individual lexical items such as nouns and verbs. We will consider some examples of such postulates in Section ??.

The DRS language for which we defined syntax and model theory in this last part of Section 3.5 may have left a rather motley impression. This is the effect of our decision to include in our language only those special predicates and functors which happened to be needed in the DRSs displayed earlier in the section. As we noted, a DRS language capable of representing, in a direct and natural way, the temporal information expressible in a language like English would require a much richer vocabulary, and would appear much less arbitrary than the one we have considered here.

From a methodological point of view, however, the language we have presented is not as arbitrary as it may seem. For the predicates and functors it contains exemplify between them a substantial part of the complications a model theory for a DRT-based language capable of presenting the various kinds of temporal information we find in natural language will have to deal with. The largest simple exception to this concerns the substantial range of concepts which natural languages employ for the description of metric concepts. There is only one pale reflection of this aspect of time in the language we represent here, viz. the predicate DAY. Its extension, we said, partitions the time into intervals. Intuitively these intervals are all of equal duration. But since in the language considered here DAY is the only metric notion, the metric aspect of its extension played no further part. For some of the issues connected with the model theoretic treatment of metric-related expressions of English see [Kamp and Schiehlen2002].

3.6 A First-Order DRT Calculus

When we ask whether a given conclusion that is presented in natural language follows from premises given in that same language it will quite often be the case that the conclusion depends for its interpretation in various ways on those premises. To take an extremely simple example, is the following argument valid:

argument

- (129) Peter ate a pizza and drank a glass of wine.
So, he ate something.

Here the second sentence does seem to follow from the first. But it does so only when we interpret *he* as anaphoric to *Peter*.

A natural way to capture the context-dependent notion of validity illustrated by this example is to construct a DRS K_{pr} for the premises of the argument and to then use this DRS K_{pr} as context for the construction of a DRS K_{con} for the putative conclusion. What we will typically get in this way is a pair consisting of (i) a proper DRS K_{pr} and (ii) a possibly improper DRS, but such that the merge of K_{pr} and K_{con} is again proper. Of this pair we can then ask whether the first DRS semantically entails the second, that is if any verifying embedding f of K_{pr} in any model \mathcal{M} can be extended to a verifying embedding of K_{con} in \mathcal{M} . The following definition generalises this intuition. For technical reasons it allows for free discourse referents to occur in K_{pr} and K_{con} . Nevertheless K_{pr} and K_{con} must be *pure*, i.e. no discourse referent is allowed to be declared in two distinct DRSs, one subordinate to the other.

validity

DEFINITION 0.40. For K and K' *pure* (but not necessarily *proper*) DRSs: $K \models_{\text{DRS}} K'$ holds iff for every model $\mathcal{M} = \langle U, \mathfrak{F} \rangle$ and embedding functions f and g such that $f \subseteq_{U, K \cup FV(K) \cup FV(K')} g$ such that $\langle f, g \rangle \models_{\mathcal{M}} K$, there is a function h such that $g \subseteq_{U, K'} h$ such that $\langle g, h \rangle \models_{\mathcal{M}} K'$.

In order to obtain a proof system for this notion of validity wrt. the first order DRS language presented in Section 3.1, there are two options. The first consists in mapping a proof argument $K_{pr} \vdash K_{con}$ into the formula of predicate logic that is the result of the translation of the DRS-condition $K_{pr} \Rightarrow K_{con}$ according to Def. (0.12) above and then employ any of the standard calculi developed for FOPL (viz. [Sundholm1986],[Sundholm2001]). The second option is to develop deduction rules that operate directly on DRT style proof representations $K_{pr} \vdash K_{con}$. [Koons1988], [Sedogbo1988], [Reinhard1989], [Saurer1993], [Reyle and Gabbay1994] and [Kamp and Reyle1991] provide a number of sound and complete proof systems of this type, obviating the detour through FOPL. In the following we will present the calculus presented in [Kamp and Reyle1991].

[Kamp and Reyle1991] represent premise conclusion pairs K_{pr} and K_{con} in the format used in [?] and [?] with K_{con} occurring within a “Show-line” that is embedded within the premise DRS $K_{pr} = \langle \{x_1, \dots, x_n\}, \{\gamma_1, \dots, \gamma_m\} \rangle$:

Show-line

$$(130) \quad \boxed{\begin{array}{c} x_1 \dots x_n \\ \gamma_1 \\ \vdots \\ \gamma_m \\ \text{Show: } K_{con} \end{array}}$$

A proof is accomplished if the Show-line is cancelled, denoted by $\text{Show: } K_{con}$. Cancelling of a Show-line is achieved whenever one of the *rules of proof* has successfully been applied to it. Additional Show-lines may be added at any point in the derivation (provided only that merging the Show-line DRS with the DRS into which the Show-line is inserted would not result in an improper DRS). However, once a Show-line has been introduced it must be cancelled at a later time in order that the derivation counts as complete.

Rules of proof come in two types: *direct* and *indirect* rules of proof. Direct proofs do not involve any subproofs while indirect ones do. The system has one direct rule of proof RDP (Rule of Direct Proof) and two indirect rules of proof CP (Conditional Proof) and RAA (Reductio Ad Absurdum). In addition to the rules of proof there are *inference rules*. They apply to a DRS K_{pr} and extend it to a DRS K'_{pr} with $K_{pr} \subseteq K'_{pr}$. The system without disjunction and identity involves three inference rules DET (Detachment - also referred to as GMP (Generalized Modus Ponens)), DNE (Double Negation Elimination) and NEU (Non-Empty Universe). The full system with disjunction and identity features four additional inference rules MTP (Modus Tollendo Ponens), DI (Disjunction Introduction), SoI (Substitution of Identicals) and SI (Self-Identity). Soundness and completeness theorems relating \models_{DRS} and \vdash_{DRS} are proved in [Kamp and Reyle1991]. Moreover, the sublanguage involving “ \neg ” but without “ \Rightarrow ” and “ \vee ” requires only the rules of proof RDP and RAA and the inference rules DNE and NEU (as well as SOI and SI iff “ $=$ ” is included as well). In each of these cases the system consisting of the mentioned inference rule and rules of proof is sound and complete for the model theory of Section 3.1.

SUMMARY 0.41. Architecture of a First-Order DRT Calculus

Rules of Proof			
DIRECT		INDIRECT	
RDP	Rule of Direct Proof	CP	Conditional Proof
		RAA	Reductio Ad Absurdum

Inference Rules	
DET	Detachment
DNE	Double Negation Elimination
NEU	Non-Empty Universe
MTP	Modus Tollendo Ponens
DI	Disjunction Introduction
SOI	Substitution of Identicals
SI	Self Identity

The Rule of Direct Proof (RDP) states that a DRS or DRS-condition Δ is proved if an alphabetic variant Δ' of Δ occurs as part of the DRS which contains the Show-line Show: Δ . direct proof ! rule of RDP

There are two notions in this description which have not yet been defined, “alphabetic variant” and “contains”. The definition of “contains” is entirely straightforward.

DEFINITION 0.42. A DRS $\langle U_1, Con_1 \rangle$ is contained in a DRS $\langle U, Con \rangle$ iff $U_1 \subseteq U$ and $Con_1 \subseteq Con$. contains

The notion of alphabetic variant is most clearly defined for pure DRSs (see Definition 0.6). Since alphabetic variance enters into the formulation of several rules we will make things easy by restricting attention in this section to pure DRSs. (It can easily be verified that the changes produced by the application of the rules of the system preserve purity.)

DEFINITION 0.43. Let K and K' be DRSs. Then K' is an *alphabetic variant* of K iff there is a function f which maps the set $BV(K)$ of bound discourse referents of K onto the bound discourse referents of K' such that alphabetic variant

- (i) for each sub-DRS K'' of K $f|_{U_{K''}}$ is one-to-one, and
- (ii) K' is the result of replacing for each $x \in BV(K)$ all occurrences of x in K by $f(x)$.

For the remainder of this section all DRSs will be pure.

DEFINITION 0.44. **Rule of Direct Proof (RDP):** if a DRS K contains a Show-line Show: Δ and if K contains Δ' where Δ' is an alphabetic variant of Δ , the Show-line may be cancelled.

Direct Proofs are proofs involving RDP and the inference rules only. The inference rule of Detachment (DET - also referred to as Generalised Modus Ponens) applies to DRS conditions of the form $K_1 \Rightarrow K_2$ in a DRS K . DET states that provided it is possible to homomorphically embed the antecedent K_1 into K we can add to K an alphabetic variant K'_2 of the consequent K_2 such that direct proof
detachment
modus ponens ! generalised

- (i) the bound discourse referents of K'_2 do not already occur in K , and
- (ii) K'_2 extends the homomorphic embedding f of K_1 .

DEFINITION 0.45. Detachment (DET) (Generalized Modus Ponens (GMP)):
 Given a DRS K , if $K_1 \Rightarrow K_2 \in \text{Con}_K$ and if there is a homomorphic embedding $f(K_1)$ into K , then we may add an alphabetic variant $g(K_2)$ to K where $f \subseteq U_{K_2}$
 $g, g \setminus f$ is one-to-one and g maps U_{K_2} to a set of discourse referents that do not already occur in K .

Definitions (0.44) and (0.45) can be illustrated with the following example. In order to show that

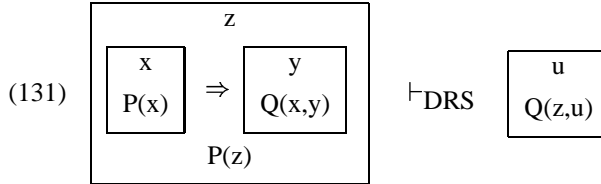

we add a Show-line with the conclusion to the premise in (131):

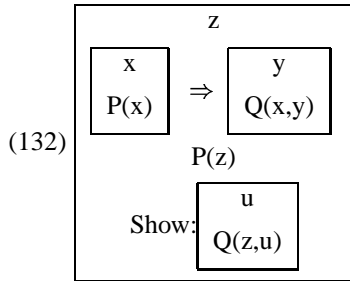

Since the left-hand-side of the conditional DRS condition in (132) can be homomorphically embedded in the main DRS we can apply DET (0.45) and add an alphabetic variant of the right-hand-side, which extends the homomorphic embedding of the left-hand side, to the main DRS as shown on the left of (133). Then we apply RDP and cancel the Show-line yielding the proof structure shown on the right of (133), completing the proof of (131):

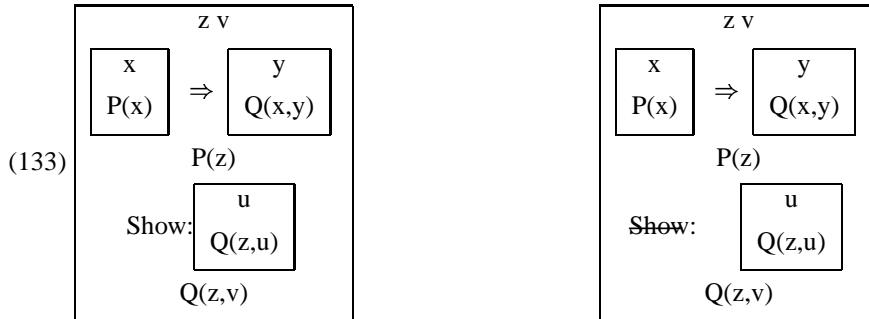

The rule of Double Negation Elimination (DNE) applies to structures of the form

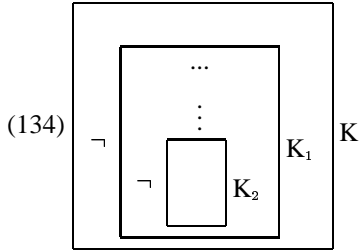

In simple cases this amounts to the cancellation of two negation signs. In more complex cases where K_1 contains conditions other than $\neg K_2$, DNE can be applied provided that $K_1 - \langle \emptyset, \{\neg K_2\} \rangle$ has a homomorphic embedding in K .

DEFINITION 0.46. Double Negation Elimination (DNE): if $\neg K_1 \in \text{Con}_K$ and $\neg K_2 \in \text{Con}_{K_1}$ and $f(K_1 - \langle \emptyset, \{\neg K_2\} \rangle)$ is a homomorphic embedding into K , then $g(K_2)$ may be added to K where $f \subseteq U_{K_2} g$, $g - f$ is one-to-one and g maps the set of discourse referents U_{K_2} to a set of discourse referents new to K .

The rule of Non-Empty Universe (NEU) states that we only consider models with non-empty universes. This means that we can always introduce discourse referents at the highest level of the DRS.

non-empty universe
NEU

DEFINITION 0.47. Non-Empty Universe (NEU): if K is a DRS we may always add a new discourse referent to U_K .

Disjunction is treated in terms of two inference rules: Modus Tollendo Ponens (MTP) and Disjunction Introduction (DI). Modus Tollendo Ponens states that given a DRS with a disjunctive condition together with the negation of an alphabetic variant of one of the disjuncts we may add a disjunctive condition to the DRS which is like the original disjunction except that the disjunct corresponding to the negated condition is missing.

modus tollendo ponens
MTP
disjunction introduction
DI

DEFINITION 0.48. Modus Tollendo Ponens (MTP): given an DRS K with a disjunctive condition of the form $K_1 \vee \dots \vee K_{i-1} \vee K_i \vee K_{i+1} \vee \dots \vee K_n$ and a condition of the form $\neg K'_i$ where K'_i is an alphabetic variant of K_i we may add $K_1 \vee \dots \vee K_{i-1} \vee K_{i+1} \vee \dots \vee K_n$ to K .

Disjunction Introduction permits us to introduce any disjunctive condition into a DRS if the DRS already contains one of the disjuncts.

DEFINITION 0.49. Disjunction Introduction (DI): if K_i is included in K then we may add $K_1 \vee \dots \vee K_{i-1} \vee K_i \vee K_{i+1} \vee \dots \vee K_n$ to K .

The proof system features two inference rules pertaining to identity: Substitution of Identicals (SoI) and Self-Identity (SI).

substitution of identicals
SoI
self-identity
SI

DEFINITION 0.50. Substitution of Identicals (SoI): if K contains conditions $x = y$ and γ where $x, y \notin \text{Decl}(\gamma)$, we may add a condition γ' to K where γ' results from γ by replacing one occurrence of x by y .

DEFINITION 0.51. **Self-Identity (SI):** if K is a DRS, then for any $x \in U_K$ we may add $x = x$ to K .

As stated the inference rules apply at the level of the “main” DRS only. It can be shown, however, that the application of the inference rules can be *extended* to embedded DRSs and furthermore that every argument provable in the thus *extended proof system* is also provable in the old system.

The inference rules described above are based entirely on the premise DRS. Applying them extends the premise DRS until RDP can be applied. Proofs based on RDP and the inference rules are referred to as *direct* proofs. They do not involve any intermediate proofs and do not introduce any new temporary assumptions. In addition to direct proofs, the calculus features two rules of proof for *indirect* proofs involving sub-proofs and the introduction of temporary assumptions. These rules are the rule of Conditional Proof (CP) and Reductio ad Absurdum (RAA).

The rule of Conditional Proof is applied in proofs of DRS conditions of the form $K_1 \Rightarrow K_2$ in a premise DRS K . CP introduces a sub-proof which, on the assumption that an alphabetic variant of K_1 holds, tries to derive a variant of K_2 . The sub-proof may make use of what is asserted in the premise DRS K . If the sub-proof is successful, $K_1 \Rightarrow K_2$ is established and the sub-proof and the temporary assumption are discarded.

DEFINITION 0.52. **Conditional Proof (CP):** if Con_K in a premise DRS K contains a Show-line $\text{Show: } K_1 \Rightarrow K_2$, we may introduce a sub-proof



where K'_1 and K'_2 are alphabetic variants of K_1 and K_2 , respectively. When the Show-line in the sub-proof is cancelled, the Show-line $\text{Show: } K_1 \Rightarrow K_2$ in the premise DRS K may be cancelled as well.

Suppose we want to show

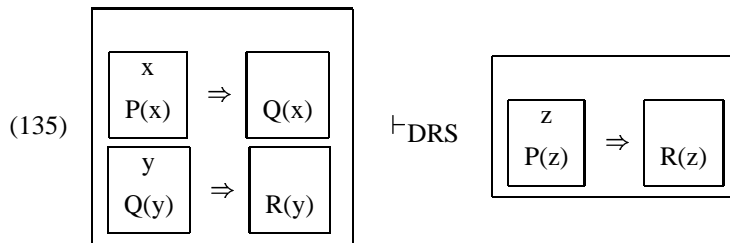

We add the conclusion in a Show-line to the premise DRS and apply CP.

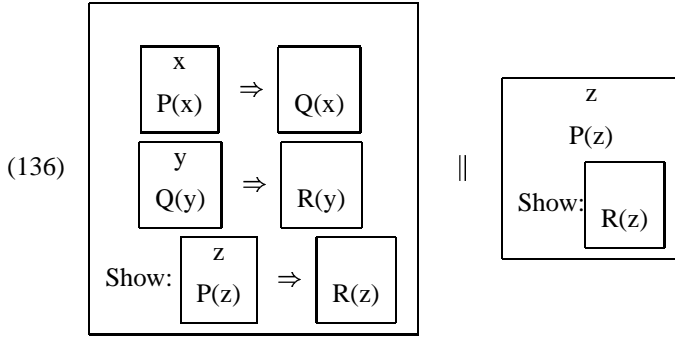

Note well: In connection with proving the Show-line to the right of || the entire DRS to the left of || is available as premise (with the exception of course of the Show-line, or Show-lines it contains). Put differently, the premise DRS for the Show-line on the right is the merge of the DRSs to the left and right of || without their respective Show-lines. In this regard the architecture of the present system is like that of any other natural deduction system.

Now we can apply DET twice: from $\langle \{z\}, \{P(z)\} \rangle$ in the CP sub-derivation and the first condition in the premise DRS we get $Q(z)$ and from $\langle \{z\}, \{Q(z)\} \rangle$ together with the second condition in the premise DRS we get $R(z)$.

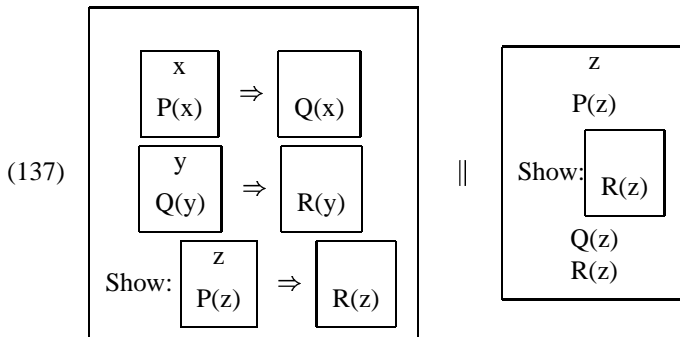

Now RDP may be applied to the CP sub-derivation cancelling the Show-line Show:

$R(z)$. According to the CP rule we may also cancel the Show-line in the premise DRS, completing the proof of (135).

The final rule of proof, Reductio ad Absurdum, also opens up a new sub-derivation in which we try to show that the assumption $\neg K'_1$ where K'_1 is an alphabetic variant of K_1 and K_1 is a goal in a Show-line in the premise DRS, leads to an explicit contradiction thus establishing K_1 . Here by an explicit contradiction we mean the following. A DRS K contains an explicit contradiction iff there is a DRS K' such that

reductio ad absurdum

- (i) $\neg K'_1 \in \text{Con}_K$, and

(ii) K contains an alphabetic variant of K' .

We use \perp to represent arbitrary contradictions of this kind. Thus “Show: \perp ” can be cancelled when the DRS containing this Show-line also contains such a combination of $\neg K'$ and a variant of K' (for any K' whatever).

DEFINITION 0.53. **Reductio ad Absurdum (RAA)**: if Con_K of some premise DRS K contains a Show-line Show: K_1 we may introduce a sub-proof

$$K \quad || \quad \boxed{\begin{array}{l} \neg K'_1 \\ \text{Show: } \perp \end{array}}$$

When the Show-line in the sub-proof is cancelled, the Show-line “Show: K_1 ” in the premise DRS K may be cancelled as well.

One place where RAA is needed is in the proof of the principle of Modus Tollens, which in the present system is a derived rather than a primitive rule. The following example shows one variant of this principle.

Modus Tollens

$$(138) \quad \boxed{\begin{array}{l} \boxed{\begin{array}{l} x \ y \\ P(x,y) \end{array}} \Rightarrow \boxed{\begin{array}{l} u \\ Q(u,x) \end{array}} \\ \neg \boxed{\begin{array}{l} v \ t \\ Q(v,t) \end{array}} \end{array}} \quad \vdash_{\text{DRS}} \quad \boxed{\begin{array}{l} \neg \boxed{\begin{array}{l} x \ y \\ P(x,y) \end{array}} \end{array}}$$

We add the conclusion in a Show-line and apply RAA and DNE.

$$(139) \quad \boxed{\begin{array}{l} \text{(i)} \quad \boxed{\begin{array}{l} x \ y \\ P(x,y) \end{array}} \Rightarrow \boxed{\begin{array}{l} u \\ Q(u,x) \end{array}} \\ \text{(ii)} \quad \neg \boxed{\begin{array}{l} v \ t \\ Q(v,t) \end{array}} \\ \text{Show: } \neg \boxed{\begin{array}{l} w \ z \\ P(w,z) \end{array}} \end{array}} \quad || \quad \boxed{\begin{array}{l} w' \ z' \\ P(w',z') \\ \text{Show: } \perp \end{array}}$$

By applying DET on (i) and the DRS on the right of $||$ we obtain:

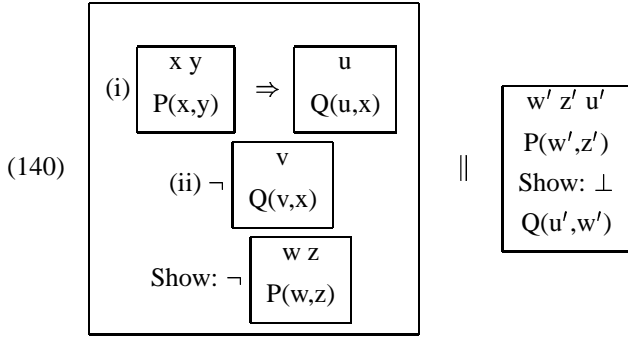

We now have \neg $\begin{matrix} v t \\ Q(v,t) \end{matrix}$ as a condition in the DRS to the left of \parallel and a variant

$\begin{matrix} u' w' \\ Q(u',w') \end{matrix}$ of the DRS in the scope of the negation contained in the (extended) DRS to the right of \parallel . This establishes the contradiction and we can cancel the Show-line “Show: \perp ” on the right and with it the Show-line in the DRS on the left, completing the proof.

Note also that the DRS version of the argument $\neg(A \wedge \neg B), A \vdash B$ (a version of Modus Ponens) can be proved by a simple application of RAA. For example, the Show-line in (141.a) can be derived by adding the environment for an application of RAA to the right of it as shown in (141.b).

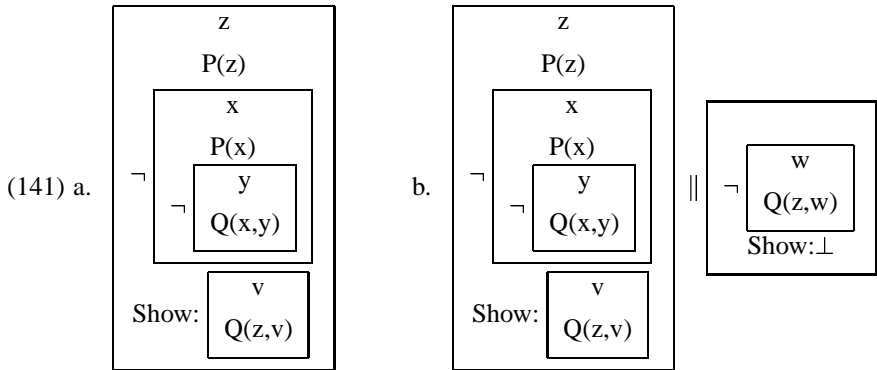

It now suffices to observe that if we add the new assumption \neg $\begin{matrix} y \\ Q(z,y) \end{matrix}$ to the DRS on the left, then this DRS will contain an alphabetic variant of the condition

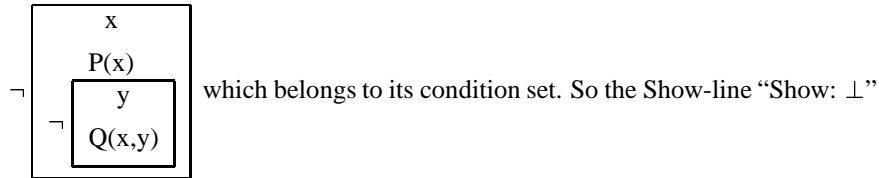

can be cancelled and with it the Show-line on the left.

We noted earlier that the fragment of the DRS language of Section 3.1 in which only complex conditions are of the form $\neg K$ has the same expressive power as the full language. For this sublanguage the present system reduces to one consisting of the rules RDP, NEU, DNE and RAA. This system is sound and complete for the given fragment, just as the full system is sound and complete for the full language of Section 3.1.

One of the features of DRS languages, we stressed in Section 3.3, is that they do not separate sentential and quantificational aspects in the manner familiar from standard predicate logic. This feature of the syntax of DRS languages has its reflection in the rules of the deduction system we have presented. It is manifest in every rule which involves matching of alphabetic variants. This feature we have seen, is particularly prominent in applications of DET and RAA, and indeed it is only because RAA is stated as applicable in cases of a contradiction between alphabetic variants that DNE, NEU, RDP and RAA suffice for the fragment which is without “ \Rightarrow ”, “ \vee ” and “ $=$ ”. But it is indispensable also in the presence of other rules such as DET and CP. Without this flexibility in the application of RAA the DR-theoretical equivalent of $\neg(A \wedge \neg B), A \vdash B$ cannot be derived even when all the other rules are available. In short, matching of alphabetic variants in the application of deduction rules is the proof theoretic mirror of the structural binding of discourse referents (through membership in a certain DRS-universe) which is perhaps the most distinctive feature of the DR-theoretical representation format.

Given that the present deduction system clearly reflects this feature of the DRS language to which the system applies, it would appear to be of interest (i) to extend it with rules that equally mirror this feature of DRT for the extended languages we have discussed in Sections 3.3–3.5 (Of course for the non-axiomatisable extensions, such as that of 3.4, such a coverage could only be partial.); and (ii) to explore the possibilities of implementations of such proof procedures. To our knowledge neither of these tasks has thus far been pursued in good depth.

4 PRESUPPOSITION

4.1 Introduction

Dynamic Semantics is ideally suited to the analysis of presupposition. This is true of all versions of it, including the two that come first historically, File Change Semantics (FCS, see [Heim1982]) and DRT. As we have seen in the previous sections for DRT, a central rationale for these theories was to give a context-based account of pronominal anaphora. In this section we will see how such an account can be extended to a context-based account of presupposition.

presupposition

File Change Semantics

To deal with cases of transsentential anaphora one needs a formally precise notion of context. All Dynamic theories provide such a notion, a notion of “discourse” context which evolves as the discourse proceeds, with each new sentence meaning its own contribution to it. Each sentence is to be interpreted in the current discourse context, and thus in the light of what its predecessors have contributed to it. The notion of discourse context can be refined, moreover, so that it can change even in the course of a single sentence, with some parts of the sentence contributing to the context serving the interpretation of some part. We already saw that along these lines it is possible to develop a uniform account of transsentential and sentence-internal anaphora.

context

The Dynamic concept of a discourse context which changes not only between sentences but also sentence-internally is crucial not only for an account of anaphora but also of presupposition. In particular it is essential for dealing with the so-called Projection Problem. Sometimes a presupposition that is generated within some part of a logically complex sentence is perceived as presupposition of the entire sentence – the presupposition “projects” – and sometimes it seems to have disappeared when one considers the sentence as a whole – the presupposition does not “project”. The basic strategy that the Dynamic approach offers for explaining this difference is surprisingly simple: A presupposition doesn’t project if it is justified by its “local” context, i.e. on the basis of contextual information that is entirely sentence-internal. For in that case its justification has no further need for information from the “global”, or sentence-external, context; so, as far as this presupposition is concerned any global context whatever would be a suitable context in which the sentence could, as far as presuppositions are concerned, be properly used.

Projection Problem

context ! local

context ! global

The parallel that is suggested by this gloss on presupposition projection is too obvious to overlook: When a pronoun has a sentence-internal antecedent – i.e. when it finds an antecedent in its local context – it is no obstacle to interpreting the sentence as one which expresses a proposition on its own, and no further contextual information is required. Likewise for a locally justified presupposition. Only when pronoun or presupposition cannot be accounted for on the basis of sentence-internal information alone does their presence turn into a constraint on the global context – to provide an antecedent for the pronoun or to justify (or assist in justifying) the presupposition.

Indeed, it was not long after FCS and DRT were first proposed that Heim formulated an account of presupposition which extends the Dynamic approach to anaphora to presuppositional phenomena, and most notably to the Projection Problem ([Heim1983]). But it wasn't until the very end of the eighties that the central ideas of her proposal were pushed further. At that point a number of people proposed an even more tightly unified account of presupposition and anaphora. (See [Geurts and van der Sandt], [van der Sandt1992], [Zeevat1992]). In these proposals anaphoric expressions (and especially pronouns) are treated as "presupposition triggers", on a par with the presupposition triggers which in the theory of presupposition had long been recognised as such: definite descriptions, factive verbs like *regret*, *be surprised*, etc, aspectual verbs like *stop* or *continue*, particles like *again* or *too*, cleft-constructions, and so on (as many readers will surely know, the complete list is much, much longer). The presupposition triggered by an anaphoric expression is that an antecedent for it can be found in the context. The proposals that have just been mentioned are all formulated within the framework of DRT.

One consequence of such a unified treatment of presupposition and anaphora is that anaphoric expressions impose, just like other presupposition triggers, constraints in context. At the same time such a treatment highlights the "anaphoric" dimension of arbitrary presuppositions: Not only pronominal "presuppositions" act as pointers to information provided earlier, this is a feature of presuppositions in general; all presuppositions are "anaphoric" in the sense of linking the sentence or sentence part in which they originate with the relevant part of the context that serves as background for the interpretation of that sentence or sentence part. In this way, i.e. by linking a sentence or sentence constituent to those parts of the context where the required information is found, presuppositions foster and consolidate discourse coherence. As we will see below, this cohesion-creating effect of presuppositions is closely connected with presupposition *accommodation*, i.e. with the adaptation of an initially insufficient context in such a way that the given presuppositions can be seen to be justified after all by the adjusted context.

Our exposition will proceed as follows. In Section 4.2 we first give some elementary illustrations of how the present account of presupposition works, using examples which are taken from [van der Sandt1992] (modulo some trivial alternations). The notation we use differs cosmetically from the one found in Van Der Sandt's paper. More importantly, our treatment of definite descriptions differs from his, as well as from his and our treatment of anaphoric pronouns. This is an issue to which we devote a somewhat longer discussion, motivated by the consideration that the logical and philosophical tradition has for the most part treated descriptions and pronouns as separated by a major divide, with pronouns the paradigmatic variables of natural language and definite descriptions the prototypical presupposition triggers. Following this some further variants on the pattern of these examples are discussed. These variants are chosen in order to illustrate local presupposition justification, as the source of non-projection.

Section 4.2 ends with a few examples which bring out some of the complexities that arise when other kinds of presuppositions are taken into account besides those

presupposition trigger

coherence

presupposition ! accommodation

on which Van Der Sandt's paper focusses and to which we limit ourselves in the first two parts of this section. A further aim of this section is to reveal some of the intricate interactions that are often found between presuppositions connected with different presupposition triggers occurring within one and the same sentence. Section 4.3 presents the syntax for the DRT formalism in which the preliminary representations of the present account are expressed, and a model-theoretic semantics to go with it. As part of this we define the notions of global and local context, as well as one way of distinguishing between "anaphoric" and "non-anaphoric" presuppositions. Section 4.4 is devoted to presupposition resolution and accommodation and Section 4.5 to the principles according to which preliminary representations are constructed from syntactic trees.

presupposition ! accommodation

4.2 Examples

Pronouns and Definite Descriptions in Simple Sentences

We begin by looking in some detail at the following examples (cf [van der Sandt 1992]).

presupposition ! pronoun

presupposition ! definite descriptions

- (142) a. Walter has a rabbit and a guinea pig. The rabbit is white.
 b. Walter has a rabbit and a guinea pig. His rabbit is white.
 c. Walter has a rabbit. It is white.

We start with (142.a). We assume that processing of the first sentence yields the DRS (143), and that this DRS represents the context within which the second sentence, *It is white.*, is to be interpreted.³⁴

(143)	w y z Walter(w) rabbit(y) guinea pig(z) have (w,y) have (w,z)
-------	--

The preliminary representation of the second sentence contains a presupposition that is triggered by the definite description *the rabbit*. What form should the representation of this presupposition take? This question leads us directly to one of those central issues in the theory of presuppositions which the Dynamic approach has brought into sharper focus. Definite descriptions have been considered the prototypical cases of presupposition-triggering, since the time where the notion of presupposition was recognised as important to the theory of meaning and logic.

³⁴In dealing with the examples in (142) we revert to the mode of representation in which temporal relations are ignored. We will return to representations which take temporal reference into account later on (starting with example (163)).

In fact, it was they who gave rise to this issue in the first place. Frege, one of the two fathers of modern formal logic,³⁵ noted that the referential function of singular definite descriptions of the form *the N* is compromised by failure of either the associated existence condition – *there is at least one N* – or the associated uniqueness condition – *there is at most one N*. So he saw the conjunction of these two conditions as the presupposition that must be satisfied in order that the description can perform the function for which it is intended: refer to the unique x such that $N(x)$. If the presupposition is not satisfied, then, Frege thought, any sentence containing the description will fail to have a proper truth value, with unforeseeable consequences for the logic of formal systems into which definite descriptions are admitted. The proposals to which Frege's worries about presupposition gave rise during the following 75 years seem to have been concerned almost exclusively with definite descriptions, from Russell's Theory of Descriptions ([Russell1905]) to Strawson's revindication of the Fregean perspective ([Strawson1950], [Strawson1964]), and the literature that arose out of the debate provoked by Strawson's 1950 publication in the course of the years following it.

It was not until the late sixties that presupposition became an active concern within linguistics. One important effect of this was that presupposition came to be seen as a much more general phenomenon, of which the presuppositions of definite descriptions are only one among many different manifestations. But even since that time the presuppositions of definite descriptions have retained much of their paradigmatic status.

As said, the logicians of the end of the 19-th and the first half of the 20-th century took the presupposition of a singular definite description *the N* to be the proposition that there exists a unique individual satisfying the predicate N . It cannot but have been clear from the start that the definite descriptions used in ordinary conversation hardly ever satisfy this proposition when it is taken literally. (142.a) is a case in point. Noone who hears (142.a) will take it to imply that there is only one rabbit in the entire universe. Insofar as the uniqueness requirement applies to this case, it is only in the sense that the satisfier of the predicate *rabbit* is uniquely determined within the context in which the sentence containing the description (the second sentence of (142.a)) appears. This context can be seen as providing a restricted set of individuals, and it is only within this set that *rabbit* can be assumed to have a unique satisfier. In our example this condition is fulfilled when we take the context to be given by (143), and the context set as given by its DRS-universe $\{w,y,z\}$. For in light of the information which (143) makes available about the represented entities, it seems safe to conclude that only one of them is a rabbit.

It follows that a plausible version of the existence-and-uniqueness presupposition for singular descriptions will have to allow for contextual restriction. We represent this restriction in the form of a predicate C (cf. [von Fintel1994], ??). In particular, the representation of the existence-and-uniqueness presupposition for

³⁵We take it as established that the predicate calculus, the fundament on which all modern logic rests, was invented – or, if you prefer, discovered – independently by Frege and Peirce.

the rabbit in (142.a) takes the form given in (144.a).

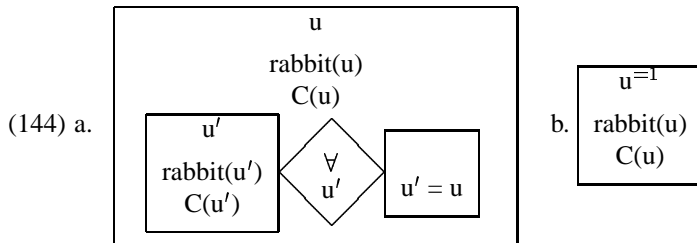

We will abbreviate a DRS representing the existence-and-uniqueness presupposition for singular descriptions by superscribing =1 to the discourse referent representing the individual the singular description denotes. I.e. the DRS in (144.a) will be abbreviated by (144.b).

The contextual predicate C must, as the term “contextual” implies, be “recovered” from the context in which the description is used. Thus C imposes on the context a constraint which is reminiscent of those imposed by anaphoric pronouns: the predicate C is to be identified with this “antecedent” and the identification should fit the interpretation of the discourse as a whole – more specifically, it should enable the interpreter to see the contextualised existence-and-uniqueness presupposition as fulfilled.

This leads us to the conclusion that the existence-and-uniqueness presupposition of a definite description presupposition comes with a further, more “anaphoric” presupposition, to the effect that an antecedent must be found for the predicate variable C. We represent this latter presupposition in the form given in the DRS (145). (145) treats C as a discourse referent of higher type (that of a predicate of individuals). The only constraint on C, which is entailed by the role that it plays in the existence-and-uniqueness presupposition from which its presupposition derives, is that there must be at least one thing falling under C which satisfies the overt descriptive content of the description – i.e., in the case of our example, that there must be at least one thing in C’s extension which is a rabbit. The underlining of C in the universe of (145) serves as indication that C is anaphoric, i.e. that the context must provide a suitable value for it.

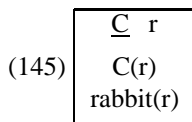

The classical view of the contribution that is made by a definite description to the proposition expressed by the sentence in which it occurs is as follows. On the assumption that the existence-and-uniqueness presupposition of the description is satisfied, the proposition expressed is that some instance of the descriptive content – or, if one prefers, its unique instance; in case the presupposition is satisfied, the distinction doesn’t matter – satisfies the predicate which the sentence asserts of

the descriptive NP. Thus, in our example (142.a) the proposition expressed by the second sentence is that some rabbit (viz. the contextually unique one) is white.

We take it to be implied by this perspective of what proposition is expressed that in a case where the descriptive content is reinforced by a contextual predicate C, this additional predication also becomes part of the content of the proposition. So in particular, the proposition expressed by the second sentence of (142.a) is that some rabbit with the property C is white. Consequently the non-presuppositional part of the preliminary representation must be to the effect that there is something which is a rabbit, satisfies C and is white:

$$(146) \begin{array}{|c|} \hline v \\ \hline \text{rabbit}(v) \\ \text{C}(v) \\ \text{white}(v) \\ \hline \end{array}$$

We represent presuppositions as left-adjoined to those parts of the preliminary sentence representation which represent the parts of the sentence which contain their trigger. Moreover, presuppositions which are generated by other presuppositions are left-adjoined to the representations of those. In the case of the second sentence of (142.a) this means that the existence-and-uniqueness presupposition gets adjoined to the representation of the sentence as a whole, while the anaphoric presupposition concerning C gets left-adjoined to the existence-and-uniqueness presupposition. Thus we arrive at the preliminary representation in (6).³⁶

presupposition ! anaphoric

$$(147) \left\langle \left\langle \left\langle \begin{array}{|c|} \hline \underline{C} r \\ \hline \text{C}(r) \\ \text{rabbit}(r) \\ \hline \end{array} \right\rangle, \begin{array}{|c|} \hline u=1 \\ \hline \text{rabbit}(u) \\ \text{C}(u) \\ \hline \end{array} \right\rangle, \begin{array}{|c|} \hline v \\ \hline \text{rabbit}(v) \\ \text{C}(v) \\ \text{white}(v) \\ \hline \end{array} \right\rangle$$

The final representation of the discourse (142.a) is obtained by combining (147) with the context DRS (143). This combination involves justification of the two presuppositions of (147), the existence-and-uniqueness presupposition and the “anaphoric” presupposition concerning C that is adjoined to it. Resolution of the latter can, we have seen, take the form of identifying the extension of C with the the DRS-universe $\{w,y,z\}$ of the context DRS. (Note that this resolution can be seen to satisfy the constraints of the C-presupposition, since the context (143) carries the information that one of the three represented individuals, that represented by y, is a rabbit.)

The effect of this is shown in (148). The C-presupposition has been eliminated now that the identification of C with the predicate “ $\in\{w,y,z\}$ ” has led to its satisfaction.

³⁶The presence of the curly brackets is explained as follows: In general what gets adjoined to a given part of the representation is not a single presupposition, but a set of them. In (147) both sets are singletons. (When this is the case, the brackets may be omitted without risk of ambiguity.)

$$(148) \left\{ \left\{ \begin{array}{c} u=1 \\ \text{rabbit}(u) \\ v \in \{w,y,z\} \end{array} \right\}, \left\{ \begin{array}{c} v \\ \text{rabbit}(v) \\ \text{white}(v) \end{array} \right\} \right\}$$

The remaining presupposition can now be seen as satisfied by the context DRS (143). But note that to “see” this we must rely on certain assumptions about the world (i.e. on “world knowledge”): (i) The assumption that an individual who owns rabbits and guinea pigs may be assumed to be a person; and (ii) the general knowledge that neither persons nor guinea pigs are rabbits. Such considerations very often enter into the justification of presuppositions. In further examples we will take this world knowledge-related aspect of presupposition justification for granted. It is important, however, to keep in mind how common it is for world knowledge to play some role in presupposition justification.

world knowledge

Given that the presupposition of (148) is justified in (143), it can be discarded as well, and the non-presuppositional part of (148) merged with (143). The result is the DRS (149).³⁷

$$(149) \left\{ \begin{array}{c} w \ y \ z \ v \\ \text{Walter}(w) \\ \text{rabbit}(y) ; \text{guinea pig}(z) ; \text{rabbit}(v) \\ \text{have}(w,y) ; \text{have}(w,z) \\ v \in \{w,y,z\} \\ \text{white}(v) \end{array} \right\}$$

Now consider sentence (142.b). Once more we assume that (143) is the context representation in relation to which the second sentence of the discourse is interpreted. This time the presupposition-triggering subject, the definite description *his rabbit*, contains another definite NP, the pronoun *his*. Since we are aiming for a unified analysis, in which anaphoric expressions are treated as presupposition triggers too, our preliminary representation should also contain a presupposition associated with *his*. We will assume here without further argument that the possessive pronoun *his* can be analysed as decomposable into (i) the masculine singular pronoun (other realisations of which are the forms *he* and *him*) and (ii) a relation expressed by the genitival ending *'s*, which we will take to express a relation of possession between the referent of the pronoun and that of the NP containing it (here: the NP *his rabbit*). For simplicity we will represent this relation as “have(-,-)”, just as we have been representing the verb *have* occurring in the first sentence of (142.a).

pronoun ! possessive

But how should we represent the presupposition triggered by the pronoun? We proceed in much the same way we did in connection with the contextual predicate

³⁷ Whenever atomic DRS-conditions are listed in one line we will separate them with “;”. Note that this use of “;” is not dynamic conjunction – although there would be no truth-conditional difference for the case of atomic conditions. It is only a representational means to separate the elements in the condition set of a DRS.

C: The presupposition presents a discourse referent for the anaphoric element, here x , as requiring an antecedent. Since this is the purport of the presupposition, x appears with underlining (like C in its presupposition in (147)). The choice of x 's antecedent is constrained by some information which the pronoun itself contributes. We make the simplifying assumption that the use of this information, carried by the English third person singular masculine pronoun, is that its referent must be a male person. Note that the underlined discourse referents of anaphoric presuppositions recur in the adjunction sites of these presuppositions. Non-underlined discourse referents, such as u in the existence-and-uniqueness presuppositions of (147) and (148) or r in the presupposition for C in (147), do not.

In (150) below the presupposition associated with the definite description is represented in the same way as before, viz as an existence-and-uniqueness presupposition involving a potential contextual restriction C . The pronoun *his* is part of the definite description *his rabbit* which gives rise to this presupposition. So the presupposition triggered by the pronoun arises in the process of interpreting the content of the description: it is a presupposition which must be resolved in order to determine what this content is. Note in this connection that the discourse referent x , which in the pronoun presupposition plays the role of anaphoric discourse referent in search of an antecedent, also occurs in the specification of the descriptive content of the existence-and-uniqueness presupposition of the definite description (as well as, by implication, in the representation of the proposition expressed by the sentence). Moreover, since the descriptive content is contextually restricted by C , the resolution of the pronoun is also relevant to the resolution of C . So we assume that the pronoun presupposition is left-adjointed to the complex presupposition. With these assumptions we arrive at the preliminary representation in (150).

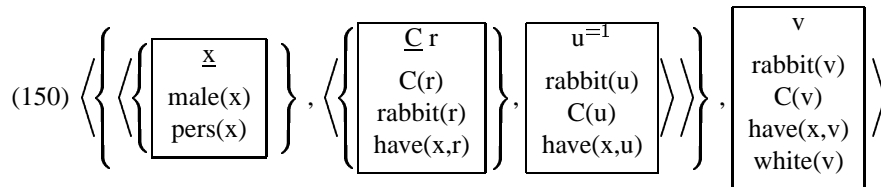

presupposition ! justification

Justification of the presuppositions of (150) within the context DRS (143) proceeds much as before. We now have one more presupposition to deal with, viz. the anaphoric presupposition triggered by *his*. The obvious resolution of this presupposition is that which identifies x with w . Once again the resolution of C to " $\in \{w,y,z\}$ " satisfies the constraints of the C -presupposition itself and guarantees justification of the existence-and-uniqueness presupposition (given the same uncontroversial bits of world knowledge). The resulting representation (151) for (142.b) is nearly the same as that for (142.a) and represents the same truth conditions.

(151)	<p>w y z x v</p> <p>Walter(w)</p> <p>rabbit(y) ; guinea pig(z)</p> <p>have (w,y) ; have (w,z)</p> <p>x = w</p> <p>rabbit(v)</p> <p>$v \in \{w,y,z\}$</p> <p>have (x,y)</p> <p>white(v)</p>
-------	--

Our third example, (142.c), differs from (142.a) and (142.b) in two respects: (i) the first sentence only introduces a rabbit into the discourse, but no guinea pig; and (ii) the subject NP of the second sentence is not a definite description but the pronoun *it*. What has been said in connection with the previous two examples largely determines the way in which we are to deal with this one. The context representation for the second sentence (that is, the representation for the first sentence of (142.c)) is the one given in (152). The preliminary representation, in (153), has only one presupposition, triggered by *it*. Just as we did in connection with *his* in (153.b), we simplify the constraints which it imposes on what sort of entity its referent can be, assuming simply that its referent must be a non-person. Note also that, like we saw in (150) for the discourse referent introduced by *his*, the distinguished discourse referent *u* of the anaphoric presupposition recurs in the non-presuppositional part; lastly, the result of combining (152) and (153) yields, via the only conceptually admissible resolution of *u* (the one which identifies *u* with *y*), the DRS in (154).

(152)	<p>w y</p> <p>Walter(w)</p> <p>rabbit(y)</p> <p>have (w,y)</p>
-------	--

(153)	$\left\langle \left\langle \begin{array}{c} \underline{u} \\ \text{non-pers}(u) \end{array} \right\rangle, \text{white}(u) \right\rangle$
-------	---

(154)	<p>w y u</p> <p>Walter(w) ; rabbit(y) ; have (w,y)</p> <p>u = y</p> <p>white(u)</p>
-------	---

In the treatment of the examples (142.a-c) we have stuck as closely as possible to the traditional distinction between (a) definite descriptions as expressions whose

denotation presupposes existence and uniqueness of descriptive content and (b) pronouns as anaphoric expressions, whose interpretation requires that they must be found an antecedent. Since, as we have seen, the definite descriptions of our examples cannot be analysed in this classical manner unless we allow for contextual restriction of their descriptive content, the two analysis strategies do not appear as radically different as they seem according to the logical picture that emerges from the by now “classical” literature in the philosophy of language, including the writings of Frege, Strawson and Quine, according to which a definite description is a singular term the use of which is subject to the truth of a certain presupposed proposition, while anaphoric pronouns are seen as the “variables of natural language”.

Nevertheless, it might be thought that we haven’t pushed the unified treatment of pronouns and definite descriptions far enough. In fact, many current analyses of definite descriptions treat them (or at any rate treat many of them) much more on a par with pronouns than we have done here.³⁸ In these analyses definite descriptions introduce, like pronouns, anaphoric discourse referents, while their descriptive content is treated as a restriction that must be satisfied by the antecedent for this discourse referent. For example, the definite description *the rabbit* in the second sentence of (142.a) gives rise, on such an analysis, to the anaphoric presupposition shown in (155).

$$(155) \left\langle \left\langle \begin{array}{c} \underline{u} \\ \text{rabbit}(u) \end{array} \right\rangle, \begin{array}{c} \text{white}(u) \end{array} \right\rangle$$

On the analysis of definite descriptions which (155) exemplifies they are anaphoric NPs, which differ from pronouns only in that they are capable of providing more specific descriptive content. Favouring such a closely parallel treatment of pronouns and descriptions is the following consideration. Compare (142.c), in which the use of the pronoun *it* is coherent and unambiguous, with (156), in which it is not.

(156) *Walter has a rabbit and a guinea pig. It is white.

The incoherence of *it* in (156) derives, it would appear, from its inability to distinguish between the two non-persons represented in the context, the rabbit and the guinea pig. (A description which doesn’t discriminate between these two, such as, say, *the rodent* or *the furry creature*, would do just as poorly.) But *the rabbit* does fine, given that we all know that guinea pigs aren’t rodents and that Walter, who “has” a rabbit, is therefore presumably not a rabbit himself.³⁹ It might seem from

³⁸An example is the paper [van der Sandt1992] itself, which has been the major inspiration for the theory sketched in this section.

³⁹The circumstance that the descriptive content “rabbit” of the definite description *the rabbit* matches the constraint “rabbit(y)” on the discourse referent *y* of (152) and that it doesn’t match the descriptive constraint of the other discourse referents in the universe of (152), is enough for the interpreter to

these considerations, that anaphoric pronouns and definite descriptions differ only in their descriptive content.

However, there are also considerations on the other side, which speak against such a rapprochement between our analysis of descriptions and pronouns. Arguments to this effect can be found in many places in the philosophical and semantic literature. Here we mention only one, which has to do with “bridging”. Compare the pair of discourses in (157).

- (157) a. Bill is a donkey owner. The donkey is not happy.
 b. Bill is a donkey owner. ? It is not happy.

The interpretation of the donkey in (157.a) can be justified as follows: The first sentence entails that there are one or more donkeys that Bill owns. So this information can be regarded as part of the context in which the description has to find its reference. In order to justify the singular definite NP we have to “accommodate” the assumption that Bill’s donkey ownership involves a single donkey only, but in the interpretation of (157.a) this does not appear to pose a problem. Consider now (157.b). Here too the content of the first sentence allows us to extend the context universe from the set consisting just of Bill (the only individual explicitly mentioned) to one which contains in addition the donkey or donkeys he owns. If we suppose that the only distinction between *the donkey* and *it* concerns the descriptive contents of their respective presuppositions – that of *the donkey* is to the effect that its antecedent satisfies the predicate “donkey” and that of the pronoun that it satisfies the predicate “non-person” – then the fact that (157.a) is fine but (157.b) is not, becomes a mystery. For the predicate “non-person” is all we need to distinguish the donkey or donkeys owned by Bill from Bill himself. So, on the accommodated assumption that Bill’s donkey ownership involves a sole donkey, the pronoun should be just as effective in this case in selecting the intended antecedent as the description. But apparently it isn’t.

This example points to a conclusion to which many other case studies point as well: An antecedent for a pronoun must have been introduced explicitly into the discourse beforehand; definite descriptions are happy to pick up entities whose existence is implied by the context, even if no explicit introduction has previously taken place.

This difference between pronouns and definite descriptions indicates that a uniform treatment of the two will go only so far. A theory which treats both pronouns and descriptions as anaphoric NPs will need an additional component which articulates the “anaphora resolution principles” according to which the antecedents for

“zero-in” on *y* as the antecedent for *u*. It might be thought that such an interpretation carries with it the accommodation that the individuals represented by the other discourse referents are not rabbits. But this isn’t always so. For instance, consider *A man went to see a doctor. The doctor asked the man what was wrong with him.* Interpreting *the man* as anaphoric to *a man* doesn’t carry the implication that the doctor is not a man. Nor does interpreting *the doctor* as anaphoric to *a doctor* carry the implication that the man who came to see him wasn’t a doctor too.

presupposition ! justification

presupposition ! accommodation

resolution ! anaphora

these two different NP types are determined. The analysis of definite descriptions we have exemplified in our treatment of (142.a) and (142.b) could be seen as a step in this direction. According to that analysis the anaphoric dimension of definite descriptions is located entirely in the determination of the contextual predicate C. However, if this is the way in which we want to make fully explicit precisely how descriptions differ from pronouns, then we will have to say much more about the rules according to which C may be resolved. This is arguably the central task for a theory of Bridging. It is a task on which some progress has been made in recent years, but which surely isn't yet completely solved. (See [Heim1982], [Bos *et al.*1995], [Clark1997], [Asher and Lascarides1998])

bridging

Summarising: It remains a question for further research exactly to what extent the analyses of definite descriptions and pronouns can be unified. We have seen that treating both as triggers of anaphoric presuppositions shifts the burden to articulating the different principles which govern the resolution of these presuppositions. Analysing definite descriptions, in the spirit of the logical tradition, as triggers of contextualised existence-and-uniqueness presuppositions brings out the difference between them and pronouns more clearly in principle, but work remains to be done as regards the contextual resolution of the anaphoric predicate variable C.

We have spent what may seem a disproportionate amount of space in this section on the analysis of pronouns and definite descriptions, and especially on the question how similar or dissimilar their analyses ought to be. Our justification for this is twofold. First, the analysis of pronouns and definite descriptions is a matter that has been of central importance in the philosophy of logic and language for well over a century. Second, the light in which these two NP types appear from the Dynamic perspective is radically different from the traditional picture, according to which anaphoric pronouns are variables and definite descriptions some species of referential term. (This is a view which, if we are not mistaken, is still prevalent among many philosophers and philosophical logicians today.) According to this view the two kinds of expressions are very different indeed. The Dynamic approach, however, makes it possible to see that, certain remaining discrepancies notwithstanding, the conceptual differences are far smaller than the traditional picture implies. All in all Dynamic Semantics (at least in the form in which it is being used here) projects a very different image of the way in which reference contributes to the expression of propositions, and to the range of possibilities of expressions which serve a referential role within the setting of dynamic interpretation.

Local vs global Justification

The examples we consider in this section are variants of those considered in Section 4.2. They have been chosen to show the difference between global and local justification of presuppositions. We will focus on just two logical sentence types, a conditional sentence (158.a) and a universal quantification (158.b).

presupposition ! justification

justification ! global

justification ! local

conditional

quantification ! universal

- (158) a. (It is a peculiar fact, but) If a friend of mine has both a rabbit and a guinea pig, the rabbit is white.⁴⁰
 b. Every friend of mine who has a rabbit overfeeds it.

The point of these examples is that the presuppositions associated with the definite description of (158.a) and the pronoun of (158.b) do not seem to “project”. They don’t, because they can be resolved in local contexts that are furnished by some other part of the sentence (the antecedent of the conditional or the restrictor of the quantification) than the part in which they are triggered (the conditional’s consequent or the quantifier’s nuclear scope). We note in passing that the *it* of (158.b) is a typical donkey pronoun.

presupposition ! projection

The analysis of (158.a) resembles in most respects the one we gave in the last section of (142.a). The difference is that the presupposition is now adjoined to some embedded part of the preliminary representation (the consequent of the conditional), since it is this part that represents the sentence constituent which contains its trigger.

Adopting the same treatment of the definite description *the rabbit* which we used in our treatment of (142.a) we get as preliminary sentence representation the structure in (159), where $K_{(147)}$ stands for the preliminary DRS in (147).

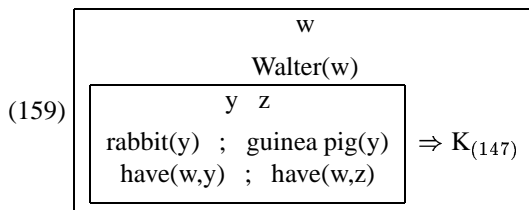

Note that the discourse referent *w* introduced by the NP *Walter* has been placed in the universe of the main DRS, not in that of the sub-DRS representing the antecedent of the conditional. In the original top-down construction algorithm for DRT (See Section 2) this was the effect of the processing rule for proper names. But in the present setting, where we have already committed ourselves to presuppositional accounts of pronouns and descriptions, it is natural to adopt an account also for other types of definite NPs, such as proper names and demonstratives. For each of these NP types the account must include an articulation of the resolution rules for the presuppositions generated by the NP in question. In the first part of this subsection we noted in relation to descriptions that determining what these resolution rules is anything but a trivial task, which a large spectrum of earlier investigations into the semantic and pragmatic behaviour of the given NP type requires taking account of. For other types of definite NPs the situation is no different. This is true in particular for proper names, whose referential properties have

proper name

⁴⁰The initial part of (158.a) in parentheses is intended to make the sentences a little less implausible, but the discussion will not take it into account.

been the subject of countless publications within the philosophy of language, and, more recently, also within linguistics.⁴¹ The fact that the referent of a proper name occurring in a discourse always finds a representation within the global context should come out as a consequence of the resolution rules for the presuppositions triggered by proper names.

We forgo an explicitly presuppositional treatment of proper names⁴² here, and simply assume that the ultimate result of their interpretation is always representation at the level of the main universe of the sentence or discourse representation. There is one aspect to the use of proper names, however, which should be mentioned here. This is the ease with which they (or, in the present terminology, their presuppositions) are “accommodated”. We have made passing mention of accommodation in the last section, and will have cause to do so a few more times until Section 4.4, in which accommodation is the topic. What matters right now are two points: (i) What sorts of information may be accommodated for the sake of justifying a given presupposition, and under what conditions, varies from one type of presupposition to the next (cf. the discussion of bridging as a form of accommodation that is permissible in the case of definite descriptions but not of pronouns); and (ii) Accommodation is particularly unproblematic in the case of proper names: In cases where the interpreter of an occurrence of a proper name is unfamiliar with that name, or believes himself to be unfamiliar with the name’s referent, he will normally assume that the speaker who is using the name knows who she is talking about. Accordingly he will accommodate his interpretation context so that it contains a representation of the intended referent of the name, to which the discourse referent introduced by the given name occurrence can then be linked. We will assume henceforth that a name which does not as yet have a representation in the context will automatically lead to an accommodation of this kind.

Justification of the presupposition of (159) whose representation is adjoined to the representation of the consequent of the conditional can make use of the local context information that is provided by the antecedent – just as justification of the presuppositions of (147) could make use of the discourse context (143) provided by the preceding sentence. It is important to note, however, that the local context information is not restricted to the contents of the relevant sub-DRS itself, but includes also all information that belongs to other DRSs which are accessible from the local context. Thus, in the case at hand the discourse referent *w* and the condition “Walter(*w*)”, which are not part of the sub-DRS representing the antecedent of the conditional, but of the main DRS, which is accessible from this sub-DRS, are part of the local context information too. It follows from this that if one context is more local than another (i.e. the second is accessible from the first, but not conversely), the first will always contain at least as much information as

⁴¹Much of the philosophical literature of the past thirty years was in reaction to Kripke’s *Naming and Necessity* ([Kripke1972]). For an analysis of proper names that is directly relevant to the presuppositional account that is at issue here, see [Geurts1997].

⁴²Likewise for the various types of demonstratives. Demonstratives, however, won’t occur in any of the examples we discuss in this survey.

presupposition ! accommodation

presupposition ! justification

accessibility

the second, and usually more.

This means among other things that resolution of C in the local context provided by the antecedent of the conditional in (159) can take the same form as it did in our treatment of (142.a), viz. that of identifying C with the predicate “ $\in\{w,y,z\}$ ”. After this identification, the effect of which results in replacing the DRS-component $K_{(147)}$ in (159) with $K_{(148)}$, satisfaction of the existence-and-uniqueness presupposition of the definite description follows as before and we end up with the presupposition-free sentence representation in (160).

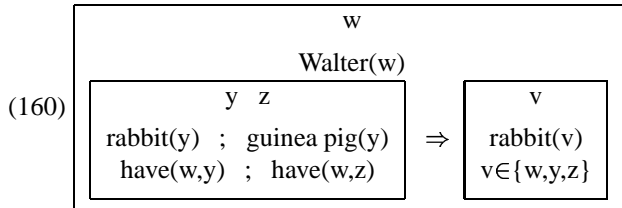

Inasmuch as the presuppositions of (159) have been justified on the strength of information provided by the antecedent of the conditional alone, we have accounted for why these projections do not project to become presuppositions of the conditional sentence as a whole. However, we should recall in this connection the observation made in the last section regarding our treatment of (142.a): The justification of the existence-and-uniqueness presupposition rests strictly speaking not only on the information explicitly provided, but also on further assumptions, such as that Walter is a human being and that human beings are not rabbits. Because of this it isn't strictly speaking true that the local justification of the presuppositions of (158.a) described here makes them disappear without any trace whatever. In a context in which these assumptions could not be made, (158.a) would impress the interpreter as infelicitous. However, for the sentence in question such contexts are unlikely and in general, there will be a presumption, shared by speaker and interpreter, that the context is not like this. Because of this general default assumption a sentence like (158.a) will appear to us as free of presuppositional constraints on context altogether.

presupposition ! projection

Much the same treatment as the one we just presented for (158.a) is possible for (158.b). The presupposition triggered by *it* is now adjoined to the right hand side DRS of the duplex condition introduced by the quantifier *every friend of mine*. (161) gives the preliminary representation of the sentence and (162) the final sentence representation.

quantifier ! universal

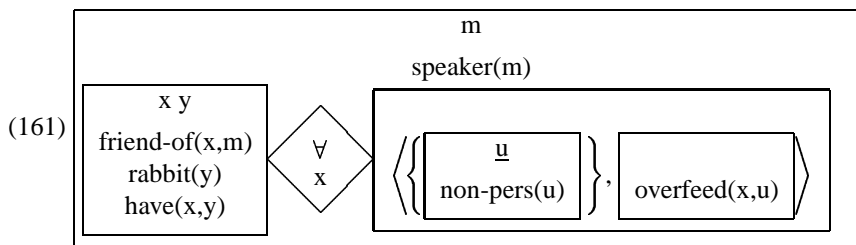

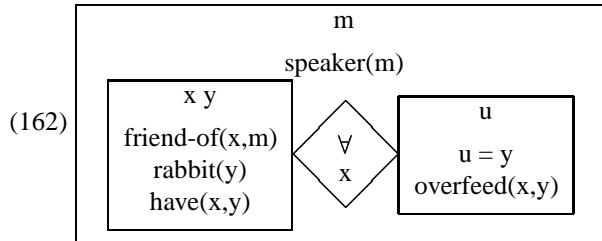

Examples involving presupposition triggers distinct from definite noun phrases

In this section we look at examples which involve presupposition triggers that are not NPs. The first of these is a factive verb, *be surprised that*, and the second the adverb *again*. We begin with sentence (163).

(163) Bill is surprised that he is late.

Factive verbs presuppose the truth of their clausal complements. Within the setting of the present account this means that in the preliminary representation the representation of the complement sentence must occur more than once – first, as argument of the attitudinal predicate expressed by the verb, and, second, as factive presupposition. This need for representation duplication is extremely common. It arises in all cases of factive presupposition and with many other presupposition triggers as well. Moreover, the duplication problem doesn't arise just in the context of presupposition. It is equally important in connection with ellipsis, and in that connection it has received a good deal of attention.⁴³ Here we will only be concerned with aspects of the problem that are specific to its manifestations in the context of presupposition.⁴⁴ Duplication poses a major problem: the duplicate representations must identify the same content. Strictly speaking we are dealing with just *one* interpretation of the sentence material for which duplicate representations seem required; the duplicate representations must all capture the content captured by *that* interpretation.

One way in which this duplication problem manifests itself has to do with the interpretation of pronouns occurring within a sentence or sentence part of which duplicate representations are needed. This form of the problem is illustrated by

⁴³See e.g. [Schiehlen1999], [SchiehlenJuly 2002] and the references cited there.

⁴⁴The requirement that multiple representations of the same sentence constituent express the same content is another reason for preferring a bottom-up construction algorithm to one which works top-down. When we work our way bottom up, then normally we will have constructed a representation of the part which requires multiple representation at the point when duplicates of the representation must be introduced into the representation that is being constructed. Disambiguation decisions that sometimes have to be made in the course of representation construction – we assume that syntactic trees may contain ambiguities which are resolved only when they are converted into semantic representations – will already have been made in this case. When we proceed top-down, copying will usually be needed at a point where the relevant part of the syntactic tree has not yet been converted. Special provisions have to be made to make sure that afterwards the same disambiguation decisions will be made in each of the copies.

(163), where the anaphoric presupposition trigger *he* occurs as part of the representation serving as second argument of the complement of *be surprised* and also as part of the factive presupposition.

To focus more clearly on the problem, let us consider a preliminary representation for (163) in which the *he*-presupposition is represented twice.

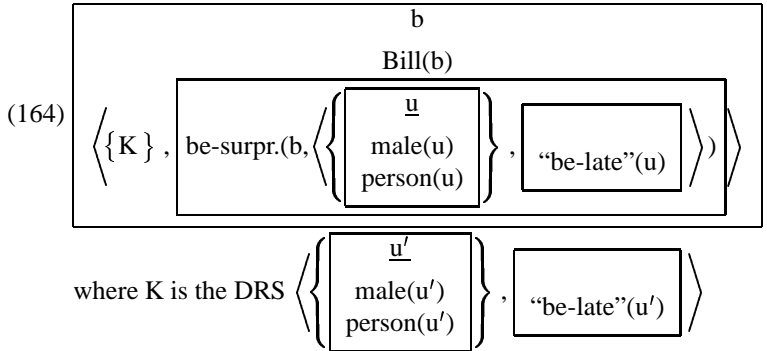

The first thing to observe about (164) is that there will be no way to justify the factive presupposition unless we assume that (163) is used in a context that entails it. However, factive presuppositions are, like those connected with proper names, easily accommodated, and we will assume that this is what happens eventually in this case. But before the factive presupposition can be accommodated it ought to be clear what it is. In the present case this requires that its satellite presupposition, involving the anaphoric discourse referent *u'*, has already been resolved. So it is to the resolution of this presupposition, and of its alter ego involving the discourse referent *u*, that we must turn first.

presupposition ! accommodation

When (163) is considered out of context – or against the background of an empty discourse context, as when it is the very first utterance of a conversation – the difficulty that multiple copies of anaphoric presuppositions can cause doesn't become visible yet. For in such a situation only Bill is available as anaphoric antecedent for both *u* and *u'*. Resolving the two pronoun presuppositions accordingly leads to the representation in (165).

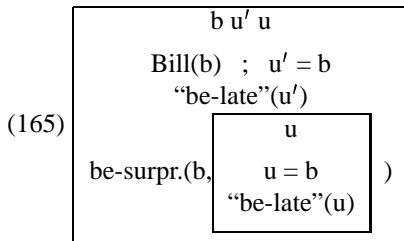

In (165) the representation of the second argument of *be-surprised* and that of the factive presupposition do express the same proposition, viz the *de re* proposition which asserts of Bill that he is late. This is as it should be. But we cannot count on

being so lucky always. Things may go wrong when a sentence like (163) is used in a non-empty context like that which is provided by the first sentence of (166).

(166) John was late and that's what he told Bill. Bill isn't surprised that he was late.

The context established by the first sentence of (166) contains the information that John was late and that John has told Bill that this is so. Among other things it introduces (representations for) John and Bill. So the pronoun *he* in the second sentence is now ambiguous between an interpretation in which it refers to Bill and one in which it refers to John. Once again we assume that the preliminary representation (now for the second sentence of (166)) is as in (164). Suppose we were to resolve u' to John and u to Bill. This would give us on the one hand satisfaction of the factive presupposition in the context due to the first sentence (since the first sentence asserts that John was late). On the other hand the non-presuppositional part of the sentence representation now says that Bill isn't surprised that Bill was. It is plain, however, that the factive presupposition of *that* claim isn't justified by the first sentence of (166). So the presupposition justification we obtain in this way is spurious. Evidently it won't do to resolve u and u' to different antecedents.

There are various ways in which the requirement of a common resolution for the discourse referents u and u' of the duplicate presupposition representations can be secured. One possibility is to insist that different copies of the same anaphoric presupposition all use the same distinguished discourse referent, and then to insist that different such occurrences (i.e. underlined occurrences) of the same discourse referent in the same representation just get the same antecedent. In the case of (164) this would mean that instead of the two discourse referents u and u' we would have just one – u , say – occurring as distinguished discourse referent in both.)

These remarks are no more than suggestive. They can be turned into something more precise only within the context of an explicit construction algorithm for preliminary representations. This is of course a very important part of the theory of presupposition that is presented in this section. And not only that, it is a crucial part of the version of DRT presented here, given that presupposition (with anaphors as special case of it) is the central phenomenon that DRT should be able to account for. Unfortunately a systematic treatment of DRS-construction – the construction of preliminary sentence representations and the integration of these into discourse representations – would transcend the already strained boundaries of the present chapter. We will say a few words about the two phases of DRS construction in Section 4.4 and 4.5, respectively. For a more detailed treatment we point the reader to the forthcoming [Hans and Reylems].

We conclude this discussion with one last remark. on factive presuppositions here. As a rule factive predicates serve the purpose of attributing propositional attitudes. Such predicates do not only give rise to factive presuppositions, but also to presuppositions to the effect that the content of the attributed attitude is something

that the attributee himself believes (or even takes for granted). At this point we are lacking the means to represent such “doxastic” presuppositions adequately. Once we will have procured these means in Section 5, we will return to the presuppositions of factive verbs.

Our next example involves the presupposition trigger *again*. *again* triggers a presupposition to the effect that the event or state described by the sentence constituent to which it is adjoined was preceded by an event or state satisfying the same description.⁴⁵ To account for such presuppositions we must be able to represent the temporal aspects of natural language meaning. So we now need as our basic DRT-language, which provides the building blocks from which preliminary representations are built, one in which events, states and their temporal properties and relations are made explicit. We take as underlying language the DRS language of Section 3.5. (See also [Kamp and Reyle1993].)

First consider the sentence (167), with the preliminary representation in (168).⁴⁶

(167) John made a mistake again.

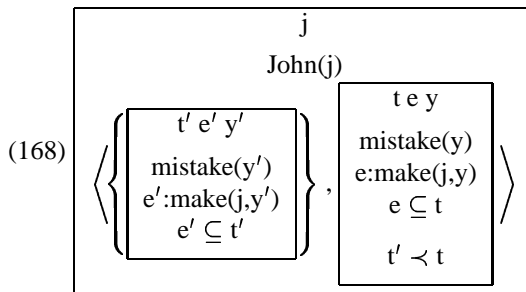

The aspect of (168) that requires more extensive discussion is the placement of the condition “ $t' \prec t$ ”. This condition expresses that the presupposed eventuality precedes the asserted one and this is clearly needed. But where should we put it? In (168) it has been inserted into the non-presuppositional part of the representation, to which the *again*-presupposition has been adjoined. The reason for doing this is

⁴⁵This is an oversimplification. As has been noted by several authors ([Fabricius-Hansen1980],[Fabricius-Hansen1983],[Stechow1996]), *again* is ambiguous between a *repetitive* and a *restitutive* interpretation. The difference is most clearly seen with certain telic verbs, for instance, the verb *cure*. In *The tourist came down with typhoid, but the local doctor cured him again*. The word *again* can either be interpreted as presupposing that there was an earlier event of the doctor curing the patient (the repetitive reading), or as presupposing that before the time when the tourist came down with typhoid he was in a state of being healthy (or at least typhoid-free) and that this state of affairs is “restituted” by the curing event whose occurrence is asserted by the sentence (the restitutive reading). Here we will only consider repetitive readings.

⁴⁶The representation given here of the VP *make a mistake* is not really satisfactory. First, it isn't right to analyse *make* as a relation between the subject Bill and some independently existing object, the mistake. *make* functions as “verb of creation” here and the mistake is what results from the event it describes. Second, *make* acts as a light verb. The relation it contributes cannot be determined from the verb by itself, but only in combination with the head noun *mistake* of its direct object. We will return to these problems in Section ??.

that a presupposition has a certain “logical priority” over the sentence or sentence part to which it is adjoined: The semantic contribution that is made by this sentence or sentence part will be determined only when the presupposition has been resolved. So the presupposition should not be “referentially dependent” on the representation of its adjunction site in the sense of containing a free discourse referent which is bound only in the representation of the adjunction site. But adding the condition “ $t' \prec t$ ” to the representation of the presupposition would create just such a dependency. Hence its appearance as part of the representation of the adjunction site.

There is, however, another intuition which seems to speak against adding “ $t' \prec t$ ” to the adjunction site representation. *Again*-sentences like (167) seem to be making a certain claim, expressed by the sentence without *again*. *Again* seems to “tag on” a certain presupposition to this claim, to the effect that one or more eventualities of the kind described by the claim occurred before the one whose occurrence is claimed. From this perspective the presupposition is that one or more eventualities of the kind described occurred *before the occurrence time of the asserted eventuality*: The latter eventuality *ev* is said to have occurred at some time *t* and the presupposition is that there were similar eventualities before *t*. This perspective is especially compelling in connection with certain negated *again*-sentences. For instance the second sentence of

(169) Mary came on Tuesday. But she didn't come again on Wednesday.

is naturally glossed as (i) making the claim that there was no coming on Wednesday, and (ii) that there was a coming of Mary at some time before Wednesday (a presupposition which is justified by the first sentence of (169)).

But for non-negated sentences such as (167) the perspective is plausible as well. It is easy to imagine a context in which a certain past time is already in focus and in which the of (167) is understood to locate the event it describes. In fact, as we saw in Section 3.5, tenses are often anaphoric in several ways; now that we have reinterpreted anaphora as a species of presuppositions we can make this anaphoric dimension more explicit by representing the location time *t* of the asserted event as involving an anaphoric presupposition of its own. In a preliminary representation in which *t* is treated in this way, the *again*-presupposition can now be made dependent on this first presupposition, without it thereby becoming dependent on the non-presuppositional part of the representation. Such a preliminary representation is given in (170).

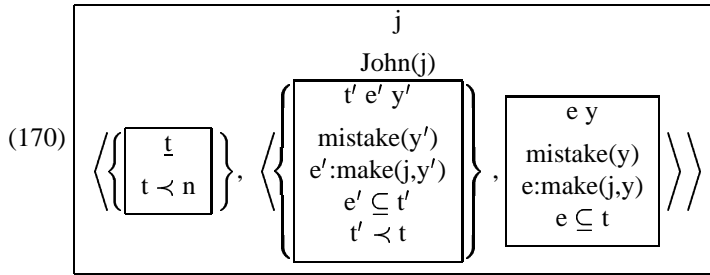

An interesting feature of *again*, which it shares with anaphoric words such as *else*, *other* and relational adjectives such as *similar*, *related* etc., is shown by the following pair of discourses.

- (171) a. I will help Bill tomorrow. But I won't help him again.
 b. I will help Bill tomorrow. But I will not help him.
 c. I will help Bill tomorrow. But I will never help him again.
 d. I will help Bill tomorrow. But I will never help him.

(171.b) and (171.d) are bizarre and can only be interpreted as straight contradictions: the first sentence announces that a certain event will take place tomorrow and the second asserts that no such event will take place (ever) in the future. (171.a) and (171.c) are perfectly coherent. They convey that a certain event will occur tomorrow and that no such event will ever happen *after this one*. Evidently it is the presence of *again* in (171.a,c) and its absence from (171.b,d) which is responsible for the difference.

To account for this contrast we must recall what was said about frequency adverbs and negation in 3.5. The interpretation of both negation and adverbs like *never* involves a frame adverbial, we noted there. This frame adverbial plays the same role in such sentence as does the location time in simple sentences like (167) or the first sentence of (171.a,b); in particular, in sentence with *not* or *never* it is now the frame interval that is involved in the anaphoric location time presupposition displayed in (170). Thus we get for the second sentence of (171.a) which contains *not* the representation in (ref29''), whereas (ref29''') is the representation of the corresponding sentence without *again*.

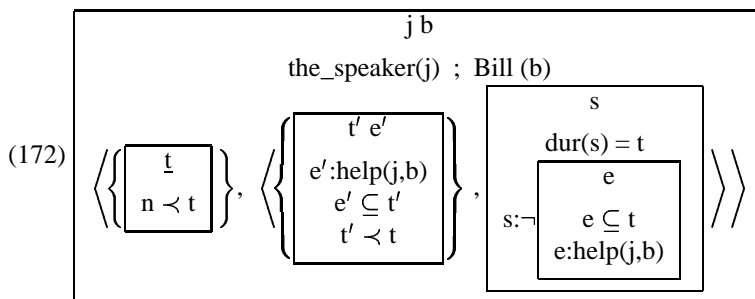

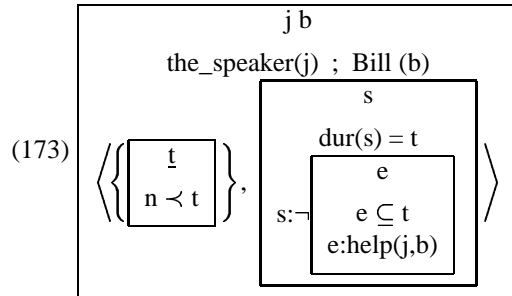

The contrast between (172) and (173) shows that the presence of the *again*-presupposition in (171) creates the possibility of resolving t' to the time t_0 of the event of the speaker helping Bill tomorrow which is asserted in the first sentence and resolving t to the period following t' ($=t_0$). In (173), where the *again*-presupposition is absent, such a resolution of t is apparently not possible (even though the context is exactly the same). We will return to this case in Section 4.5.

There is one further feature of (172) which requires comment here. This is the interaction between *again*-presuppositions and negation.⁴⁷ Even though syntactically *again* is presumably within the scope of negation in (171.a) the presupposition it triggers has been adjoined outside the negation operator in (172). What is the justification for this?

The answer is connected with an aspect of the theory of presupposition that was prominent from the first beginnings. This is the relation between presupposition and negation. (The interaction between negation and *again*-presupposition in (171) is just one instance of this; but the relation equally concerns all type of presuppositions.) In the early days, when presupposition was primarily the concern of logicians it was seen as one of the central features of presuppositions that they equally affect a sentence S and its negation. The presuppositions of $\neg S$ are the same as the presuppositions of S . If the presuppositions are not satisfied, then

⁴⁷Note that the scope relation between the negation and *again* in the second sentence of (??) is also evident semantically. When *again* has scope over a negation, then the negation will figure in the *again*-presupposition. Compare for instance (174.a) – (174.d)

- (174) a. Bill was on time yesterday. But he hasn't been on time again today.
 b. Bill wasn't on time yesterday. And he hasn't been on time again today.
 c. Bill was on time yesterday. *But again he hasn't been on time today.
 d. Bill wasn't on time yesterday. And again he hasn't been on time today.

These examples make two points. First, the oddity of (174.c) shows that when *again* unequivocally has scope over the negation, then the negation is part of the presupposition. The *again*-presupposition of the second sentence of (174.c) and (174.d) says that there was an earlier occasion when Bill wasn't on time. This is precisely what the first sentence of (174.c) does not allow us to justify. (The first sentence of (174.d), on the other hand, does allow this, so (174.d) is unobjectionable.) That both (174.a) and (174.b) are fine shows that there the second sentence is ambiguous between a reading in which *again* has wide scope over the negation and one in which it does not. In our representation of (??) we have been guided by the semantic intuition that here the narrow scope reading for *again* seems the intended one.

neither S nor $\neg S$ is (i.e. have a truth value, or express a proposition); if the presuppositions are satisfied, then both S and $\neg S$ are “proper” (and, of course, of opposite truth value). When presupposition theory became a part of linguistics later on, the question whether an implication is preserved under negation became one of the major criteria for deciding whether the implication is a case of presupposition.

Whithin the setting of present account of presupposition, the fact that presuppositions of S are also presuppositions of $\neg S$ has a simple explanation. Negation is a 1-place operator. (In this regard it differs both from “sentential connectives”, like *and* and *if*, and from natural language quantifiers, like *all*, *most*, *many*, etc., all of which are 2-place (the quantifiers always involve restrictor as well as nuclear scope). As a consequence there is within the scope of the negation no new information that could serve as local context for the justification of a presupposition triggered by the sentence or sentence part on which the negation operates (in the way in which the antecedent of a conditional can serve as context for the justification of a presupposition triggered by the consequent, etc.) So justification of the presupposition will be possible, if at all, only in a context which includes the negation within its scope.

In view of this it is immaterial for the final outcome of the interpretation process whether a presupposition triggered within a negated sentence or sentence part is adjoined under or outside the scope of the negation operator. For instance, we could have represented the second sentence of (171.a) also as in (175), with the representation of the presupposition inside the scope of \neg .

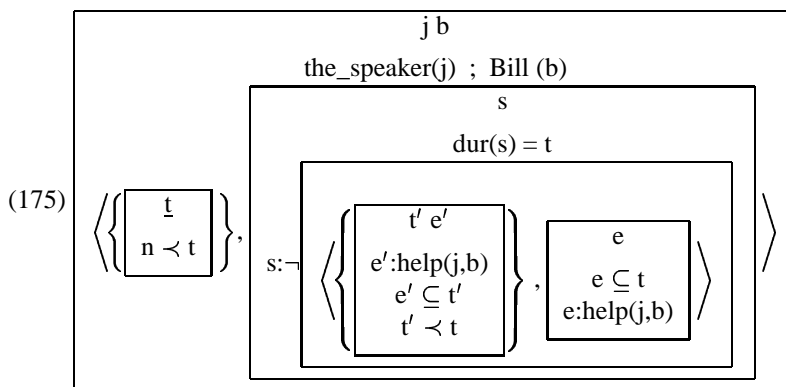

In the context provided by the first sentence of (171) justification of the *again*-presupposition of (175) clearly comes to the same thing as justification of the *again*-presupposition of (172): In both cases justification is in the global context specified by the first sentence, so exactly where the presupposition is adjoined in the preliminary representation of the new sentence is, as far as justification is concerned, of no consequence. The same is true in cases where the presupposition is justified sentence-internally. (Consider, e.g., the conditional with the first sentence of (171.a) as antecedent and the second sentence as consequent.) Here too it does-

n't matter whether the justified presupposition is represented under or outside the negation operator.

Is there any way of choosing between the preliminary representations (172) and (175)? Arguably it is (175) which results directly from the application of the general construction rules to the input structure (i.e. the syntactic structure of the second sentence of (171.a)). (172) can then be seen as a variant of (175) which can be obtained by "lifting" the presupposition "beyond" the negation, relying on the principle that justification of the presupposition is equivalent to justification in a context which has scope over the negation.

(175) is preferable to (172) also for another reason. Sometimes presupposition can be "cancelled under negation". This typically involves denying explicitly that the presupposition is true. A famous example which played its part in the debate between Russel and Strawson over the question whether there is such a thing as presupposition is given in (176.a); (176.b) illustrates the same phenomenon, but in connection with a presupposition triggered by *again*.

- (176) a. The exhibition wasn't opened by the King of France.
 b. I am not reading this paper again. I am reading it for the very first time.

Sentences of this kind are described as instances of "local satisfaction of the presupposition under negation", a term which suggest that what we see in these cases is on a par with non-projection of the kind exemplified by, for instance, We believe, however, that the two phenomena are very different in nature and that the right explanation of what we see in (176) is along the lines of Horn's theory of negation ([]). According to this theory the function of negation is not restricted to denying the truth of the proposition expressed by the sentence material in its scope, but can be extended to cover other factors that can be responsible for failure to produce a felicitous true claim. Failure of presupposition is one of the many factors. There is an ongoing dispute precisely under what circumstances negation can be used to reflect factors other than the actual falsity of a correctly expressed proposition. (In order that a negation can be understood as denying truth of what it applies to because of presupposition failure, it seems necessary that the presupposition must itself be denied explicitly, but probably the last word about what is involved in presupposition cancellation has not yet been said.) However, it should be clear, whatever the details, that presupposition cancellation is an entirely different phenomenon from local satisfaction. In the latter case the presupposition is "locally true"; in the former it is "globally false" and thus a fortiori "locally false" as well.

Local Justification in Conjunctions

In this subsection we briefly address one further instance of local presupposition justification, that of sentence compounds formed with "&-like" conjunctions such as *and*, *but*, *although*, *because* and others. It is one of the standard facts about

anaphora that pronouns to the right of such a conjunction can be construed as anaphoric to an indefinite on the left, but not vice versa. This is so both when the compound is a complete sentence by itself and when it occurs as part of a larger sentence, e.g. as antecedent or consequent of a conditional. The same observations apply to presuppositions that are due to other triggers than pronouns. We restrict our attention here to coordinate structures with the conjunction *and*.

presupposition ! satisfaction
justification ! local

- (177) a. If a friend of mine has a rabbit and he loves it, then he overfeeds it
 b. *If he loves it and a friend of mine has a rabbit, then he overfeeds it
 c. If someone is caught stealing and he is then caught stealing again, he is sent to goal.
 d. *If someone is caught stealing again and he is then caught stealing, he is sent to goal.

From the point of presupposition justification conjunctions thus behave like conditionals and quantifications. It is natural to capture this similarity by representing conjunctions at the level of preliminary representations in the form of complex DRS conditions, composed of the representation for the first conjunct and the representation of the second. This will enable us to specify, by the same means that we used for duplex conditions and conditions formed with \Rightarrow , that the first conjunct serves as local context for the second conjunct.

To form such conjunctive DRS conditions we need an operator to represent the conjunction operator which English expresses by means of the word *and*. From the Dynamic Semantics literature it is clear what symbol we should use for this purpose. Dynamic Semantics, in the more restrictive sense of the term, makes use of the dynamic conjunction operator “;”.⁴⁸ The semantics of this operator stipulates that a conjunction formed with its help is true in a given context K_0 iff (i) the first conjunct is true in K_0 and (ii) the second argument is true in the context obtained from updating K_0 with the information contributed by the first conjunct. This is in essence what we need. And in Section 4.3, where we present the model theory for preliminary DRSs, we will define the semantics of “;” along these lines.

coordination

conjunction

DRS condition ! conjunctive

Using “;” we get for (177.a) the preliminary representation in (178).

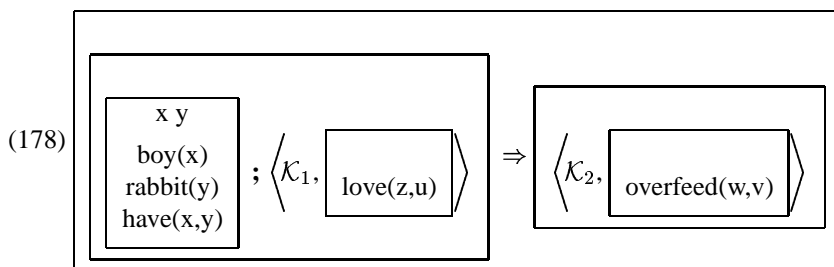

⁴⁸See for instance [Groenendijk and Stokhof1991].

$$\mathcal{K}_1 = \left\{ \begin{array}{|l} \underline{z} \\ \text{male}(z) \\ \text{pers}(z) \end{array} , \begin{array}{|l} \underline{u} \\ \text{non-pers}(u) \end{array} \right\}$$

$$\mathcal{K}_2 = \left\{ \begin{array}{|l} \underline{w} \\ \text{male}(w) \\ \text{pers}(w) \end{array} , \begin{array}{|l} \underline{v} \\ \text{non-pers}(v) \end{array} \right\}$$

We assume that the left sub-DRS of the ;-condition in (178) can serve as local context for the justification of the presuppositions adjoined to its right sub-DRS. This allows for resolution of the anaphoric discourse referents z and u via identification with x and y . The result of this can be represented as in (179).

$$(179) \quad \left[\begin{array}{|l} x \ y \\ \text{boy}(x) \\ \text{rabbit}(y) \\ \text{have}(x,y) \end{array} ; \begin{array}{|l} z \ u \\ z = x ; u = y \\ \text{love}(z,u) \end{array} \right] \Rightarrow \left\langle \mathcal{K}_2, \text{overfeed}(w,v) \right\rangle$$

$$\mathcal{K}_2 = \left\{ \begin{array}{|l} \underline{w} \\ \text{male}(w) \\ \text{pers}(w) \end{array} , \begin{array}{|l} \underline{v} \\ \text{non-pers}(v) \end{array} \right\}$$

What about the justification of the remaining presuppositions, in the consequent of the conditional? Here we face an issue which we have not yet encountered. By representing the antecedent of the conditional (177.a) in (178) as a complex condition inside the left DRS of the \Rightarrow -condition we have created a configuration which seems to render the information inside the DRS components of the ;-condition inaccessible to that in the consequent of the \Rightarrow -condition. Clearly this is not what we want. We could extend the definition of accessibility in such a way that the information in the conjuncts of ; in (179) does become accessible to the consequent. But the same effect can also be achieved in a slightly different way, viz. via the principle that presupposition-free ;-conjunctions can be merged with the DRS to whose condition set the conjunction belongs. The principle is stated in (180).

(180) (Lifting of presupposition-free ;-conditions)

Suppose that a preliminary representation K has a component K' , that K' contains a condition of the form " $K_1;K_2$ " and that this condition is a DRS condition – that is, both K_1 and K_2 are free of presuppositions. Then K' may be replaced in K by the merge of K' , K_1 and K_2 .

Applying (180) to (179) gives (181), in which the remaining presuppositions can now be resolved in the manner desired. The final representation is (182).

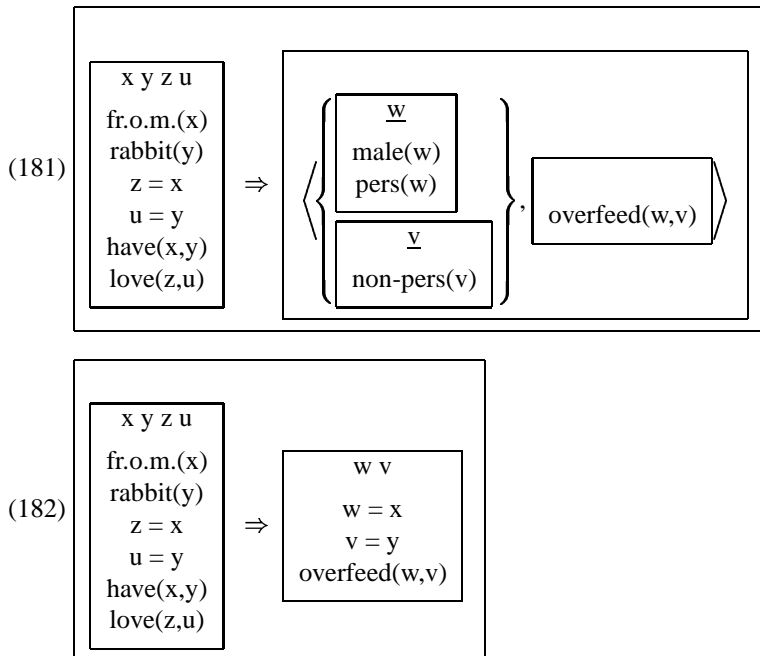

Applications of principle (180) seem to introduce into the justification process a genuine element of sequentiality. For instance, in (179) we must first resolve the presuppositions involving z and u , then apply (180) and then resolve the remaining presuppositions. In this regard the processing order that is imposed on (179) differs from the cases discussed in the last section. There too, presupposition resolution often seemed to be a matter of preceding in the right order. For instance, in discussing the *again*-sentence (167) we attributed a logical priority to the resolution of the presupposition for the location time t over the presupposition triggered by *again*. But it is nevertheless possible to understand presupposition resolution for a given preliminary representation as a single problem, that of the simultaneous solution of a set of (presuppositional) constraints: each constraint resolution must be chosen in such a way that all fit together. In Section 4.5 we will look at examples which bring out this aspect of simultaneous constraint solving very clearly.

Principle (180) appears to change this picture. Usually it requires that certain resolutions have already been carried out while other resolutions are possible only once the application has occurred. But of course this doesn't alter the spirit of simultaneous resolution. Even in the presence of (180) it remains true that the earlier resolutions should be carried out in such a way that the later ones remain possible. In fact, we can eliminate the element of sequentiality which the introduction of (180) introduces by redefining accessibility (as suggested earlier), and leaving

(180) merely as a means for simplifying the notation of presupposition-free representations. But this is an alternative we won't pursue further here.⁴⁹

We noted that *and* is only one of a number of words that form logical conjunctions in English. In some cases, like in that of *and* itself these conjunctions take the form of coordinations and in others (e.g. *because*) that of subordinations; but in all these cases left-to-right order matters to anaphoric an presupposition resolution, and therefore requires the use of ; in preliminary representation for the same reasons why it is needed in the representation of conjunctions with *and*. (There is a complication with subordinate conjunctions. When the subordinate clause precedes the main clause, resolution may “go in either direction”, with the main clause serving as context for the justification of presuppositions arising within the subordinate clause as well as the other way round. These cases require a more complex analysis, which we do not go into here. (For the case of pronominal anaphora see [Chierchia1991].)) But it is not only coordinate and subordinate conjunctions which require the use of ;. The effect of linear order on presupposition resolution makes itself felt in many other as well. One type of case involves relative clauses. An example is given in (refhappy).

(183) A man who loves a woman who also loves him ought to be happy.

Here *him* can (and is naturally understood to) refer to the discourse referent introduced by *a man* and also is appropriate in that the proposition expressed by the clause to which it is adjoined – that of the woman *y* loving the man *x* – is parallel in the way required for the interpretation of *also* to the proposition that *x* loves *y* which “precedes” it. It is a well-known point of generative syntax that reversal of *him* and its antecedent destroys this interpretation and the same can be observed when we move *also* from the inner to the outer relative clause.

(184) a. He who loves a woman who also loves a man ought to be happy.

⁴⁹One reason for dwelling on the case of conjunction has to do with the history of DRT. The problem was known from the earliest days of DRT, at least in its application to anaphoric pronouns. In [Kamp and Reyle1993] it was discussed at considerable length (see Ch. 1.5). But the solution presented there, involving a baroque indexation system which takes away much of the initial appeal of DRSs as comparatively simple data structures, can be euphemistically described as “awkward”. At that time the dynamic conjunction operator ; was already widely known and it was certainly known to the authors. The failure to make use of ; in [Kamp and Reyle1993] was based on a certain confusion: In DRSs the need for conjunction as a logical operator is rendered superfluous by the device of collecting DRS conditions into sets – the set Con_K consisting of the DRS conditions of the DRS *K* acts as the conjunction of those conditions. But sets are by definition unordered, so the left-right ordering between the conjuncts of a conjunction in natural language is lost as soon as those conjuncts, or their representations, are made into a set. The indexing system of [Kamp and Reyle1993] was designed to retain information about their order as long as it was needed, but the solution seems ad hoc and is unappealing.

The two-stage architecture adopted here gives us the right way of having our cake and eating it. As indicated by our discussion of (174.a), we need the order within the preliminary representations, but once presupposition justification has taken place, it can be discarded. In the present formulation, it is principle (180) which does the discarding.

- b. A man who also loves a woman who loves him ought to be happy.

(184.a) can only be interpreted as a statement about men who love a women who love some man or other, and presumably one that is different from themselves. And (184.b) implies that there is something else connected with the man (some other property, or something he does) besides loving a woman who also loves him; the parallel between x loves y and y loves x doesn't help in this case to justify the presence of *also*. If we want to capture these asymmetries with the help of $;$, then the component DRSs of the restrictor of the generic quantification in (183) will have to be separated by $;$ at least to the extend shown in (185).⁵⁰

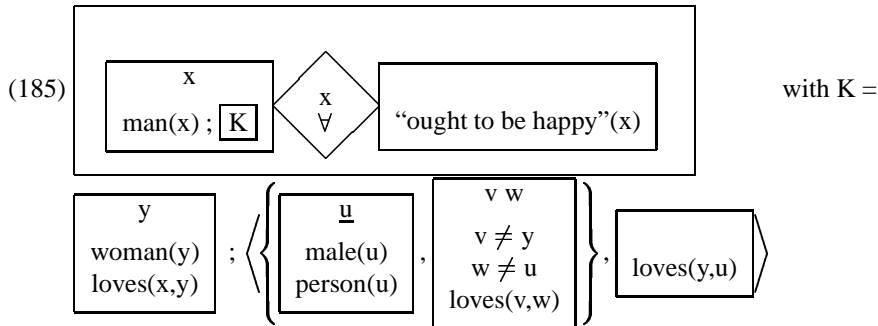

We leave it as an exercise to verify (i) that the two presuppositions of (185) can be resolved in the intended ways on the assumption that what comes to the left of $;$ can serve as context for what occurs to the right, and (ii) that the intended resolutions are blocked in similarly constructed preliminary DRSs for (184a,b).

For relative clause constructions the construction principle yields the $;$ -articulated representations we want. But the asymmetry problem is much more pervasive. (??) gives two further examples.

- (186) a. A little boy loved his rabbit.
 b. When a bishop meets another bishop, he blesses him.

In (??).a switching the order of the two NPs destroys the possibility of interpreting *his* as anaphoric to *a little boy* (whether or not we keep the verb in the active, as in *His rabbit loved a little boy.*, or turn it into the passive, as in *His rabbit was loved by a little boy.*) Similarly switching subject and object in (??).b – *When another bishop meets a bishop he blesses him.* – it becomes much harder (if perhaps not outright impossible) to interpret *another* as anaphorically related to the object

⁵⁰The representation of the *also*-presupposition is based on the assumption that the presupposition *also* generates is similar to the one expressed by *also*'s adjunction site. For this particular case we have assumed that such a proposition can take the form of a combination of the same relation, "love", with different arguments. A proper treatment of the presuppositions triggered by *also* requires an account of information structure which has not been included in this chapter; so the present treatment of the *also*-presupposition has to be taken at face value.

NP *a bishop* (i.e. as understanding the latter NP as denoting an individual from which that of the NP *another bishop* is disjoint). Rather, the new sentence suggests that some bishop is already part of the discourse context.

These last two examples illustrate two points: (i) apparently the asymmetry conditions which limit the possibilities for presupposition resolution are not the same for presuppositions of different types. (The constraint on *his* seems to be stricter than that on *another.*); (ii) the conditions seem to depend on subtle questions of grammatical structure. For the special case of anaphoric pronouns this problem has been thoroughly investigated within the so-called Binding Theory of Government and Binding and subsequent frameworks of Chomskyan or Chomsky-inspired syntax.⁵¹ For anaphoric presuppositions of other kinds and for non-anaphoric presuppositions (for the distinction between anaphoric and non-anaphoric presuppositions as we here understand it, see Section 4.2) the issue is, as far as we know still largely unexplored. As long as the empirical facts in this area remain in the dark there is no hope of stating the principles which guarantee that preliminary representations receive the correct ;-articulation. But, equally important, if the asymmetry constraints on presupposition resolution vary from one type of presupposition to the next, ;-articulation cannot be a sufficient guideline to presupposition resolution in any case. At least for some kinds of presuppositions the relevant structural constraints will have to be represented or defined in some other way. At the present point in time the range of questions that need to be answered in this domain is only gradually coming into sharper view. All we can do here is to point somewhat loosely in this general direction.

4.3 *Syntax and Semantics of Preliminary Representations*

The examples we have shown in Section 4.2 should have given some impressions of the form that preliminary sentence representations can take, but this impression is inevitably incomplete. The formal definition we present in this section of the syntax of preliminary representations is quite liberal. It specifies a class of preliminary representations which includes not only the types exemplified in the last section, but much else besides. For all that is known to us at this point, the class may well be in excess of what it needs to be from the perspective of the semantics of a natural language. But this is an issue that it will be possible to settle only when the present proposal has been applied to a much larger range of cases than it has been so far.

We assume a DRS language L as given. DRS_L denotes the set of all DRSs of L . Exactly what L is like won't matter to the definitions which follow. We have by now come across quite a number of DRS-languages: the "basic" language used in Section 2 and formally defined in Sections 3.1 and 3.2, and the extensions that were introduced in Sections 3.3 – 3.5. Since the extensions proposed

⁵¹See, e.g., [?], [?] and [?]. For a proposal how the Binding Theory of GB can be integrated into a method of constructing DRSs see [?].

in 3.3, 3.4 and 3.5 are independent of each other, this already gives us a range of 7 possible extensions of the basic language. But in fact this is an underestimate since the extensions proposed in 3.3 and 3.5 were not uniquely determined; rather, each can take one of a number of different forms, depending of the adopted set of quantifiers in the case of 3.3 or, in the case of 3.5, depending on the set of aspectual operators, and on the set of adverbial temporal quantifiers. The formal definitions which will follow should be independent of which of the possible DRS languages we choose for our underlying language L . To this end we assume that L is equipped with a certain set OP_L of “complex condition formers” – operators O^n – which build complex DRS conditions from n -place sequences of “argument” DRSs, while binding one or more discourse referents in the process (in the sense in which a quantifier like \forall binds the discourse referent appearing in the central diamond of the corresponding duplex condition). We will assume for simplicity that no operator binds more than one discourse referent at a time (thus leaving the cases of polyadic quantification discussed at the end of Section 3.3 out of consideration). On this assumption it is possible to distinguish between the “variable binding” and the “non-variable binding” operators in terms of a binary feature: we mark each variable binding operator with a “+”, writing O^n_+ , while leaving the non-variable binding ones unmarked. We restrict the scope of the possible languages L in other ways as well, in that we ignore operators like *PROG*, which apply to intensional event abstracts over DRSs, as well as predicates like the attitudinal state predicate ‘Att’ of the next section whose second argument is an ADS (Attitude Description Set), an expression type of a complexity not yet encountered. Again these restrictions are not essential and are easily removed once the definitions are in place for the more restricted set of languages we will consider. We need one further piece of information about our operators, viz. the accessibility relation among their arguments. This is something that cannot be predicted in general terms – recall the difference between \Rightarrow and \vee , with the first argument being accessible from the second (but not vice versa) in the case of \Rightarrow , but with no accessibility either way in the case of \vee . Since we take the accessibility relation within a preliminary DRS K to be a strict partial order (i.e. a relation which is transitive and asymmetric)⁵² and since it will contain the accessibility relations between the components of a DRS condition $O^n(K_1, \dots, K_n)$ as a suborder in case K contains this condition, the accessibility relation among K_1, \dots, K_n will have to be a strict partial order as well. We assume that the accessibility relation among the arguments of any operator $O^n_{(+)} \in OP_L$ is given as part of OP_L , and assume that this information is given in the form of a function *Acc* on OP_L which assigns to each $O^n_{(+)} \in OP_L$ a strict partial

⁵²We assume (i) that presupposition resolution always takes place in a context which does not include information provided by the part of the sentence which contains the presupposition trigger, and (ii) that all information that is accessible from a given constituent of a preliminary representation can be used for justification of the presuppositions adjoined to that constituent. Thus the accessibility relation we need here should be asymmetric and transitive. This is a difference with the original accessibility of DRT, as defined in [Kamp1981a] or [Kamp and Reyle1993] which is transitive, antisymmetric and reflexive.

order on the set $\{1, \dots, n\}$. for operators $O_{(+)}^n$ with more than two arguments we need to make two further assumptions relating to their local accessibility relation, Acc_{O^n} . First, in order that the definitions below are well behaved it is necessary to assume that for each argument K_j of a condition $O^n(K_1, \dots, K_n)$ from which at least one other argument K_i of the condition is accessible, there exists a “nearest accessible” argument.

(187) Suppose that $\langle i, j \rangle \in Acc_{O^n}$, then there must be among the argument positions $1, \dots, n$ one position k which is a “minimal predecessor of j in Acc_{O^n} ”, i.e. $\langle k, j \rangle \in Acc_{O^n}$ and for all m such that $\langle m, j \rangle \in Acc_{O^n}$, $\langle m, k \rangle \in Acc_{O^n}$.

This assumption is needed to guarantee a coherent definition of the *local context* of a presupposition within a preliminary representation. The relevance of the constraint can be seen when we define the accessibility relation Acc_K between the sub-DRSs of a given DRS of L . We can define this relation as the transitive closure of the union of the following sets:

- (a) the set of all pairs $\langle K', K_i \rangle$, where K_i is the i -th argument of a condition of the form $O^n(K_1, \dots, K_n)$ belonging to the condition set of K' , and
- (b) the set of all pairs $\langle K_i, K_j \rangle$, where K_i and K_j are the i -th and j -th arguments, respectively, of a condition of the form $O^n(K_1, \dots, K_n)$ occurring somewhere in K and $\langle i, j \rangle \in Acc_{O^n}$.

(187) is easily seen to ensure that for each K' occurring in K there is a “nearest” sub-DRS K'' of K such that $\langle K'', K' \rangle$. The second assumption only concerns the variable binding operators. For these we assume that the discourse referent bound by the operator is accessible to each of the operator’s arguments. More formally, suppose we write the DRS conditions formed with the help of such an operator as “ $O_x^n(K_1, \dots, K_n)$ ”, then x is accessible from each of K_1, \dots, K_n . We can express this condition in the form of a relation between DRSs, viz. by assuming that each

variable binding operator O^n has an extra DRS argument of the form $K_0 = \boxed{x}$,

where x is the discourse referent bound by the operator, and that the accessibility relation determined by O^n includes all pairs $\langle 0, i \rangle$ (where $i = 1, \dots, n$).

It is clearly in the spirit of our general approach that the transition form DRSs to preliminary DRSs should be defined in this general way, as pertaining to any one of a large number of possible choices for L . However, some of the definitions, which are quite complex, and in our judgment are all the more difficult to understand in the abstract setting which includes an open ended class of underlying DRS languages L which are only required to obey a number of very general constraints. We therefore recommend that the reader, while he is making his way through these definitions for the first time, keeps a particular comparatively simple DRS language L_0 in the back of his head, where the condition forming

operators are \neg , \Rightarrow , \forall and $;$, and where atomic conditions are of the forms $x=y$ or $P(x_1, \dots, x_n)$. For the operator set $OP_{L_0} (= \{\neg, \Rightarrow, \forall, ;\})$ the relevant information is familiar: \forall is the only variable binding operator among them, all but \neg are 2-place, while \neg is 1-place; for \Rightarrow and $;$ the accessibility order is $\{\langle 1, 2 \rangle\}$ (where for \Rightarrow 1 is the restrictor and 2 the nuclear scope and for $;$ 1 is the first conjunct and 2 the second). For \forall the accessibility relation is $\{\langle 0, 1 \rangle, \langle 0, 2 \rangle, \langle 1, 2 \rangle\}$, where 1 indicates the restrictor, 2 the nuclear scope and 0 the “dummy DRS” containing only the bound variable (recall the convention about the accessibility relation of bound variable operators introduced above). For the 1-place operator \neg the local accessibility relation is of course \cdot . Clearly this characterisation of $Acc_{\{\neg, \Rightarrow, \forall, ;\}}$ is in accordance with the constraints imposed above.

Before we proceed with the formal specifications of the various syntactic notions which we will need, a few things ought to be said about the semantics of the representation formalism we are about to define. We are facing a fundamental question here: What should we expect from a semantics for such a formalism? Different answers to this question may be possible, and different answers may be wanted on the basis of one’s general view of the nature of presupposition. From our own perspective, which has informed most of what has been said in this section so far, the following answer seems adequate, and perhaps that by now the reader expected as much: The “semantics” of a preliminary representation should answer the two basic questions which are connected with it within a presupposition theory of the general form we have been advocating:

- (i) there must be a precise model-theoretic answer to the question whether the presuppositions of the preliminary representation are verified given a global context DRS K_g ; and
- (ii) there must be a model-theoretic definition of whether that which remains of a preliminary representation after all its presuppositions have been justified and eliminated is true.

The second of these questions is unproblematic as long as what remains of a preliminary representation after elimination of its presuppositions is a DRS of the underlying DRS language L . For in that case this question reduces to the semantics for L , and we may assume that that has been dealt with as part of the specification of L . This is what we would expect on intuitive grounds, and indeed found to be the case in all the examples we have so far considered. And as a matter of fact, it will follow from the formal definitions below that this will always be so.

What remains is the first question. At first sight this question appears daunting, because, as we have seen, the structure of preliminary representations can be very complex: Presuppositional components of a preliminary representation may have further presuppositions adjoined to them, and so on arbitrarily far down; and presuppositions can occur in the local contexts created by the operators O^n , i.e. as adjuncts to the DRSs which occur as arguments to those operators. And of course these two sources of complexity will often combine (for instance when a

possessive NP such as *his rabbit* occurs within the consequent of a conditional. Presuppositions in the subordinate positions created by operators may look like they present a particularly serious problem, for in general justification of such a presupposition isn't with respect to the global context K_g as such, but with respect to the local context of the presupposition, which combines the information from K_g with information that is sentence-internal.

Nevertheless, it turns out that for the formalisms we will define question (i) has a simple solution too, which relies entirely on the model theory for the underlying language L , which is assumed to be already in place. The reason for this can be explained as follows. For any presuppositional component K' occurring somewhere in a preliminary representation K we can, given a global context K_g , define the total information available for its justification at its local context in K . Moreover, this total information at K' 's local context has the form of a DRS $K_{lc(K')}$. So the question whether K' is justified given KC reduces to the question whether $DRS_{lc(K')} K'$ and this a question about entailment between two DRSs form L .

To determine the local context of K' in K we amalgamate all the non-presuppositional parts of K which we encounter when following the "projection line" defined by the accessibility relation starting from the position of K' 's local context all the way up to the global context K_g . Here we only collect the non-presuppositional parts, while ignoring the presuppositions. This may seem suspicious. For a presupposition such as K' may itself depend on other presuppositions that occur as constituents of K , for instance presuppositions that are directly left-adjointed to K' itself. Is there anything that can be meaningfully said about the justification of K' , one might ask, when the justification of these other presuppositions has not yet been settled?

The answer to this question is as follows. The relation between K_g and K' which concerns us is whether all of K' 's presuppositions are justified in their respective contexts. If that is so, it will be true in particular for those presuppositional components in K which do not presuppose other such components in K . This means that the information they represent is entailed by their local context (and thus by K_g together with the relevant non-presuppositional parts of K). So the question whether presuppositional components of K which depend only on presuppositions of the first ("independent") sort are justified, won't be affected by whether their presuppositions are ignored; for the information that those presuppositions represent will be part of the ontexual information in any case. And so on.

In other words, the analysis of presupposition justification we have alluded to will lead to intuitively correct answers to the question whether all presuppositions of K are justified. As soon as one presupposition is not satisfied in its local context, then our analysis can not be relied upon to give us meaningful assessments of the justification of other presuppositions of K , which depend on it. But in that case we already have a negative answer to our question in any case.

As we have seen, justification in the global discourse context of all presuppositions of the preliminary representation of a sentence is not something that can be expected. More often than not some form of accommodation will be needed. In

such cases the justification analysis we have sketched will return a negative answer, but as things stand it will not tell us what accommodations should be made to turn the global context into one which does justify all presuppositions at once. All that the theory gives us in such cases is a criterium that decides which accommodations will be formally adequate in the sense that the resulting context does justify all presuppositions. We think it is a legitimate suspicion that this cannot be the complete story. For there are many cases where the presuppositions of a sentence that is used in a given context seem to force accommodation of a very specific kind, so much so that the accommodations feel almost like regular inferences which the discourse enables us to draw. We will see an example of this in the next subsection. For the phenomenon of “forced accommodation”, where the sentence and its given context compell us to accommodate in one very specific way no explanation is given by the theory presented here.

When we argued that the entailment relation between DRSs of L is all we need to answer the question whether K_g justifies all presuppositions of K we implicitly assumed that all presuppositions were non-anaphoric. As soon as anaphoric presuppositions come into play, matters get somewhat more complicated because the non-presuppositional parts of K may now have occurrences of discourse referents which are bound within an anaphoric presupposition on which the part depends. However, even this is not a real stumbling block. For justification of an anaphoric presupposition will involve linking its anaphoric discourse referents to some other discourse referent and this “antecedent” discourse referent will have to be declared in (that is, belong to the DRS-universe of) either the global context or else some non-presuppositional part of K. Suppose that there is a link for all the anaphoric discourse referents of K such that all presuppositions of K are justified given that link. Then the presuppositions can be eliminated and at the same time the occurrences of the anaphoric discourse referents in nonpresuppositional parts can be replaced by their antecedents according to the link. In this way we once again obtain from K a DRS from L as definitive representation. This DRS will in general not be proper, but its free discourse referents will be declared in the global context DRS K_g , just as this would be expected on the treatment of transsentential anaphora in classical DRT.

Syntax for Preliminary Representations without Anaphoric Presuppositions

The definition of the set of preliminary representations for L is fairly straightforward except for one complication. This complication is connected with anaphoric presuppositions – those which involve anaphoric discourse referents (marked by underlining in our sample treatments in Section 4.2). We sidestep this complication for the moment by defining, as a first step, the set of preliminary representations in which anaphoric presuppositions do not occur. The definition which includes anaphoric presuppositions will follow in the next subsection. This definition is quite simple: The set PR_L^- of preliminary representations of L without anaphoric presuppositions consists of (i) the DRSs of L, and (ii) pairs of the form $\langle K, K \rangle$,

where K is a preliminary representation and K a set of preliminary representations (intuitively, the set of presuppositions left-adjoined to K). Moreover, complex conditions now come in two forms. On the one hand we want to admit preliminary representations of the form $\langle K, K' \rangle$ where K is a preliminary representation and K a set of such representations; and on the other hand we must allow for complex conditions of the form $O_x^n(K_1, \dots, K_n)$, where K_1, \dots, K_n are preliminary representations. If K is of the form $\langle K, K' \rangle$, then K' may itself be again of such a form, i.e. $\langle K', K'' \rangle$, and so on. In a case like this both K and K' function as presuppositions for K'' . We define the notion of the presupposition set in K of a quasi-DRS K' that is a constituent of K – in symbols: $\text{PRES}(K', K)$ – accordingly.

accessibility

- (i) Suppose that K' is a preliminary DRS that is a constituent of K and which is not part of a larger constituent $\langle K', K'' \rangle$. Then $\text{PRES}(K', K) = \emptyset$.
- (ii) Suppose that $\langle K, K' \rangle$ is a constituent of K . Then $\text{PRES}(K', K) = \text{PRES}(\langle K, K' \rangle, K) \cup K$.

accessibility ! local

accessibility

context ! local

 $\text{PRES}(K', K)$ ATCON_L

As usual V is the set of all discourse referents. ATCON_L is the set of atomic conditions of L .

DEFINITION 0.54. (Of the set PR_L^- of *Preliminary Representations* of L without anaphoric presuppositions, and the set PRCON_L^- of *Conditions* of such Preliminary Representations)

- (i) $\text{PR}_L^- ::= \langle \mathcal{P}(V), \mathcal{P}(\text{PRCON}_L^-) \rangle \mid \langle \mathcal{P}(\text{PR}_L^-), \text{PR}_L^- \rangle$
- (ii) $\text{PRCON}_L^- ::= \text{ATCON}_L \mid O^n(\text{PR}_L^-, \dots, \text{PR}_L^-)$ (with $O^n \in \text{OP}_L$)

($\mathcal{P}(X)$ denotes the power set of X .)

In order to define the semantics for preliminary representations we need a number of notions related to the syntax of PR_L^- . These are defined under 1.-8. below.

1. We can distinguish the members of PR_L^- into two types, those preliminary representations which are of the form $\langle K, K' \rangle$ and those which are not. The latter will be called *quasi-DRSs*. (They are like DRSs in that they consist of a set of discourse referents and a set of conditions, except that the conditions need not be DRS-conditions in the strict sense of the word but can be preliminary conditions of any kind.)

2. When $K \in \text{PR}_L^-$ is of the form $\langle K, K' \rangle$, K' is called the *head* of K and K the *presupposition set* of K .

3. Each member K of PR_L^- is either a quasi-DRS or it is formed from a quasi-DRS through possibly repeated adjunction of sets of presuppositions. This quasi-DRS is called the (*non-presuppositional*) *root* of K , and denoted as $\text{root}(K)$. The

DRS condition ! atomic
representation ! preliminary

definition is obvious: If K is a quasi-DRS, then $\text{root}(K) = K$, and if $K = \langle K, K' \rangle$, then $\text{root}(K) = \text{root}(K')$. It follows that among the preliminary representations K' that are part of a preliminary representation K we have: K' is a quasi-DRS iff $\text{root}(K') = K'$.

PRCON ^-_L

4.alt Suppose that K' is part of a preliminary representation K (either a proper part or K itself) and that K' is a quasi-DRS. Then the *presuppositions of K' in K* , $\text{PRES}(K', K)$, are all those which have been added to K' through successive left-adjunction. We define $\text{PRES}(K', K)$ via the auxiliary notion of a preliminary representation K'' being an Adjunction Expansion of K' in K , $\text{ADEX}(K'', K', K)$. Let $\text{IMADEX}(K)$ be the relation of immediate adjunction in K , i.e. $\langle K'', K' \rangle \in \text{IMADEX}(K)$ iff K', K'' are parts of K and there is a subset K of PR^-_L such that $K'' \in \langle K, K' \rangle$. Then $\text{ADEX}(K'', K', K)$ iff there is a finite chain $K_1 = K', \dots, K_m = K''$, of length $m \geq 1$, such that for $i = 1, \dots, m-1$, $\langle K_{i+1}, K_i \rangle \in \text{IMADEX}(K)$. (Note that this entails that always $\text{ADEX}(K', K', K)$.) $\text{PRES}(K', K)$ is defined in terms of ADEX as follows:

PR ^-_L
DRS ! quasi-
root
head
presupposition

$\text{PRES}(K', K) = \text{def. } \{K'' : \text{there are preliminary representations } K_i, K_{i+1} \text{ that are constituents of } K \text{ and } K \subseteq \text{PR}^-_L \text{ such that } \text{ADEX}(K_i, K', K), K_{i+1} = \langle K, K_i \rangle \text{ and } K'' \in K\}$

4. Given a preliminary DRS K we can consider the set of all constituents of K which are presuppositions of some quasi-DRS K' that is a constituent of K . We call this set the set of *presuppositions occurring in K* , $\text{PRES}(K)$:

PRES(K', K)

$\text{PRES}(K) = \{K'' \mid \exists K' (K' \text{ is a constituent of } K \text{ and } K'' \in \text{PRES}(K', K))\}$

5. Def.1 assigns to each member E of $\text{PR}^-_L \cup \text{PRCON}^-_L$ a unique parse. We can think of the parse as a decorated tree T_E , in which each node is decorated by either (i) a member of PR^-_L , (ii) a subset of PR^-_L , or (iii) a member of PRCON^-_L . Moreover, the edges of T_E are of the following types: \in , *pres*, *head* and $\text{Arg}_i(O^n)$, where $O^n \in \text{OP}_L$ and $i \leq n$. Each edge connects a mother node with one of its daughters. We have an \in -edge when either (a) the decoration of the mother node is a set of members of PR^-_L and the decoration of the daughter node is a member of that set or (b) the decoration of the mother node is a quasi-DRS and the decoration of the daughter node is one of its conditions. *pres*-edges connect a mother node decorated with a member of PR^-_L of the form $\langle K, K \rangle$ with the daughter node that is decorated with the presupposition set K of that member; and *root*-edges connect mother nodes decorated with $\langle K, K \rangle$ with the daughter node decorated with the root K . Finally, an $\text{Arg}_i(O^n)$ -edge connects a mother node decorated with a preliminary condition of the form $O^n(K_1, \dots, K_n)$ with the daughter node decorated with the i -th argument K_i .

adjunction ! expansion
ADEX(K'', K', K)

Note that in the parse trees described here the discourse referents occurring in preliminary representations are ignored.

adjunction ! emmediate
PRES(K)

6. Each preliminary representation K can be reduced to a DRS $\text{PRESRED}(K)$, the *presupposition reduction* of K , by eliminating all presuppositions from it. The procedure for obtaining $\text{PRESRED}(K)$ from K may be obvious in any case, but here is a formal definition:

DEFINITION 0.55.

- (i) $\text{PRESRED}(\langle K, K \rangle) = \text{PRESRED}(K)$;
- (ii) for a quasi-DRS K , $\text{PRESRED}(K) = \langle U_K, \{\text{PRESRED}(\gamma) : \gamma \in \text{Con}_K\} \rangle$;
- (iii) for γ an atomic condition of L : $\text{PRESRED}(\gamma) = \gamma$
- (iv) for $O_{(x)}^n(K_1, \dots, K_n) \in \text{PRCON}_L^-$, $\text{PRESRED}(\gamma) = O_{(x)}^n(\text{PRESRED}(K_1), \dots, \text{PRESRED}(K_n))$.

7. Let $K \in \text{PR}_L^-$ and let γ be an atomic condition occurring somewhere in K . Then there will be at least one preliminary representation K' that is a constituent of K such that $\gamma \in \text{PRESRED}(K')$.

The fact mentioned in 7. is the key to the definition of what it means for a preliminary representation K from PR_L^- to count as *proper*, i.e. for all the discourse referents occurring in it to be properly bound. An occurrence of a discourse referent x in some atomic condition γ which occurs somewhere in K is *bound in* K if there exists a preliminary representation K' that is part of K such that $\gamma \in \text{PRESRED}(K')$ and either $x \in U_{K'}$ or there is a K'' in $\text{PRESRED}(K)$ which is accessible from K' such that $x \in U_{K''}$.

tree ! decorated

DEFINITION 0.56. Let $K \in \text{PR}_L^-$. K is *proper* iff for each occurrence of a discourse referent x in some atomic condition γ occurring in K there exists a $K' \in \text{PR}_L^-$ such that K' is a constituent of K , $\gamma \in \text{PRESRED}(K')$ and $x \in U_{K'}$.

8. Among the preliminary representations which are constituents of a given preliminary representation K , some can play a role of local context in presupposition justification. These are (i) the root of K and (ii) the root of every complex condition K, K' in K , and (iii) the roots of the arguments K_i of a complex condition $O_{(x)}^n(K_1, \dots, K_n)$ in K . We refer to this set as the set of *potential local contexts in* K and denote it as $\text{PLC}(K)$.

T_E

presupposition ! reduction

All preliminary representations that are part of K and that are not in $\text{NPRP}(K)$ are among K 's presuppositions or are part of some presupposition. We will refer to them as the *Presuppositional Representations* in K , $\text{PRESR}(K)$.

PRESRED(K)

Syntax of Preliminary Representations with Anaphoric Presuppositions

DRS ! proper

The notion of an “anaphoric presupposition”, in the sense in which it was used in

Section 4.2, involves that of “anaphoric” discourse referents, discourse referents which must, as part of the presupposition’s justification, find antecedents in some accessible context. In the examples of anaphoric presuppositions we have seen there was never more than one anaphoric discourse referent per anaphoric presupposition, but this is a restriction that we cannot expect to hold generally. So we want to allow for arbitrary sets of anaphoric discourse referents. In other words, the set of anaphoric discourse referents will in general be some subset of the main Universe U of such a presupposition representation. We allow any subset between \emptyset and U inclusive, the case of being the non-anaphoric – or “purely propositional” – presuppositions being that where the set = \emptyset .

context ! local ! potential

PLC(K)

PRESR(K)

The simplest way to formalise this notion of an anaphoric presupposition representation is to replace in our definitions of PR_L and $PRCON_L$ the DRS universes U everywhere by pairs $\langle U, A \rangle$, with $A \subseteq U$. A is the set of anaphoric discourse referents of the given representation with “universe” $\langle U, A \rangle$.

A slight further complication is that anaphoric discourse referents have no business in the non-presuppositional parts of representations. That is, if $\langle \langle U, A \rangle, \text{Con} \rangle \in \text{PLC}(K)$ for some K , then A should be \emptyset . We denote the set of preliminary representations K for which this condition holds as PR'_L . This more restricted set also is now the resource from which complex conditions are built. The need to distinguish between PR_L and PR'_L entails that we now need a definition by simultaneous recursion of the three sets PR_L , PR'_L and $PRCON_L$. It is convenient in this connection to deviate a little more from the strict Backus-Naur format than we did in Def. 0.54.

DEFINITION 0.57. (Of the set PR_L of *Preliminary Representations* of L with anaphoric presuppositions, and the set $PRCON_L$ of *Conditions* of such Preliminary Representations)

$$PR_L ::= \langle \langle U, A \rangle, \mathcal{P}(PRCON_L) \rangle, \text{ where } U \in \mathcal{P}(V) \text{ and } A \subseteq U \\ | \langle \mathcal{P}(PR_L), PR_L \rangle$$

presupposition ! anaphoric

$$PR'_L ::= \langle \langle U, \emptyset \rangle, \mathcal{P}(PRCON_L) \rangle, \text{ where } U \in \mathcal{P}(V) \\ | \langle \mathcal{P}(PR_L), PR'_L \rangle$$

$$PRCON_L ::= \text{ATCON}_L | O^n(PR'_L, \dots, PR'_L) \text{ (with } O^n \in OP_L)$$

discourse referent ! anaphoric

N.B. there is a one-one correspondance between the preliminary representations given in Def. 0.54 and those preliminary representations in the sense of Def. 0.57 in which all universes are of the form $\langle U, \emptyset \rangle$. Let us denote the subset of these preliminary representations in the sense of Def. 0.57 which correspond in this way to members of PR_L^- as PR_L^{-1} . Then we evidently have $PR_L^{-1} \subset PR'_L \subset PR_L$.

All notions defined in the last section for members of PR_L^- generalise straightforwardly to the sets PR_L and PR'_L . In particular, every member of PR_L has a unique parse, which can be represented by a parse tree of the same form as defined on page 167. The only exception is the notion of a proper representation. This notion requires renewed attention because the anaphoric presuppositions create situations in which an occurrence of a discourse referent x in some atomic condition belonging to a part representation K' is bound by the occurrence of x in the

universe of some presupposition of K' . We have seen several instances of this in Section 4.2. For example, in (153) the occurrence of u in the condition “white(u)” of the non-presuppositional part of the representation is bound by the occurrence of \underline{u} in the universe of the presupposition left-adjoined to this part.

We will assume that presuppositional binding of discourse referents is always of this comparatively simple form: If an occurrence of x in some atomic condition belonging to some quasi-DRS K' in a preliminary representation is bound presuppositionally, then this can be only through the presence of x in the set A of anaphoric discourse referents of a preliminary representation in $\text{PRES}(K',K)$. (This entails in particular that if x is any non-anaphoric discourse referent belonging to the universe of a presupposition K'' of K' (i.e. if this universe is $\langle U,A \rangle$, then $x \in U \setminus A$), then x will not occur in atomic conditions belonging to K' . For an illustration, see the discourse referent x for the possessive pronoun *his* in (150).)

These assumptions lead us to the notion of the extended universe of a quasi-DRS K' belonging to some preliminary representation K . We denote this set as $\text{EU}(K',K)$, and sometimes, when it is clear which K is at issue, as $\text{EU}_{K'}$. $\text{EU}(K',K)$ consists of the universe of K' itself together with the sets of anaphoric discourse referents of all members of the presupposition set of K' in K . In other words:

$$\text{EU}(K',K) = U_{K'} \cup \bigcup \{A: (\exists K'', U, \text{Con})(K'' \in \text{PRES}(K',K) \ \& \ K'' = \langle \langle U,A \rangle, \text{Con} \rangle)\}$$

$\text{EU}_{K'}$ replaces $U_{K'}$ in a couple of the auxiliary notions introduced above. First, the definition of the reduction PRESRED now has to be modified in that if K' is a quasi-DRS, then

$$\text{PRESRED}(K') = \langle \text{EU}_{K'}, \{\text{PRESRED}(\gamma) : \gamma \in \text{Con}_{K'}\} \rangle.$$

(This renders the definition on the larger preliminary representation K of which K' is considered a part, so that PRESRED now becomes dependent on this second parameter as well. Thus, strictly speaking the definition is now of a 2-place function $\text{PRESRED}(K',K)$. But we will persist with the earlier notation and only mention the argument K' . Secondly, need to adapt the definition of what it is for a preliminary representation to be proper.

DEFINITION 0.58. Let $K \in \text{PR}_L$. K is *proper* iff for each occurrence of a discourse referent x in some atomic condition γ occurring in K there exists a $K' \in \text{PR}_L$ such that K' is a constituent of K , $\gamma \in \text{PRESRED}(K')$ and $x \in \text{EU}_{K'}$.

Local Contexts

Suppose that K is a member of PR_L and that K' is a presupposition occurring in K , i.e. $K' \in \text{PRES}(K)$. Justification of K' takes place in the *local context* of K' in K whenever possible, and only if K' has no local context in K in the *global context*. The local context of K is intuitively the first quasi-DRS K'' in K (if any) which one encounters going up the parse tree T_K of K , starting from K' . If such a quasi-DRS

K'' is reached, this will always mean that the last edge of the path running from K' to K'' is an \in -edge and that if m and d are the mother node and daughter node this edge connects, then the decoration of d is a condition belonging to the condition set of the duration of m . There then are two possibilities: (i) the condition at d is of the form $\langle K, K''' \rangle$ with $K \in \mathcal{P}(\text{PR}_L)$, $K''' \in \text{PR}_L$; (ii) the condition is of the form $O_{(x)}^n(K_1, \dots, K_n)$. In the first case K'' is the local context of K' in K . The second case is a little more complicated. In this case the node will itself be the mother node of an $\text{Arg}_i(O^n)$ -edge along the given path, and the corresponding daughter d' will be decorated with K_i . If there is a j such that $\langle j, i \rangle \in \text{Acc}_{O^n}$ then the local context of K' will be the root of that K_h ($h \neq i$, $h \leq n$) such that $\langle h, i \rangle \in \text{Acc}_{O^n}$ and for all j such that $\langle j, i \rangle \in \text{Acc}_{O^n}$ $\langle j, h \rangle \in \text{Acc}_{O^n}$. (I.e. the root of K_h which is the nearest to K of the arguments of O^n which are accessible from K_i .) If for no $j \leq n$ $\langle j, i \rangle \in \text{Acc}_{O^n}$, then the local context of K_i is K'' .

We can define this notion of local context formally on the basis of a notion of accessibility for preliminary representations which we define first.

PRESRED

DEFINITION 0.59. Let K be a preliminary representation, then the *accessibility relation on K* , Acc_K , is the set of all pairs $\langle K'', K' \rangle$, where K'' and K' are constituents of K , K' is a preliminary representation and K'' is a quasi-DRS, is defined as the transitive closure of the relation Acc_K^0 . Acc_K^0 consists (i) of all pairs $\langle \text{root}(K_j), K_i \rangle$ such that $O_{(x)}^n(K_1, \dots, K_n)$ occurs in K and $\langle j, i \rangle \in \text{Acc}_{O^n}$; and (ii) of all pairs $\langle K'', K' \rangle$ satisfying the following condition:

proper

- (a) (which is close to the one already informally described)

K' is a preliminary representation that is a constituent of K and K'' is determined as follows: go up through the construction tree T_K of K , starting from K' . K'' is the decoration of the first node along this path whose decoration is a quasi-DRS.

Like the accessibility relation between sub-DRSs of a given DRS, Acc_K is a strict partial order. Furthermore it is not hard to verify that if $K' \in \text{Ran}(\text{Acc}_K)$ (i.e. there are “sentence-internal” contexts of K'), then there is a “nearest” such K'' , i.e. $\langle K'', K' \rangle \in \text{Acc}_K$ and for all $\langle K''', K' \rangle \in \text{Acc}_K$ either $K''' = K''$ or $\langle K''', K'' \rangle \in \text{Acc}_K$. And, finally, whenever $\langle K'', K' \rangle \in \text{Acc}_K$, then K'' is a quasi-DRS and $K'' \in \text{PLC}(K)$.

We are now in a position to define the local context of a presuppositional component K' of a preliminary representation K . There are in fact three related but distinct notions of local context that we will need. The first is the one which we have informally described already: The local context of K' in K in this sense is that K'' in $\text{PLC}(K)$ which is nearest to K' in the sense of Acc_K (provided any such K'' exists; if not, then K' doesn't have a local context). We represent this notion of local context in the form of a 3-place relation between K , K' and its local context K'' and denote the relation as “ $\text{LocConK}(K'', K', K)$ ”.

context ! local

The second notion is that of the *Sentence-Internal Information available for presupposition justification at the local context of K' in K* , which we denote as $SILC(K',K)$. Intuitively $SILC(K',K)$ consists of the totality of presupposition-free information that is available at all “sentence-internal” contexts accessible from K' , i.e. all quasi-DRSs K'' such that $\langle K'',K' \rangle \in Acc_K$. All local contexts, we saw, are quasi-DRSs. But what is the “presupposition-free” information of a quasi-DRS? The definition is pretty much as the term suggests: the *presupposition-free information* of a quasi-DRS K'' consists of the discourse referents of K'' together with those conditions which contain no presuppositions, and thus are DRS-conditions of the language L .

Let K be a quasi-DRS from PR_L , then
 $PF(K) = \langle U_K, \{ \gamma \in Con_K : \gamma \in CON_L \} \rangle$

We can now define $SILC(K',K)$ as the merge of all the DRSs $PF(K'')$ for $\langle K'',K' \rangle \in Acc_K$.

DEFINITION 0.60. Let K''' be a preliminary representation that is a constituent of a preliminary representation K . Then
 $SILC(K',K) = \uplus \{ PF(K'') : \langle K'',K' \rangle \in Acc_K \}$.

(Here \uplus represents the merge of a set of DRSs. See the end of Section 3.2.)

NB. In case K' has no local context in K , then the argument set of \uplus in the definition above is empty and $SILC(K',K) = \uplus \emptyset = \langle \emptyset, \emptyset \rangle$ (the empty DRS).

The third notion of local context is very close to the second. This is the *total information available for presupposition justification at the local context of K' in K* , $TILC(K',K)$. $TILC(K',K)$ is the merge of $SILC(K',K)$ with the global context DRS K_g .

Def. 0.61 repeats the definitions of the three notions.

DEFINITION 0.61. (Local Context of K' in K ; *Total Information Available at the Local Context of K' in K* ; and *Sentence-Internal Information available at the Local Context of K' in K*)

Let K be a preliminary representation and K_g a DRS. (Intuitively, K_g represents the context in which the sentence represented by K is uttered.) Let K', K'' be preliminary representations that are constituents of K .

- (i) $LocCon_K(K'',K',K)$ iff
 - (a) $\langle K'',K' \rangle \in Acc_K$ and
 - (b) for all K''' such that $\langle K''',K' \rangle \in Acc_K$, $\langle K''',K'' \rangle \in Acc_K$.
- (ii) $SILC(K',K) = \uplus \{ PF(K'') : \langle K'',K' \rangle \in Acc_K \}$
- (iii) $TILC(K',K,K_g) = SILC(K') \cup K_g$

The point of these different notions is as follows. Assume that $K' \in \text{PRES}(K)$. The local context K'' of K' in K is intuitively the lowest point in the logical structure of K where justification of the presupposition K' is possible. We assume that a presupposition is always justified at this lowest possible point. In other words – this is one respect in which the present proposal differs from other DRT-based accounts:

(188) Presupposition justification always takes place at the local context.

SILC(K')

However, the contextual information that is available for justification of K' at its local context K'' includes not only the information contained in K'' itself but also that contained in all K''' in K which are accessible from K'' (and thus from K') as well as that of the global context K_g . (Thus the more local a context, the more information it makes available.) It follows from this stipulation that if justification of K' can succeed at all, it will succeed at K'' . So the assumption (188) that presuppositions are always justified at their local context isn't shouldn't be seen as an empirical claim. It only reflects a particular perspective on the nature of presupposition justification.

Sometimes justification of K' at its local context K'' is possible on the basis of SILC(K', K) alone. These are the cases which the classical presupposition literature describes as instances of “local satisfaction”, or “local binding”,⁵³ cases where the presupposition, being justifiable without any appeal to K_g , disappears as a presupposition of the full sentence which contains its trigger – in other words, where the presupposition “doesn't project”. It disappears because the constraints it imposes on context are satisfied in any case. Thus, as far as it is concerned, the sentence could be uttered in any global context.

information ! presupposition-free

TILC(K', K)

LocCon $_K(K'', K)$

Semantics for Preliminary Representations

As explained above, the “semantics” of preliminary DRSs as we understand it only concerns the question whether the presuppositions of a preliminary DRS K are justified in a global context K_g . And this question, we already saw, has a positive answer iff for every $K' \in \text{PRES}(K)$ K' is entailed by the total information at its local context. In the case where none of the presuppositions of K are anaphoric this amounts simply to: $\text{TILC}(K', K, K_g) \models K'$ for all $K' \in \text{PRES}(K)$.

That is all that needs to be said for this case. If the answer is positive, then K can be reduced to the DRS $\text{PRESRED}(K)$. The questions of truth and verification for such DRSs are a matter for the semantics of the underlying language L , as is the definition of $\text{TILC}(K', K, K_g) \models K'$. In case K contains anaphoric presuppositions the matter is more complicated. Justification of the presuppositions of K must now be made dependent on a resolution of the anaphoric discourse referents, and we

⁵³Or alternatively, as “intermediate satisfaction” or “binding”. Note that the use we make of “local” corresponds to what others have called “intermediate” (cf. in particular [van der Sandt1992]).

need to spend some care on the definition of what a possible resolution is for the anaphoric discourse referents of K given a global context K_g .

A possible resolution of K (given K_g) must link each anaphoric discourse referent u occurring in K with a possible antecedent x . For x to be a possible antecedent for u , x must (i) accessible from the position of u in the sense familiar from standard DRT, and (ii) x must belong to the universe of a quasi-DRS K'' which qualifies as context from the perspective of the anaphoric presupposition K' which contains u as a member of its universe. Both these requirements are fulfilled if $\langle K'', K' \rangle \in \text{Acc}_K$. Let us make these considerations more explicit. Suppose that $K \in \text{PR}_L$ and that x is a discourse referent which belongs to the set of anaphoric discourse referents $A_{K'}$ for some constituent K' of $\text{PRES}(K)$ (in other words $U_{K'} = \langle U, A \rangle$). The set of potential antecedents for x is then the union of all universes of quasi-DRSs K'' in K such that $\langle K'', K' \rangle \in \text{Acc}_K$ together with the universe of the context DRS K_g . We distinguish between the set $\text{IPA}(x, K)$ of those potential antecedents of x which are “internal to” K , and the total set of potential antecedents, given the context K_g , $\text{PA}(x, K, K_g)$. Formally:

$$\begin{aligned} \text{IPA}(x, K) &= \bigcup \{U_{K''} : \langle K'', K' \rangle \in \text{Acc}_K\} \\ \text{PA}(x, K, K_g) &= \text{IPA}(x, K) \cup U_{K_g} \end{aligned}$$

$\text{IPA}(x, K)$ and $\text{PA}(x, K, K_g)$ enable us to define the notion of a potential resolution of the anaphoric discourse referents of K :

A potential anaphoric resolution for a preliminary representation K belonging to PR_L , given the global context K_g , is a function r from discourse referents to discourse referents whose domain consists of the anaphoric discourse referents occurring in K and which is such that for any such discourse referent x , $r(x) \in \text{PA}(x, K, K_g)$.

We say that r *resolves x sentence-internally* iff $r(x) \in \text{IPA}(x, K)$.

Exactly how the anaphoric discourse referents of a preliminary DRS K should be resolved in a context DRS K_g – i.e. which of the possible resolutions should be chosen – is a problem which classical DRT made it a policy to leave to other theories. We will adopt this policy here too. That is, we consider, given K and K_g , any one of the possible resolutions r for the anaphoric discourse referents of K , given K_g , and then consider whether for each of the presuppositions K' of K $\text{TILC}(K', K, K_g) \models_r K'$ given this choice of r . We abbreviate this relation as $\text{TILC}(K', K, K_g) \models_r K'$. This relation holds provided the discourse referents of K' are always assigned the same values as the discourse referents in $\text{TILC}(K', K, K_g)$ to which r resolves them. In other words, for any DRSs K_1, K_2 $K_1 \models_r K_2$ iff for any model \mathcal{M} , world w of \mathcal{M} and time t of \mathcal{M} r -verification of K_1 within w at t , entails r -verification of K_2 within w at t , where r -verification is defined in the same way as verification except that the embedding functions f involved must all satisfy the following condition:

presupposition ! justification

binding ! local

justification ! local

presupposition ! projection

if $x \in \text{Dom}(r) \cup \text{Dom}(f)$, then $r(x) \in \text{Dom}(f)$ and $f(x) = f(r(x))$.

Suppose we can find a resolution r for K , given K_g , such that all presuppositions are justified by K_g . Then, as for the case where K contains no anaphoric presuppositions K should be reducible to a DRS K' by eliminating all presuppositions from it. We must now take care, however, that when an anaphoric presupposition is removed, and with it an anaphoric discourse referent or discourse referents occurring in its universe, then the occurrences of the anaphoric discourse referents in conditions belonging to the non-presuppositional parts of K , which are not removed should be replaced by their antecedents under r . We obtain the desired result by reducing K first through application of the operator PRESRED and then replacing discourse referents in PRESRED(K) which also occur in $\text{Dom}(r)$ everywhere by their r -values. The result will be a DRS $r(\text{PRESRED}(K))$ which need not be proper, but where free discourse referents will belong to the universe of K_g .

4.4 Accommodation and Inference.

The semantics developed in Section 4.3 tells us when a sentence, uttered in a context K_g and preliminarily represented as K , is true or false in a model. Part of what it tells us is that the sentence will be either true or false only if all its presuppositions are justified. The examples we have looked at in Section 4.2 have given us a taste of how stringent this requirement is. It is normal for a sentence to generate presuppositions, and usually not just one but a whole bunch of them: Joint satisfaction of all those presuppositions is a constraint that it is in general not easy for utterance contexts to meet. This implies that if a speaker wants to make an assertion that is true, he will have to proceed with great caution in general, lest this sentence generate a presupposition that in the given context isn't warranted.

When we see how language is actually used and interpreted, this conclusion appears alarmist. Far fewer utterances seem inappropriate than it predicts. The reason for this discrepancy is that human interpreters are generous accommodators. Many presuppositions are accommodated quasi-automatically by interpreters who don't seem to be aware of the fact that they are doing so. Normally it is only when an accommodation that is needed goes against something that the interpreter believes that he will be conscious of what he is doing – that he is adjusting his assumptions in such a way that the utterance makes sense against their background.

When an accommodation which the interpreter perceives as required is in conflict with what he believes, he may nevertheless make it and revise his beliefs accordingly. But if these beliefs are too amply entrenched – when he is quite certain of them, then he will refuse to make the accommodation, and in such cases, we already stated in the last section, we regard the interpretation process as breaking down: a preliminary representation for the utterance can be constructed, but there is no way (not even one involving accommodation) to integrate it into the context. How easy a presuppositional constraint can be accommodated seems to vary between presuppositions, and in particular as a function of their triggers. Pro-

IPA(α, K)
PA(α, K)

nouns are a notorious case in point (if they are included among the presupposition triggers at all, as we have done here). Factive presuppositions are among the kinds of presuppositions that are accommodated with great ease. If A tells B that Fred is relaxed that his proposal wasn't accepted, and B didn't know that Fred proposed, B will assume this almost as a matter of course. (He will only if he is convinced that Fred didn't propose.) Such presuppositions differ from presuppositions triggered by a word like *too*. An utterance containing *too* (or an equivalent expression such as *also*, *as well* and some others) gives rise to a presupposition that should be justifiable in the context established by the immediately preceding discourse. These "anaphoric" presuppositions (in the sense of "anaphoric" used by Kripke (viz. [?]) which is different from the sense in which we have been using the term) are hard to accommodate because the discourse context is as accessible to the interpreter as it is to the speaker: It is constituted by that what has just been said and that is equally known to both parties.⁵⁴

The distinction between presuppositions that are "anaphoric" in the present sense and those that are not, is only one among a number which we expect a detailed theory of presupposition will have to draw.⁵⁵ And it isn't clear at this point which of these distinctions are binary and which a matter of graduation. The need to draw such distinctions between types of presuppositions exists in particular for a theory like the one sketched here, which is very liberal in what it includes among the range of phenomena to which it applies.

As far as we can see the DR-theoretical bases of the present theory is of little help in telling what these distinctions are, and we have more to say on their account here. There is another issue connected with accommodation, however, where the DRT-approach outlined here does appear to be of use. Often presupposition accommodation strikes us not only as possible, but in fact as necessary. In such cases the accommodation seems to be forced upon the interpreter, and the accommodated information seems more like an inference from the uttered sentence or discourse than like an assumption which the interpreter chooses to make for the sake of restoring coherence.

We present two examples of this phenomenon which have been discussed in

⁵⁴The exception that confirms the rule is where a hearer drops in on an ongoing conversation and the first sentence he hears is one containing *too*. In these circumstances a *too*-presupposition will be readily accommodated, but not only in the sense of being entailed by something that is assumed to be true but as something that was actually *said* in virtue of which the presupposition is justified.

⁵⁵Another distinction has to do with how easily a presupposition is cancellable under negation. Cancellation of the existence presupposition carried by a definite description, while possible, requires genuine effort – you can say *The exhibition wasn't opened by the King of France*. but something like the *because*-clause is indispensable lest the main clause be misunderstood. The matter is different for the pre-state presuppositions of change-of-state verbs. Take for instance the transitive verb *open*. You can open something at a time *t* only when at *t* that thing isn't open yet – y's being closed is a necessary pre-state of an event of opening *y*. And this condition appears to be presuppositional insofar as there is a tendency to interpret negated statements like *He didn't open the window*. as implying that the window was closed at the time in question. Nevertheless when someone asks you: *Did you open the window while I was out of the room?* you can quite legitimately answer with a simple *no* even if as a matter of fact the window had been open all day long.

the literature. In these examples the inferential effect of accommodation seems particularly compelling. One of them, given in (189.b), is a sentence that was first presented by Kripke in a lecture that is often cited, but of which no canonical textual version seems available.⁵⁶

- (189) a. We shouldn't have pizza on John's birthday, if we are going to have pizza on Mary's birthday.
 b. We shouldn't have pizza again on John's birthday, if we are going to have pizza on Mary's birthday.

(189.b) strongly invites the inference that Mary's birthday is before John's birthday. (189.a) does not seem to carry this implication – if at all, then surely much less forcefully than (189.b). The difference can only be the presence in (189.b) of *again*.

What is the explanation of this effect? As we saw in 2.3, occurrences of *again* trigger presuppositions to the effect that an event of the same type as that described in the clause containing the occurrence happened before the described event. In other words, we have the presupposition that at some time before the event of “we” having pizza at John's birthday there was another event of “we” having pizza. In (189.b) this presupposition is generated within the consequent of the conditional, so its local context is the antecedent of the conditional. As it stands, the information contained by the antecedent goes a fair way towards justifying the presupposition, since the antecedent does speak of a pizza eating event with “we” as agent. But it doesn't stretch all the way. What is still missing is the information that the event spoken of in the antecedent temporally precedes the one spoken of in the consequent. Still, the antecedent gets us so close to a justification of the *again*-presupposition that the impression that is meant to be understood as the justification of the presupposition seems virtually inescapable. So the recipient of (189.b), who is uninformed about the dates of the two birthdays, will feel impelled – he will *conclude* – that Mary's birthday comes before John's.

That this “conclusion” is mediated by presupposition justification finds further support in the circumstance that when (189.b) is offered as follow-up to a sentence which talks about yet another pizza eating event the conclusion may be blocked. Thus consider (190)

- (190) We have just had pizza on Billie's birthday. So we shouldn't have pizza again on John's birthday, if we have pizza on Mary's birthday.

In (190) the *again*-presupposition can be justified in the context provided by the first sentence, (Indeed, since the first sentence speaks of such an event in the past and the main clause of the second sentence of one in the future, justification doesn't need accommodation in this case.) Since the presupposition can be justified in this

⁵⁶fn on Kripke's presupposition lecture.

way, there is no need to use the information of the *if*-clause for this purpose, so there is no need to accommodate that Mary's birthday precedes that of John.

presupposition ! cancellation

In our second example the inferential flavour of accommodation is even stronger, and it is hard to see how it could be suspended by providing more context. This example is a three-sentence discourse, given in (191).

(191) I gave the workmen a generous tip. One went out of his way to thank me.
The other one left without saying a word.

Anyone who reads these two lines knows that the number of workmen to whom the speaker gave a generous tip must have been two. How does this knowledge arise? It clearly depends on the subject phrases of the three sentences. The dependence on the subject of the third sentence, for instance, becomes visible when we replace it by certain alternatives, while leaving everything else the same. Thus, for each of the substitutions *Another one*, *The other two*, *Two others*, *One*, *Two* for *The other one* the conclusion about how many workmen there are will be different. Likewise, dependence on the subject of the second sentence is shown by replacing its subject by, e.g., *Two*, *At least two* or *Another one*.

The reason why the subject phrases of (191) produce the inferential effect observed has to do with their specific anaphoric properties – or in other words (given our liberal use of the term “presupposition”) with the specific presuppositions to which these phrases give rise. To give an idea of the interpretational mechanisms that are involved in this case without enmeshing us into too much detail, we will focus on the third subject NP *The other one*. We assume that the phrase *the workmen* has introduced a discourse referent *X* standing for a set of two or more workmen, and that the NP *one* has been interpreted as introducing a discourse referent *y* together with the condition “ $y \in X$ ” which says that the individual represented by *y* is one of the members of *X*.

When we look at the NP *the other one* more closely, we see that it gives rise to a “bundle” of presuppositions, each one of which is connected either with the lexical meaning of one of the words of which the NP is made up or else with a morphological feature. They are:

- (i) an anaphoric presupposition triggered by *one*, to the effect that there is a (nominal) predicate in context with which *one* can be identified
- (ii) a doubly anaphoric presupposition triggered by *other*, to the effect that the referent of the NP is distinct from some other individual or individuals of the same type, or belonging to the same set.

This presupposition is doubly anaphoric in that both of the following items must be identifiable in context:

- (a) the type or set which contains both the referent of the NP and the individual or individuals from which it differs, and

- (b) the other individual or individuals belonging to this type or set
- (iii) A presupposition connected with the fact that the NP is in the singular, to the effect that the NP's referent is a single individual, rather than a set of two or more individuals.
- (iv) A maximality presupposition connected with the definite article *the*, to the effect that in the given context the referent of the phrase exhausts the extension of the descriptive content of the NP.⁵⁷ **no more??**

The set X and its member y , both of which are part of the context within which the third sentence must be interpreted, provide a very good basis for satisfying this complex of presuppositions. Let's assume that ζ is the discourse referent introduced to represent the referent of the NP *The other one*. Identifying the predicate " $\in X$ " with *one*, and y with the presupposed individual(s) falling under the relevant predicate, which after this first identification becomes " $\in X$ ", deals with the presuppositions (i) and (ii), triggered by *one* and *other*. What remains is the singularity presupposition (iii), which says that ζ represents an individual, and the maximality presupposition (iv), to the effect that this individual exhausts the predicate of being a member of X that is distinct from y . Accommodating the assumption that the cardinality of X is 2, both these remaining presuppositions are fulfilled as well. It is also clear that no other assumption about the cardinality of X will lead to justification of both of these presuppositions.

presupposition ! accommodation

As in the case of (189.b), the interpreter is compelled to accommodate this information. (In fact, the accommodation comes so naturally to the human interpreter that audiences to which (191) is presented tend to have considerable difficulty at first in seeing what the point of the example could be.) Moreover, we do not see any way of embedding (191) in a larger discourse in which the "inference" is cancelled – in this regard (191) appears to differ from (189.b).

presupposition ! justification

Both examples suggest that our strategies for dealing with presuppositions in discourse involve some kind of "economy principle", which forces the interpreter to choose that presupposition resolution which gets by with the smallest amount of additional (i.e. accommodated) information. The extra information which must still be accommodated even when this most "economical" solution is chosen then appears as something that the discourse entails.⁵⁸

inference

One intuitively attractive way of thinking about accommodation for presupposition justification is to see it as a special form of *abduction*:⁵⁹ The interpreter of

presupposition ! maximality

⁵⁷The existence and uniqueness presuppositions which we assumed for definite descriptions in 4.2 can be seen as a combination of these three factors: (i) existence, (ii) maximality, and (iii) cardinality 1. Here these factors are attributed to (i) the very fact that an NP contributes a discourse referent, (ii) *the*, and (iii) the singular.

⁵⁸For some discussion of this aspect of presupposition justification, as well as for a motivation of the term "justification" which we have used freely within this Section, see [?] [DRS-Construction and Lexically Driven Inference, Theoretical Linguistics Vol (20, nr. 2/3, pp. 165-235].

⁵⁹The abduction-theoretic perspective on presupposition accommodation is argued persuasively and worked out in considerable detail in the doctoral dissertation of Krause. See [Krause2001].

an utterance is trying to find the “simplest” explanation for why the speaker would have uttered an expression which generates those presuppositions that his actual utterance does generate. From this abduction-theoretic perspective the fact that accommodations are often so compelling as to look like inference. One “abductive” accommodation may, when compared with possible alternatives, appear so unequivocally superior that the interpreter simply has no choice but to adopt it as the correct way to justify the utterance. Hence the impression that the accommodation is entailed by the sentence or discourse for which it is needed.

But a caveat is in order. The abduction-theoretic perspective allows us to see presupposition accommodation as part of a much more general type of problem – that of coming up with hypotheses which account for observations which would otherwise remain unexplained. However, the mechanisms of presupposition accommodation and the constraints to which it is answerable are closely adapted to the special structure of language and the principles of verbal communication, and so we can’t expect that seeing accommodation as a form of abduction will go very far in helping us to determine its special properties. All the hard work that is needed to uncover those mechanisms and constraints remains, even if the abduction-theoretic perspective promises to give us a plausible way of interpreting the results once we have them in front of us.

Our final point in this Section concerns accommodations that are needed to justify presuppositions occurring in embedded positions, such as, e.g. the *again*-presupposition of (189.b) and (190). So far, we have said nothing about *where* such accommodations are made: Is the accommodated information added to the global context, to the local context of the presupposition whose justification requires it, or at some context “intermediate” between these two in cases where there are such intermediate contexts. (In the case of (189.b) there aren’t any intermediate contexts, but often there are.)

In the case of (189.b) the question seems to be only of formal interest, for the proposition that Mary has her birthday before John is true or false categorically – its truth is not dependent on whether “we” have pizza on Mary’s birthday. In other words, the accommodation is one which affects the global context; whether we enter the accommodated information into the representation of the global context itself or into that of the antecedent of the conditional doesn’t make a real difference one way or the other.

This is not so, however, for a sentence like (192).

(192) Every Angelino uses his car to go to work; most New Yorkers use it only during the weekend.⁶⁰

When someone is offered this sentence out of the blue, the question whether all people from LA or New Yorkers have a car or his knowledge that many New Yorkers don’t are unlikely to bother him. He will assume that the speaker intends

⁶⁰Cf. [?], ??

to speak only of those people from Los Angeles and New York who do have cars. That is, he will interpret (192) as equivalent to (193).

(193) Every Angelino who has a car uses his car to go to work; most New Yorkers who have a car use it only during the weekend.

This observation has sometimes been taken as evidence that in some instances accommodation takes place at a non-global level. In relation to the first sentence of (192) the argument is as follows. The definite description *his car* creates a presupposition to the effect that the relevant individual y has a car, and the pronoun *his* contained in it gives rise to a further presupposition involving some anaphoric discourse referent u . These presuppositions are generated within the nuclear scope of the universal quantifier over Angelinos, so their local context (in our sense of “local”) is the restrictor of this quantifier. Following the representation in (150), we get an additional presupposition for the contextual restrictor C of the existence-and-uniqueness presupposition of the definite description. (194) gives the preliminary representation.

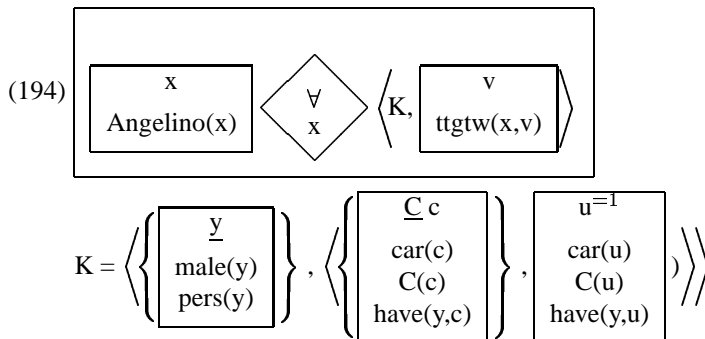

If we accommodate the three presuppositions adjoined to the nuclear scope of the quantifier in (194), we get the interpretation of the first conjunct of (192) that is given by the paraphrase in (193). And it seems that that is the only way in which we can obtain this reading. Thus, the argument goes, non-global accommodation is sometimes needed.

As Beaver ([?]) has observed, the problem with non-global accommodation is that it easily leads to overgeneration – that is, of readings for sentences with embedded presuppositions which human interpreters do not get. Moreover, we believe it to be in the spirit of his general view of presupposition accommodation to maintain that even in a case like (192) accommodation is a matter of adjusting the global context. The reason why global accommodation can give us the desired reading in the case of the first sentence of (192) is connected with an omission in its preliminary representation given in (194). Note that by our own standards (194) is incomplete. It fails to represent the contextual restrictor which, we already noted in 4.2, enters into the interpretation of quantifiers no less than in the (quantificational)

presupposition ! accommodation

uniqueness presuppositions of definite descriptions. When we add a representation of this restrictor and its representation to (194), as in (195), then the reading we are after can be obtained by global restriction too. In (195) it is assumed that the extension of the quantification restrictor C' contains at least one object of the kind explicitly specified by the quantifying NP.

presupposition ! accommodation

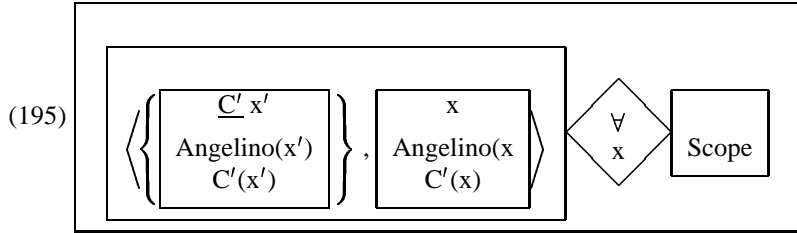

With Scope as in (194).

It is now possible to justify the set of presuppositions of the preliminary representation for the first sentence of (181) as follows. We globally accommodate the assumption that the predicate C' is one which is only true of persons in possession of a car, for instance by identifying C' with the predicate “there is a car such that – owns”. This allows us to derive from the updated global context the quantificational statement given in (196).

accommodation ! intermediate

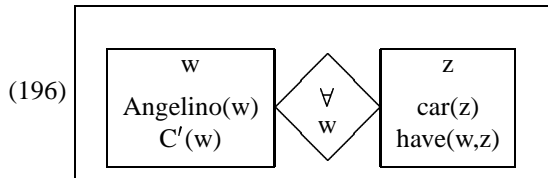

(196) enables us to enrich the antecedent of (195), which verifies all that the antecedent of (196) claims of the quantified variable w holds for its quantified variable x , with the information contained in the nuclear scope of (196). If we now resolve the anaphoric discourse referent y by identification with x , and the contextual predicate C by identification with “ $\in \{x,z\}$ ”, then the existence-and-uniqueness presupposition in 194 is satisfied too.

The moral of this story is that even in cases like this global accommodation can produce the desired effect as well as non-global justification. We want to stress in this connection that the assumption of the contextual restriction on the quantifier expressed by *every Angelino* is independently motivated. The reason we did not display such contextual dependencies of quantifiers before is that up to now they played no part in our considerations.

presupposition ! accommodation

The possibility of obtaining the intuitively plausible readings of sentences like (181) as the result of global accommodation is important to us, since we see the notion of non-global accommodation as conceptually problematic. When the context available to the recipient of an utterance U is insufficient for justification of

all the presuppositions it generates, it is natural for him to take himself to be underinformed about the context K_S that the speaker is actually assuming (or “presupposing”, in the sense of those who see presupposition as in the first instance a pragmatic phenomenon⁶¹) in producing U. If K_S weren’t capable of justifying all presuppositions of U, then the speaker surely wouldn’t have expressed himself in the way he did. On the basis of this “speaker knows best” principle the interpreter will, within a certain range delimited by further constraints on accommodation, assume that K_S is a context in which the information needed for justification is included. And if this is the rationale behind accommodation, then accommodation is an essentially global phenomenon.

We end this Section with a succinct statement of the two complementary theses on presupposition justification and accommodation to which we have committed ourselves here and in the preceding Section:

- (197) (General theses concerning the justification and accommodation of presuppositions in logically embedded positions)
- (i) A presupposition K must be justified in its local context K_l . (But the justification may use everything in the total information of K_l , $TILC(K_l, K, K_g)$.)
 - (ii) Accommodation for the sake of presupposition justification is always accommodation of the global context.

presupposition ! accommodation
accommodation ! intermediate

4.5 Construction of Preliminary Representations

Perhaps the greatest challenge for a DRT-based account of presupposition – as for DTR-based accounts of almost any aspect of natural language – is to formulate the rules according to which semantic representations are constructed. In the case of presupposition this challenge concerns in the first place the construction of the preliminary representations in which presuppositions are explicitly represented.

accommodation ! global

In view of the importance that representation construction has for any application of DRT, it may be felt as something of a let-down that this is precisely the part of the presupposition theory outlined here about which we will say next to nothing. Our excuse is that in order to do a proper job on this part of the theory we would have to go into much technical detail, which would detract from the more fundamental points where the present account differs from others. Also, it would have taken up so much space that little would have been left for other aspects of the theory. Given that within the present survey presupposition is only one of a substantial number of topics, the space we are devoting to it may already seem out of proportion as it is.

All we will do in this section is to outline the major issues with which a construction algorithm for preliminary representations has to cope. For further details we refer to [Kamp2001a] and to [Hans and Reylems].

⁶¹ See [?] [Stalnaker???, Presupposition, Pragmatics, Assertion?]

The first point is this. Rather than building representations from the sentences of a discourse by traversing their syntactic trees from the top down (as was done in the original formulation of DRT as, e.g., in [Kamp and Reyle1993]; for discussion see Section 2), we use a bottom-up algorithm.⁶² It is a familiar fact from other bottom up, “compositional”, definitions of sentence meaning (cf. e.g. [?], [?]), that these are often forced to make use of variable stores. (The need for variable stores arises whenever variables are introduced at one stage in the construction and bound at some later stage, with other stages in between.) This applies also to bottom up construction algorithms for DRT like the one that is at issue here. There the need for a store arises among other things for the location times of eventuality variables introduced by verbs.⁶³ According to the usual assumptions about syntactic structure these may get bound at a much later stage, when the construction process reaches the information contributed by tense. Many syntactic theories assume this information to be located at some functional projection of the verb fairly high up in the tree (such as Infl in pre-Minimalist versions of Chomskyan syntax), which can be at a considerable distance from the node of the verb itself. Variable storage, moreover, is also indispensable within the set up of U(nderspecified) DRT (see Section ??).⁶⁴

The algorithm for constructing preliminary representations uses variable storage widely. In particular, it assumes that the discourse referent representing its referent (or, in the case of quantificational NPs, the discourse referent which plays the role of the variable bound by the quantifier) gets introduced by the head noun, but may be bound only later on and thus must be kept in store until then. “Binding” of the discourse referent introduced by the lexical head of an NP can take various forms. Binding can be quantificational, in which case the element responsible for it is the determiner of the NP; it can be effected by some other, NP-external operator, as we find with indefinites, according to the proposals of FCS, classical DRT and other forms of Dynamic Semantics; or it can take one of the various forms of referent identification that are associated with the different types of definite NPs.⁶⁵

Among the different modes of referent identification for definite NPs there are, we have seen, in particular those which take the form of finding an anaphoric antecedent in the discourse context. Within the present discussion it is this anaphoric kind of binding that is of primary interest to us. In Section 4.1 we saw that such anaphoric binding is not only the standard form of binding for anaphoric pronouns

⁶²There are several proposals for bottom up construction of DRSS in the DRT-literature. See for instance [Asher1993], [Zeevat1989].

⁶³See e.g. [Reyle *et al.*2000]

⁶⁴See [Eberle1997]

⁶⁵In most cases, it is the determiner of the NP which tells us what kind of binding is wanted (even if it is only with quantificational NPs that the determiner then also takes care of the binding itself). With definite NPs the matter is a little more complicated, since many of these – proper names, pronouns and simple demonstratives – no clear separation between determiner and lexical head can be made. In these cases a more complicated story has to be told. For the purpose of the present discussion it suffices to assume that the single word of which such NPs are made up unites the function of lexical head (and thus variable introducer) and determiner (and thus indicator of binding mode) in one.

but that it also plays a part in the interpretation of at least some definite descriptions. Moreover, it is arguable that other-than-first occurrences of proper names in a discourse involve such “antecedent” binding as well; and that the same is true for certain simple and complex demonstratives. In all such cases the algorithm under discussion stores the discourse referent, x , that is introduced by the “anaphoric” NP initially, together with information about the way in which it is to be bound when the time for binding will have come – information which depends at least in part on what NP type (pronoun, definite description, proper name, demonstrative, ...) x belongs to. The account of “antecedent” binding presented here entails that at some point the store entry for such a discourse referent must be converted into the representation of the sort of anaphoric presupposition we have encountered in the preceding sections, and this representation adjoined to that part of the representation under construction which contains the store of the given entry.

To give an impression of how the discourse referents introduced by (the heads of) anaphoric NPs are processed by the construction algorithm for preliminary representations we present a selection of the successive stages in the construction of the preliminary representation of (158.b) of Section 4.2. This will also reveal some other aspects of representation construction by this algorithm. We will not explain all details of the construction, nor of the notation used to record its various intermediate stages. The interested reader will have to consult the papers mentioned at the beginning of this Section.

(158.b) Every friend of mine who has a rabbit overfeeds it.

The NP *a rabbit* leads to the representation in (198).

$$(198) \left\langle \left\{ \langle y, \boxed{\text{rabbit}(y)}, \text{indef.art} \rangle \right\}, \boxed{\phantom{\text{rabbit}(y)}} \right\rangle$$

This representation consists of a variable store with one entry (for the variable y) and an empty DRS. (This DRS is to be thought of as representing the predication which involves the NP as argument. It will get filled when the representation of the NP is combined with that of its predicate – here the verb *have*. (At that point the empty DRS of (198) gets merged with that which represents the predicate and the resulting DRS is empty no longer.) The entry for y consists, as do all store entries, of three components, (i) the variable itself; (ii) a simple or complex predication of this variable, presented in the form of a DRS (also often empty); and (iii) a “Binding Constraint”, which can be inferred from the source introducing the variable or its syntactic environment – here the indefinite determiner *a*. These Binding Constraints are presented here only schematically, by expressions like “indef.art”. These expressions should be seen as abbreviations of the often complex binding information that a full and explicit presentation of the construction algorithm must spell out in detail.⁶⁶

presupposition ! accommodation
accommodation ! global

⁶⁶The spelling out of “indef.art” and other Binding Conditions is arguably the most demanding part

What has just been said about *a rabbit* applies mutatis mutandis also to the two other NPs, the complex Subject NP of the sentence beginning with *every*, and the direct object pronoun *it*. The representation for *it* is given in (199), that for the subject NP in (200).

$$(199) \left\langle \left\langle \langle u, \boxed{\text{non-pers}(u)}, \text{an.pron} \rangle \right\rangle, \boxed{\phantom{\text{non-pers}(u)}} \right\rangle$$

$$(200) \left\langle \left\langle \langle x, \boxed{\begin{array}{c} \text{fr.o.m.}(x) \\ \langle \langle y, \boxed{\text{rabbit}(y)}, \text{indef.art} \rangle \rangle, \boxed{\text{have}(x,y)} \end{array}} \rangle, \text{every} \rangle \right\rangle, \boxed{\phantom{\text{non-pers}(u)}} \right\rangle$$

(199) is much like (198), the only difference being that its Binding Constraints are now the presuppositional ones of anaphoric pronouns rather than the indefinite Binding Constraints of *a*-NPs. The story of (200) is more complicated. To obtain this representation several construction operations are needed. Some of these are required for the construction of the representation of the relative clause, and one for the combination of that representation with that for the lexical head *friend of mine* (which for presentational purposes we treat here as if it were a single noun). The main point here is that the integration of RC representation and head noun yields a complex representation for the second component of the store entry for the subject, one which once again has the form of a DRS preceded by a variable store.

Combining the representation of the direct object with that of the verb *overfeed* yields (201) and combining that with (200) the representation in (202).

$$(201) \left\langle \left\langle \langle u, \boxed{\text{non-pers}(u)}, \text{an.pron} \rangle \right\rangle, \boxed{\text{overfeed}(\text{ARG}_{1,u})} \right\rangle$$

$$(202) \left\langle \left\langle \langle u, \boxed{\text{non-pers}(u)}, \text{an.pron} \rangle \right\rangle, \boxed{\text{overfeed}(\text{ARG}_{1,u})} \right\rangle$$

$$\left\langle \langle x, \boxed{\begin{array}{c} \text{fr.o.m.}(x) \\ \text{K} \end{array}} \rangle, \text{every} \right\rangle$$

with $\text{K} = \left\langle \langle y, \boxed{\text{rabbit}(y)}, \text{indef.art} \rangle \right\rangle, \boxed{\text{have}(x,y)}$

(202) can now be converted into the desired preliminary representation by *implementing* the Binding Constraints. We assume that the variable *y* for the indefinite gets bound locally, in the familiar DRT-mode of insertion into the local DRS universe. (The effect of this assumption is that the indefinite is interpreted as having narrow scope with respect to the universal quantifier expressed by *every*. The binding of *y* has the effect that the predicate occupying the second slot of its store entry

of the entire algorithm specification. In fact, much of the linguistic literature on the semantics and pragmatics of different types of noun phrases can be seen as relevant to the exact form in which the Binding Constraints should be stated.

gets added to the DRS whose universe receives y . In the present case this is the DRS for the second slot of the store entry for the subject NP, which becomes the restrictor of the duplex condition that results from implementing “every”. These two conversions of Binding Constraints into actual bindings yield (203).

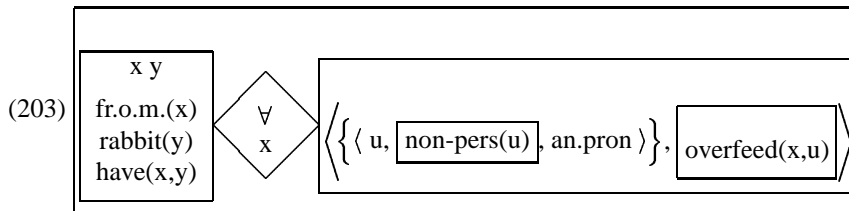

Implementation of the presuppositional Binding Constraint then yields the preliminary representation (161) of 4.2 (if we abstract of the present treatment of *friend of mine* as an atomic 1-place predicate. From this representation one then derives, by the “local” presupposition resolution described in Section 4.2, the final representation (162).

The computation of the representations of pronoun presuppositions is simple in that it has to deal with a fixed (and very limited) amount of descriptive information. With other kinds of presuppositions – including in essence all the presuppositions that are considered in the long tradition of non-anaphoric approaches to presupposition, from Frege to Heim – this is not so: For all such “traditional” presupposition types there is no upper bound to the complexity that this descriptive information can have. This is plain for factive presuppositions – the complement of a factive verb can be as complicated a sentence as you like. But it is equally true for the existence-and-uniqueness presuppositions of definite descriptions – since there is no upper bound to the complexity of the relative clauses that definite descriptions can contain – or for *again*-presuppositions, since *again* may have scope over a VP which includes NP arguments, PP adjuncts, or subordinate clauses, and for each of these categories complexity has no upper bound. Similar considerations apply to all other presuppositions which in earlier theories were treated as “presupposed propositions”.

The problem that all these presuppositions present for the construction of preliminary representations was mentioned in Section 4.3: The representation of the presupposition must be obtained as a “copy” of the representation of the sentence part to which the trigger applies. (It is useful in this connection to think of the presupposition trigger as an operator whose operand is the part whose representation must be “copied” to get the representation of the presupposition it triggers. It is immaterial in this connection whether the part in question is a complement of the trigger, as with the typical factive verb, or the trigger an adjunct to the part, as we find with adverbs such as *again* or *too*. We will illustrate a couple of aspects of the copying problem for the case of *again*-presuppositions, starting with example (167) of Section 4.3.

storage

(167) John made a mistake again.

One preliminary representation for (167) was given in (170), also repeated here.

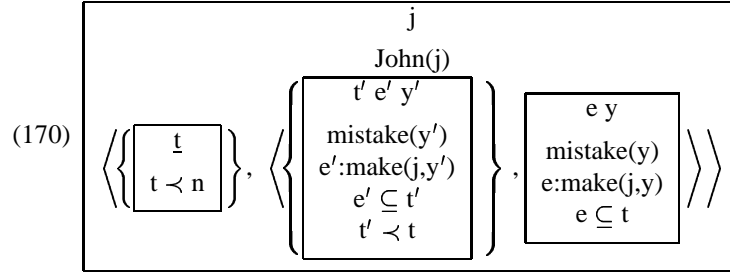

To get a better grip on what is involved in the construction of such a representation we give the representation of that part of the syntactic analysis of the sentence which immediately precedes the construction stage just before the trigger *again* comes into play. We assume that *again* is an adverbial adjunct to the VP, so the representation in question is that of the VP. This representation is given in (204).

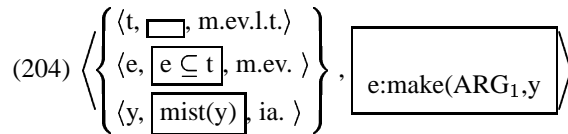

(204) has a store with three entries, one for the variable introduced by the direct object, and two, *e* and *t*, connected with the eventuality described by the verb, the eventuality *e* itself and its location time *t*. The respective Binding Constraints “m.ev.l.t.” and “m.ev.” contain information pertinent to the binding of these variables. “m.ev.l.t.” – “m.ev.l.t.” is short for “main eventuality location time” – abbreviates a complex set of conditions which articulate the various ways in which such location times can be bound.⁶⁷ All we need to know in connection with the present example is that the indexically constrained anaphoric binding represented in (170) is among the options “m.ev.l.t.” provides for. By comparison the Binding Constraint “m.ev.” for *e* is simpler. We assume that *e* gets bound by insertion into an appropriate DRS-universe.⁶⁸

⁶⁷The matter is as complex as it is, because binding of location times can take many different forms. One possibility is the indexical binding by finite tense (as we assumed in our treatment of (167) in 4.3, via the condition “*t* < *n*” and an additional requirement of antecedent-binding in context). But there are many other possibilities as well. Location times can be bound, either internally to the clause containing the verb responsible for its introduction or externally to it, via the binding relations that often exist between finite subordinate clauses and the clauses to which they are adjoined, gerundival and other infinitival constructions (including control), adverbial quantification and aspect operators, and possibly others as well. [Reyle *et al.* 2000] give an impression of this complexity, even when restricted to possibilities of clause-internal binding. For discussions of clause-external binding see e.g. [?], [?] or ??).

⁶⁸The default assumption is that *e* gets inserted into the universe of the DRS which contains the condition “*e*:...” as one of its conditions. But sometimes there are other possibilities as well. In this regard eventuality discourse referents are much like those introduced by indefinite NPs, although we don’t know how close the similarities are.

It is from the structure in (204) that the presupposition triggered by *again* must be constructed. One question which the formulation of this operation must address is which elements of the store require duplication and which do not. Our earlier treatment of this example took it for granted that all store elements are to be duplicated, but we will see that this is questionable. Another question concerns the eventual scope which these store elements acquire when Binding finally takes place. As we saw in Section 4.3, a precondition of the presupposition construal represented in (170) was that the variable *t* be bound anaphorically. This decision amounts to a kind of “disambiguation” of “m.ev.l.t”, which we abbreviate “m.ev.l.t;an.”. This means that *t* is not only related by tense to the utterance time *n*, but that moreover it is identified with some (past) time t_0 provided by the context. The main point of this “disambiguation” of “m.ev.l.t” there was, it enabled us to enter the temporal precedence condition “ $t' \prec t$ ” into the representation of the presupposition, rather than into the non-presuppositional part. Formally, however, this possibility depended on the *t*-presupposition having wider scope than the *again*-presupposition. By we would now want the *again*-presupposition to be within the scope of the store element for *t*.

What should we assume to be the scope relation between the *again*-presupposition and the other store elements of 204? For the present example it won't matter which way we decide. But a general principle is needed on the basis of which decisions are to be made. At this point we do not feel able to state such a principle, but even only put forward a few hints about the form it should take.

First, a correlation between the scope question and another one which is even more important. (It matters in almost all cases, the example before us among them.) This is the question which of the elements in the store of the representations that is in the scope of the trigger at the point when the representation is constructed for the triggered presupposition need be “copied” – i.e. whether a store element of the same form but involving a different discourse referent should be included in the store of the representation for the triggered presupposition. The natural correspondence seems to be this: Precisely those store elements of the argument representation of the representation in the scope of the presupposition trigger should be copied into the store of the representation of the triggered presupposition which remain within the scope of the new presupposition representation in the representation which results from its construction.

This correlation doesn't tell us, however, how either decision – which store elements remain within the scope of the new presupposition, which store elements must be copied – is to be made. This is a hard problem since so many different factors seem to impinge on its solution. And as with other questions of semantic scope, there appears to be room for genuine underspecification by syntactic form. The best way to deal with this and other scope problems is therefore, we believe, with the setting of UDRT (Underspecified DRT) as discussed in Section ???. Among the various constraints on the solution to the present scope problem there is one which deserves to be mentioned here, as it concerns the interaction between presuppositions. In general some of the store elements that may occur

within the scope of a presupposition trigger like *again* may be presuppositional themselves. These are the store elements introduced by definite NPs which will have to be converted into presupposition representations at some stage. (In the discussion above it was assumed implicitly that this happens at the point when the input tree to the construction process has been entirely transformed into a representation form of the kind illustrated in the representations (198)-(204) above. But for the present point it doesn't really matter when we take these conversions to take place.) What can be said about the scope relations between different presuppositions? In many cases, including all those where the presuppositions in question are resolved globally, their scope relations within the preliminary representation are of no consequence. But there are also cases where this matters. One case is discussed at length in [Kamp2001a]. A sentence like

(205) Fred has pawned his watch again.

is ambiguous between an interpretation according to which there was a simple watch which he pawned, then retrieved from the pawnshop and then pawned again, and a reading on which he pawned one watch, then got another one and then pawned that one too. The second interpretation can be obtained (within the present theory) only by copying the presuppositional store element which *again* finds in its scope. Rendering the possessive relation conveyed by *his* dependent on time, so that we can evaluate this relation to the time t of the asserted event in the presupposition representation adjoined to the assertion and to the time t' of the event presupposed by *again* in the copy of that representation then makes it possible to obtain two distinct referents, each of which was the unique satisfier of the relevant conditions at the relevant time. The interpretation according to which the same watch was pawned twice can also be obtained in this way, viz. when the unique satisfier of the given condition at t' is in fact the same as the unique satisfier at t . (According to this analysis the difference between the two cases isn't really a matter of two different *readings* but of two different situations to which the same semantic representation is true, which seems to be in accordance with the intuitions which some speakers have expressed about such examples like (205).

But does (205) also have another reading, which we obtain by giving the presupposition for the definite description wide scope over the *again*-presupposition? The matter is difficult to decide, since there is in principle always the possibility of making the conditions of the original presupposition representation and its copy identical, so that they will resolve to the same referent. It is important, however, to distinguish in the present connection between definite descriptions and pronouns. In a discourse like (206)

(206) Fred hasn't got his watch on him. In fact, he has pawned it again.

the strongly preferred interpretation seems to be that the same watch was pawned twice. Anaphoric pronouns, it would thus seem, – and the same thing may well be true of anaphoric presuppositions (in the sense of 4.3) in general – come with

the requirement that they “may be resolved only once”. There are various ways to make sure of this within the present framework. One is to insist that anaphoric presupposition representations (or the store elements that are destined to become anaphoric presupposition representations) always are given scope over the presuppositions generated by *again* when the presupposition occurs within the trigger’s scope. (Though other stipulations to the same effect are possible too.)⁶⁹

We summarise this inconclusive discussion by stating once more the problem that it addressed: When the representation must be constructed for a presupposition-triggering particle like *again* and the representation in its scope has a store S , then the question arises which of the elements of S should get scope over the new presupposition representation and which should remain within the scope of the new representation. We assume that in general the new representation cleaves S into two parts, of the elements with wider and the elements with narrower scope. But the principles which govern this division require further investigation.

In the case of (204) we decided, in keeping with our earlier analysis of the example, that only the t-presupposition should get wide scope over the *again*-presupposition, while the other two elements of the store remain within the scope of the new presupposition, and at the same time yield copies within it. The result is given in (208).

$$(208) \left\langle \left\{ \langle t, \square, \text{m.ev.l.t.;an.} \rangle \right\}, \left\langle K, \left\langle \left\{ \langle e, \boxed{e \subseteq t}, \text{m.ev.} \rangle \right\}, \boxed{\text{make}(\text{ARG}_{1,y})} \right\rangle \right\rangle$$

$$\text{with } K = \left\langle \left\{ \langle t', \boxed{t' \prec t}, \text{m.ev.ag-pr.l.t.} \rangle \right\}, \boxed{\text{make}(\text{ARG}_{1,y'})} \right\rangle$$

$$\left\langle \left\{ \langle e', \boxed{e' \subseteq t'} \rangle, \text{m.ev.ag-pr.} \right\}, \left\langle \langle y', \boxed{\text{mist}(y')} \rangle, \text{ia.} \right\rangle \right\rangle$$

“m.ev.ag-pr.” and “m.ev.ag-pr.l.t.” stand for “main eventuality of an *again*-presupposition” and “location time of the main eventuality of an *again*-presupposition”. The Binding Constraints “m.ev.ag-pr.” and “m.ev.ag-pr.l.t.” are short for the special Binding Constraints appropriate for such variables.

There is a difficulty here which we passed over in our discussion of *again*-presuppositions in Section 4.2: Should we see the presupposed variable e' and its location time t' as existentially quantified within the *again*-presupposition, so that this presupposition has the status of a presupposed proposition? Or should one or

⁶⁹The distinction between pronouns and definite descriptions is more complex than the above remarks imply.

(207) Fred is without a watch. He has pawned it again.

can be said perfectly well in a case where Fred pawned two different watches at two different times. Examples like this one seem to be to the famous paycheck examples (*The man who gave his paycheck to his wife was wiser than the man who gave it to his mistress*). But exactly how this connection should be accounted for is left as a question of further investigation.

both of them be treated as anaphoric discourse referents? Our discussion in Section 4.4 of the justification of the *again*-presupposition of Kripke’s example (189.b) and its variant (190) might seem to suggest the second view. After all, in the two cases of justification that we considered in Section 4.4 the context did provide an event with which e' could be identified (as well as a time for the identification of t'). On the basis of other cases, however, it appears to us that for the justification of an *again*-presupposition no explicit representation of an eventuality and/or location time in the context is required; it is enough if the context can be seen to entail that there was an earlier occurrence of an eventuality of the desired type. Hence no underlining of e' and t' in (170).⁷⁰

4.6 Conclusion

This very brief Section serves both as a conclusion to the Section 4.5 and as conclusion to Section 4 as a whole. We extract what we see as the most salient features of the presupposition theory presented here.

1. The general approach towards the theory of presuppositions of which the first explicit version in print is [van der Sandt1992] and of which the present proposal is an instance, implies a sharp separation between:

- (i) the *computation* of presuppositions, which is part of the construction of the preliminary sentence representations in which presuppositions are explicitly represented, and
- (ii) their *justification*, which is part of the integration of the preliminary representation with the context.

This separation “presupposes” a two level DRT architecture, in which sentences are first assigned a preliminary representation which is then subsequently connected with the context representation.

In recent years it has been principally the second problem, that of presupposition justification, on which most of the work in presupposition theory was focussed. The problem of presupposition computation has often been bypassed, partly, we suspect, because systematic proposals for a syntax-semantics interface which includes presuppositional phenomena were lacking altogether. But the problem of presupposition computation should not be underestimated. There are various reasons why it shouldn’t be. A particularly important one is that so often, and in the plainest and seemingly most innocent uses of language, a single sentence will give rise to several presuppositions at once.

⁷⁰It should be clear that the absence of underlining for these variables is a reflection of the Binding Constraints “m.ev.ag-pr.” and “m.ev.ag-pr.l.t.”. Generally, presence or absence of underlining is something that the Binding Constraints for the variables of presupposition-triggering NPs must make explicit.

storage

binding constraint

presupposition ! *again*

2. Following [van der Sandt1992], the theory is set up to deal with phenomena which have been traditionally classified as cases of presupposition and those that have been classified as cases of anaphora in largely parallel ways. Nevertheless differences between these two kinds of phenomena remain. The present theory endeavours to do justice to these differences by distinguishing between anaphoric presuppositions and non-anaphoric (or “purely propositional”) presuppositions. Whether or what further distinctions will prove necessary is a matter which we have left open.

3. The theory makes a sharp distinction between presupposition justifications that are accommodation-free (cases which in [van der Sandt1992] and elsewhere are described as “presupposition binding”), and cases where accommodation plays a role. One difference between justification and accommodation on which the present theory insists is that justification is always “local” and accommodation always “global”.

4. The theory is designed to deal not only with single presuppositions individually but also with the (extremely common) cases where a single sentence generates several presuppositions at once and where these interact in often intricate ways. This is a domain in which there is need for much further work, both with regard to presupposition computation and to presupposition justification.

5 PROPOSITIONAL ATTITUDES

5.1 *Introduction*

There is a natural connection between DRT and the description of propositional attitudes, such as belief, desire or intention. The most direct connection is with belief. According to DRT, interpretation of an assertion one hears or reads takes the form of constructing a DRS for it. One way to think of this DRS is as a structure which the interpreter forms in his mind and which for him identifies the content of the interpreted statement.

In most presentations of DRT this connection is played down: as a theory of semantics, it was felt, DRT should be able to stand its ground without reference to the minds of language users. Emphasising the psychological angle would only have detracted from those aspects of the theory which make it useful as a tool for linguistic analysis in which the mental plays no direct part. The conviction that linguistics should stay clear from assumptions about what goes on in the heads of speakers or hearers was particularly strong within the context in which DRT was first developed (that of the formal semantics community of roughly twenty five years ago), and there was a correspondingly strong reluctance to dwell on the psychological potential of the theory. In the meantime, suspicion of reference to the mental has lessened even among formal semanticists. But even today it seems good policy to keep those aspects of DRT that make it a “mind-neutral” theory of meaning separate from what the theory might have to say about mental representation. This is the policy that we ourselves have followed in earlier work on DRT and to which we have also stuck in the present overview.

It should nevertheless be admitted that the idea of a mental representation which the interpreter of a sentence, text or bit of spoken discourse builds was an essential motive for developing DRT, even if the standard formulations of DRT that have made it into print bear little evidence of this. Witness to this are publications which explicitly explore the possibilities of DRT as a theory of propositional attitudes. Some of this work goes back to the eighties (cf. [Asher1986, Asher and H.Kamp1989, Kamp1990, Asher1993]).

The reason why the psychological significance of DRSs seemed a promising line of investigation from the start is directly connected with what DRT has to say about the semantics of indefinite expressions and anaphora to indefinite antecedents (highlighted by donkey sentences and donkey discourses; see Section ??): Suppose that a recipient B has just interpreted a sentence containing an indefinite NP α and that the next sentence he must interpret contains a pronoun for which α is a fitting antecedent. According to DRT the anaphoric connection between pronoun and NP can be established by identifying the discourse referent for the pronoun with the one for α . It is tempting to think that this account of what goes on in establishing indefinite-pronoun links tells us something about how the content of interpreted sentences is represented in the interpreter’s mind: the indefinite α does give rise, at the level of mental representation, to the introduction

of an entity representation (corresponding to the discourse referent for α) and this representation can then serve, just as could in principle any other entity representation in the mind of the interpreter, as an antecedent for anaphoric noun phrases occurring in sentences that are to be interpreted subsequently.

The fact that cross-sentential anaphora works in the way the theory predicts (with some exceptions, but on the whole the number of these does not seem damning), and that the theory gives such an apparently simple account for it, was one reason for thinking that DRSs capture some genuine aspect of the way in which the mind represents mental content. A further early reason for thinking this was the observation, due to Partee, that pronominal anaphora is sensitive to the form of the preceding sentence, and not just to its “propositional” (i.e. intensional) content: “It is under the sofa.” can be understood as a statement about the missing marble when it follows “One of the ten marbles is not in the bag.” but not when it follows the propositionally equivalent “Nine of the ten marbles are in the bag”. (See section 3.1 This distinction is also captured effortlessly by DRT, and it is one which seems to go directly against the fundamental assumptions about semantic content that were dominant within formal semantics at the time.

Even if these and other facts (some discovered by psycholinguists over the past twenty years) make it plausible that entity representation (including representation of entities introduced by indefinite NPs) has psychological reality, we must, when it comes to claiming psychological reality for the representational form of DRSs generally, tread very carefully. About the mental representation of predication very little is apparently known even today. Thus it would be premature to consider all aspects of the form of DRSs as capturing aspects of psychological reality.

In this section we will discuss an extension of DRT, in which DRSs will be used to identify mental representations of content. We want to remain agnostic, however, on the question precisely which features of DRSs are psychologically significant and which are not, leaving these questions to be settled by future work in cognitive science.⁷¹ We certainly do not advocate wholesale adoption of the DRS-format as psychologically significant in each and every respect.

5.2 *Extending DRT to a Formalism Capable of Describing Attitudinal States and Attitude Attributions. Some Examples Semi-Formally Treated*

As indicated above, a principal motive for applying DRT to the analysis of mental contents is its ability to deal with cases of cross-sentential donkey anaphora and the way in which it does this: the new sentence with the anaphoric pronoun is interpreted via a representation in which the discourse referent of the pronoun is

⁷¹In this respect the account presented here is less committal than, for instance, [Asher1986], where the form of DRSs is used to arrive at an account of the identity conditions of beliefs and other propositional attitudes. Our own inclination on this point is that the concept of identity for beliefs and other propositional attitudes is too context-dependent to allow for a characterisation once and for all in any case.

identified with that of its antecedent. A consequence of this is that the DRS K_2 for the new sentence is not a proper DRS; one of the discourse referents occurring in conditions of K_2 , viz. the discourse referent for the pronoun's antecedent, is not bound within K_2 itself, but in the DRS K_1 which represents the preceding sentence or sentences and serves as context of interpretation for the new sentence.⁷² In standard DRT the non-properness of K_2 does not cause problems, since what counts in the end is only the merge of K_1 and K_2 , and that DRS will normally be proper even if K_2 isn't.

For the question how content is mentally represented, cases of cross-sentential anaphora to indefinite antecedents hold a double moral. First, if the representation of content is along the lines DRT describes, then representation of new information, and thus of the content of newly acquired propositional attitudes, will take the form of "pegging" the new representation on one that is already in place. By itself the new representation would not determine a well-defined propositional content; it succeeds in doing so only in conjunction with the representation of some other attitude, on which it depends "referentially". Let us assume that the recipient of a two-sentence discourse in which the second sentence is in such an anaphoric dependence on the first sentence, that both sentences are assertions which communicate new information to him and that the recipient accepts both bits of information as true and thus forms the corresponding beliefs. It is natural in such a situation to think of the first DRS, K_1 , which (we assume) the recipient has formed as the result of his interpretation of the first sentence as representing for him the content of the first of his two beliefs, and of the second DRS, K_2 , the result of his interpreting the second sentence, as representing the content of the second belief. So far the story may seem barely distinguishable from the one which standard DRT tells about incremental interpretation of discourse. But there is one difference with what we have been assuming so far, and it is a difference that is crucial. For in the present context it is no longer possible to simply amalgamate the new, improper representation K_2 with the DRS K_1 on which it depends. The reason is that the attitude whose content is represented by K_2 may be of a different kind from the one represented by K_1 . For instance, K_2 may represent a belief with a lower confidence degree than K_1 . Or, more dramatically, the attitude represented by K_2 could be a desire while that represented by K_1 is a belief; and so on. To give an example of the first case, consider a situation in which two philosophers, Φ_1 and Φ_2 , are talking over coffee. Φ_1 is telling Φ_2 about the last convention he went to, and which Φ_2 had decided not to attend. "You know", he says to Φ_2 ,

(209) "I gave my paper on implicature, the one you have seen. There was one person in the audience who objected – of course I was prepared for an intervention of that kind – that not every case of inference is a case of implicature. Well, I wiped the floor with him."

⁷²Note that this is so irrespective of whether we insert the discourse referent α for the antecedent in the argument slots of the pronoun, or proceed as we have here, viz. by introducing a separate discourse referent β for the pronoun and then add to K_2 the condition " $\alpha = \beta$ ".

Let's assume that Φ_2 , in accordance with the speaker's referential intentions, interprets *him* as anaphoric to *one person in the audience*. This makes her representation of the third sentence in (209) referentially dependent on her representation of the first sentence. But let us assume also that Φ_2 , while seeing no reason to doubt that the first two sentences of (209) are true, doubts the truth of the third: she knows Φ_1 as a rather inflated person, who tends to be out of touch with reality where his ability to convince or impress others is concerned. So she registers the first two sentences as belief (with a high confidence degree), and the third sentence as a doubt. The two representations must be kept separate, one as specification of the content of a belief and the other as specification of the content of a doubt; amalgamating them would obliterate the crucial demarcation between what is accepted as true and what isn't. It follows from this that DRS-merge can no longer be used to account for the binding problem connected with cross-sentential anaphora.

Our second example shows that the problem illustrated by the first is not restricted to attitudes which arise through the interpretation of language.⁷³ A stamp collector opens the lid of a box which contains an unsorted miscellany of stamps. He has been told he can pick one stamp out of the box and keep it. He perceives (or thinks he does) a copy of the 2d stamp of the 1840 edition of Great Britain (showing the head of Queen Victoria), but of which only a tiny portion is visible to him. (Stamp collectors are known to develop an uncanny ability to identify stamps even if only a tiny part of them is exposed to view.) The 1840 2d of GB is a stamp for which he is always on the look-out. So his perceptual experience instantly produces in him (i) the belief that there is a copy of this stamp in the box, (ii) the desire to make this copy his own; and (iii) the resolve to pick the stamp out of the box (thereby making his desire true).

Let us assume that each of these attitudes can be represented as a pair consisting of (a) a representation of its propositional content and (b) an indicator of its *attitudinal mode* – that is, some feature which distinguishes between beliefs, desires, intentions, etc. For simplicity we will assume just three such mode indicators here – BEL, for belief, DES, for desire, and INT, for intention. This way of representing propositional attitudes “two-dimensionally” allows among other things for the possibility that the same propositional content representation can combine with different *mode indicators*. This corresponds to the possibility of representing attitudes with the same content but distinct modality, as when two different persons hear the same assertion and assign the same interpretation to it, but where one accepts it as true, while the other withholds judgement; or when a person first believes something but then discovers this belief to be false; or when someone has a fervent hope that something is the case (e.g. that his beloved is still alive) and then finds his hope confirmed. The representation of attitudes which coincide in content but differ in mode is especially important in the description of dialogue – where the participants will often have different attitudes towards the same proposi-

mode indicator

⁷³See Kamp (2001) [German translation of “A DRT-based account of propositional attitudes and indirect discourse”] ????.

tion – and also in describing how attitudinal states change in time, either under the influence of new incoming information or as a consequence of internal information processing (i.e. reasoning).⁷⁴

Given these assumptions, and ignoring for the moment the temporal dimension, we can represent the complex of the three attitudes that, in our presentation of the case, result from the (presumed) perception of the Queen Victoria stamp as follows:

$$(210) \quad \left\langle \text{BEL}, \begin{array}{c} x \quad z \\ \hline 2d-1840-GB(x) \text{ (the box)}(z) \text{ in}(x,z) \end{array} \right\rangle$$

$$\left\langle \text{DES}, \begin{array}{c} \hline \text{poss}(i,x) \end{array} \right\rangle$$

$$\left\langle \text{INT}, \begin{array}{c} \hline \text{pick-from}(i,x,z) \end{array} \right\rangle$$

The first point connected with (210) is that the discourse referent x for the stamp, which is bound in the belief-component (through its presence in the universe of the belief DRS), recurs in the desire and the intention components. So the DRSs of these components do not determine a well-defined propositional content without support from the belief DRS. The second point, to which we will return below, concerns the symbol “ i ”. “ i ” is specific to attitude representations and there it stands for the “self”, i.e. for the bearer of the attitude as he immediately perceives himself, in particular as the subject of his own perceptions and actions. Thus “ i ” acts as an indexical discourse referent. A token of “ i ” which occurs in the representation of an attitude of an agent A will ipso facto stand for A .⁷⁵

discourse referent ! indexical

⁷⁴The possibility of representing attitudes in this way is also important for accounts of belief revision which pay closer attention to the form in which new information becomes available than is done in the classical approaches to belief revision. (For the classical approach see e.g. [Gärdenfors1988].)

⁷⁵In this regard “ i ” is reminiscent of the indexical discourse referent “ n ”. We saw in Section 3.5 that an occurrence of “ n ” always stands for the utterance time of the sentence represented by the DRS containing it. In fact, as we will explain presently, “ n ” also has a use within the representations of propositional attitudes. However, there are also important differences between “ i ” and “ n ”.

Representations of beliefs and other attitudes which contain “ i ” should be distinguished from representations which contain in lieu of “ i ” a non-indexical discourse referent x which (as it happens) represents the thinker himself. Such a “non-first person” discourse referent x can be internally and externally anchored to the thinker (for anchoring see **Section ??**), but the anchors may be such that they do not enable the thinker to realise that he himself is the individual represented by x . In other words, these anchors do not enable him to make the transition from the thought representable as “ $P(x)$ ” to the one representable as “ $P(i)$ ”. Kaplan’s well-known case of the man who sees a person in the mirror whose trousers are on fire, who doesn’t at first realise that he is that person, but for whom the penny then drops, can be described in our DRS language by a sequence of two attitudinal states, the first containing a belief representable as $\{ \{y\}, \{ \text{trousers-of}(y,x), \text{on fire}(y) \} \}$, with x internally anchored and externally anchored to the man (for details see **Section ??**), while the second state, which supplants the

The third point is that the “referential sharing” between the belief, the desire and the intention of (210) which is captured by the occurrences of the same discourse referent x in each of them, is a decisive factor in the way in which someone whose mental state includes these attitudes may be expected to “act” – internally (i.e. in thought) as well as externally (i.e. in acting upon his environment). The belief that there is a 2d stamp from the 1840 edition of Great Britain in the box, we suggested, gives rise to the desire to be in possession of “that stamp”, and then to the intention to take it out of the box. And the action into which this intention is likely to result – that of reaching for a stamp assumed to be the 2d. 1840 Queen Victoria and seen to be at a certain place in the box – will be guided by this intention (in combination with a further belief, or aspect of the displayed belief, which concerns the precise location of the stamp in the box, one that also comes from the perception, but which we didn’t display in (210)). The desire and intention develop out of the belief as desire and intention *about the same object the belief is about*. And here the sense of “the same object” is clearly a psychological one, which controls the internal development of thought and its eventual manifestations through action.

In fact, it is important to distinguish this internal sense of “same object” from the external sense which is prominent in many philosophical discussions of meaning, reference and the content of propositional attitudes. These discussions typically focus on cases where two expressions refer to the same real world entity, but where a particular speaker (or thinker) may be unaware of this, or alternatively where a speaker takes two expressions (or occurrences thereof) to refer to the same thing although in actuality they refer to distinct real world entities.⁷⁶ The internal sense of “sameness of reference” that we are dealing with here is different. The difference comes out clearly when we consider cases of misperception. Suppose first that our stamp collector has falsely concluded that a particular stamp, of which he glimpsed a corner, was the 2d 1840 of Great Britain. In this case the belief he forms can be construed as a false belief about a particular object (i.e. the stamp whose corner he misinterpreted). The desire and intention could then also be directed towards this stamp, even though the collector would not have had these attitudes if he wasn’t under this misconception. If he implements his intention by taking the stamp out of the box, he will be disappointed. But the process leading up to this action will be, from an internal, psychological perspective, just as in the first case.

Misperception, however, can also be more radical than this. The belief that there is a specimen of the 2d 1840 of Great Britain in the box may have been caused by some combination of optical factors that led to this illusion without there being any one stamp in the box that is directly responsible for it – there is no stamp of which it could be said that the observer had misidentified that stamp as the 2d 1840 of GB. In such cases it is plausible to hold that the belief – and with it the desire and the intention – are not about any one object in particular. This is the position we

first when the penny drops, contains instead a belief represented as $\langle \{y\}, \{\text{trousers-of}(y,i), \text{on fire}(y)\} \rangle$.

⁷⁶See, as one among many places in the philosophical literature, [Kripke1979].

adopt in relation to cases of this latter sort. In fact, we will argue below that if the situation is as in this last scenario, then the representations in (210) fail to define a propositional content altogether (although there are closely related representations which are also within reach of the agent and which define the corresponding existential propositions, e.g. the proposition that there is a specimen of the 2d 1840 of GB in the box).

We assume that the crucial difference between this last case and the first two is that the discourse referent *x* has an external anchor in the first two cases, but not in the last one. What we mean by this can be explained as follows. Our point of departure is a causal theory of perception according to which direct perception of an object involves a certain kind of causal relation between the thing perceived and the perceiver.⁷⁷ In the present context this view takes a slightly different form from the one in which it is normally presented: The causal relation is a three-place relation, involving (a) the object perceived, (b) the perceiver, and (c) the discourse referent which arises as a constituent of the content representation of the propositional attitude to which the perception gives rise and which represents the object in that representation. So, in the first two cases considered, the terms of the relation will be: (a) the stamp whose corner suggests that it is a specimen of the 2d 1840 of GB, (b) the collector, and (c) the discourse referent *x* shown in (210). Since the discourse referents at issue will always be constituents of the representations of propositional attitude contents, and the perceiver is uniquely determined as the one who has this attitude, it is legitimate to talk about the causal relation as one which involves just the perceived object and the discourse referent to which its perception gives rise; and this is the practice we will adopt.

Whether an external anchor actually exists is something for which the observer cannot have conclusive evidence – this is just what the examples of optical illusion show. In the cases we just discussed, however, the observer is persuaded that he is seeing a particular stamp – this is as true in the third case as it is in the first two. From his own, internal perspective the three cases look exactly alike. In each of them he takes himself to have direct perceptual contact with an object, and about which he then forms certain beliefs, as well as (as in the cases before us) certain other attitudes. We consider this aspect of the resulting attitude complex – that the perceiver forms a representation of something to which he takes himself to stand in direct perceptual contact – an important feature of the nature of mental representation. We capture this feature – the presumption connected with an entity representation that it is the result of a causal interaction between the one whose representation it is and that which it is presumed to represent – in terms of the notion of an *internal anchor*. Internal anchors are, unlike the external anchors we have just spoken of, constituents of the mental state of the perceiver. We represent them as separate components of the attitudinal state as a whole, on a par with those constituents that are genuine propositional attitudes.

We assume that internal anchors carry some information about how the an-

⁷⁷[References ????]

chored discourse referent anchored. Thus a perceptual anchor like the one for x in our example will contain some information which records how the perceiver perceives (or thinks he perceives) the represented object. We will not be very precise about exactly what information should go into internal anchors, leaving this as a question for further research. It should be stressed, however, that we regard perception as only one of several sources of anchoring. Other causal relations between a cognitive agent and an object can also give rise to anchored representations. And in these cases too the anchored representation may be legitimate (i.e. it did arise from an actual interpretation between the agent and the represented object) or it may be the illegitimate product of an illusory interaction, in which case there will be, once again, an internal anchor but no external one. The anchoring information that is part of such non-perceptual anchors will of course be different that which is part of the various kinds of perceptual anchors. But, as said, this is an aspect of the concept of an anchor about which we remain neutral. As an indication that we admit other anchors besides the perceptual ones, we will occasionally mark the latter with the subscript "dir. perc."

With regard to our example of the stamp box we assume that (in all three scenarios) the agent has anchored representations not only for the (presumed) stamp, but also for the box.⁷⁸

Thus we now get a total of five components instead of the three of (210).

⁷⁸The anchored discourse referent of an internal anchor is mentioned not only in the universe of the DRS that occurs as second component of the anchor, but also in the first component. This is in order to make explicit that it is this discourse referent (i.e. the one which occurs as part of the first component of the anchor) for which the anchor is an internal anchor. The DRS universe might contain additional discourse referents needed to express the anchoring information which the DRS serves to represent. In that case confusion may arise as to which discourse referent is actually being anchored. This is a complication which doesn't affect any of the examples which will be considered in this section. But it is not too difficult to come up with cases in which it does (given plausible assumptions about the information that goes into the second part of an internal anchor).

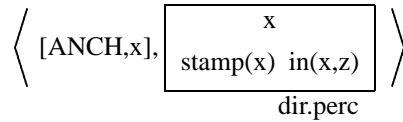
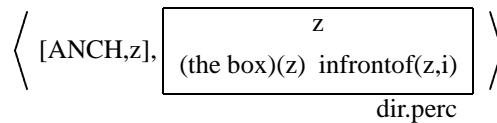

(211)

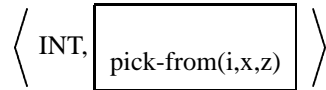
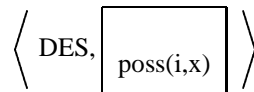
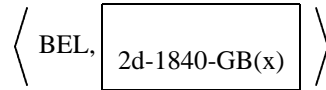

The representation in (211) leaves open whether the internally anchored discourse referents x and z are also *externally* anchored. This is information that, as noted above, cannot be part of an attitude description of which all constituents are intended to correspond to psychologically significant aspects of the represented attitude complex. It is nevertheless possible, however, for an external observer O who attributes a certain mental state to some agent A to judge that A did truly perceive a certain object, and that his representation x of that object therefore has not only an internal but also an external anchor. It should be possible for our formalism to represent such judgements. That is, it should be possible to represent the judgement that A 's representation x is externally anchored as part of O 's representation of his attribution to A . We once more use our example of the Queen Victoria stamp to show how this additional information is represented in the present framework. Suppose that (211) is O 's representation of the mental representation he attributes to A . O 's judgement that, e.g., the discourse referent x is externally anchored, is expressed in the form of a pair $\langle x, s \rangle$, where s is a designator which O uses to refer to the stamp which he assumes is the perceptual origin of A 's internally anchored representation. As indicated above, this information should be kept separate from that part of the representation which "models" A 's mental state insofar as it is accessible to A himself. So the pair $\langle x, s \rangle$ is treated as part of a distinct component, and is placed to the right of the "internal" part of the representation given in (211). (212) represents an attribution by O to A whose "psychological" component is like the representation in (211) and in which both the discourse referents x and z are

externally anchored. (Thus O also takes A's box representation z to be the result of a true perception, and uses the designator b to refer to the box which he takes A to have perceived.)

$$\begin{array}{l}
 \left\langle \left[\text{ANCH}, z \right], \begin{array}{c} z \\ \text{(the box)(z) infrontof(z,i)} \end{array} \right\rangle \\
 \text{dir.perc} \\
 \\
 \left\langle \left[\text{ANCH}, x \right], \begin{array}{c} x \\ \text{stamp(x) in(x,z)} \end{array} \right\rangle \\
 \text{dir.perc} \\
 (212) \qquad \qquad \qquad \{ \langle z, b \rangle, \langle x, s \rangle \} \\
 \left\langle \text{BEL}, \begin{array}{c} 2d-1840-GB(x) \end{array} \right\rangle \\
 \\
 \left\langle \text{DES}, \begin{array}{c} \text{poss}(i, x) \end{array} \right\rangle \\
 \\
 \left\langle \text{INT}, \begin{array}{c} \text{pick-from}(i, x, z) \end{array} \right\rangle
 \end{array}$$

The set $\{ \langle z, b \rangle, \langle x, s \rangle \}$ is called the external anchor of (212), and its member pairs $\langle z, b \rangle$ and $\langle x, s \rangle$ external anchors for z and x , respectively. If the observer O believes z to be externally anchored, but not x , then the external anchor of his description would contain the pair $\langle z, b \rangle$, but no pair for x . In the unlikely event that he thought even z to be the effect of an optical illusion, the external anchor would be empty; and so on.⁷⁹

Let us return to the purely internal representation (211). The mental state represented by (211), we said, could arise in each of the three scenarios we have described. In the first of these, where the stamp of which the collector sees a small corner is indeed a 1840 2d. of Great Britain, the discourse referent x is externally anchored and the belief involving it is true. In the second scenario we still have an external anchor for x , but the belief is now false. In the third scenario there isn't even an external anchor for x . What are we to say in this case about the belief of (211)? Is it false again? Or does its truth value depend on whether there is a specimen of the stamp somewhere in the box, or in that part of it where the collector

⁷⁹The formalism we present here does not provide for statements which deny external anchorage for a discourse referent occurring as a constituent in the described mental state. There are no principled objections, however, to extending the formalism with such means.

thought he saw such a specimen? Our position is that in this last case the represented belief is neither true nor false: Since there is no particular object to which x is directly linked, and which it could thereby be considered to represent, there is a fortiori no way to decide whether or not this putative object has a certain property. Failure of an internally anchored discourse referent to have a corresponding external anchor is a failure of presupposition, which renders the question of truth or falsity moot. representations of presuppositional attitudes which contain occurrences of discourse referents that are anchored internally but lack an external anchor, cannot be evaluated as true or false; they do not determine well-defined propositions.

This position, that attitude representations with internally but not externally anchored discourse referents do not express propositions, is connected with another one. Suppose an attitude representation contains occurrences of internally anchored discourse referents but that all those discourse referents do have corresponding external anchors too. In that case the representation does determine a well-defined proposition. But the proposition expressed is a *singular* proposition. In case the representation contains just one externally and externally anchored discourse referent, this proposition is the one which attributes to the object to which the discourse referent is externally anchored the property expressed by the remainder of the representation. In case there are two anchored discourse referents, the proposition attributes to the external anchors of these discourse referents a certain binary relation, and so on for numbers greater than two. In particular, in the case of the first two stamp scenarios the belief representation in (211) expresses the proposition that says of s that it is a specimen of the 2d 1840 of GB and the representation of the intention attributes to s , b and the perceiver himself the relation which holds between any individuals a , b and c iff c takes a out of b .

The position that external anchoring entails propositional singularity while absence of an external anchor for an internally anchored discourse referent entails failure to determine propositional content can be summarised as follows:

- If all internally anchored discourse referents that occur in the representation of a propositional attitude are externally anchored, then the representation expresses a proposition that is singular with respect to each of the external anchors for these discourse referents;
- If the representation contains an occurrence of a discourse referent that is internally but not externally anchored, then it doesn't express any proposition at all.

This position might be thought to undermine the very purpose of the proposal we are in the process of developing, viz. that different propositional attitudes can be "referentially connected" by sharing one or more discourse referents – just as this is often found with the representations of different sentences in a coherent discourse. For instance, in the example on which we have concentrated so far, we

considered two possibilities for the discourse referent x : either x is externally anchored, in which case each of the three attitude content representations in (211) defines a singular proposition on its own (that is, none of them needs any of the others to determine the proposition it expresses); or else x is not externally anchored, in which case none of these representations express a proposition.

So it looks like we are left with these two possibilities: either each of the components of the representation of an attitude complex defines a (often singular) proposition on its own, in which case the referential connections between them are mediated by external referents; or the “dependent” representations don’t have a proper propositional content, so there are no propositional contents to be connected. Are we to conclude that the internal referential dependencies illustrated in (211) are a red herring?

That would surely be the wrong conclusion. Internal referential connectedness is a psychologically real and important aspect of thought. To repeat once more, from the internal perspective of the perceiver-agent it makes no difference whether his internally anchored discourse referents are externally anchored or not. In either case his thoughts and actions will be the same. To return to our example: The agent A will make a move for the stamp which (he thinks) he has perceived, whether or not there really is a particular stamp that has caused his visual experience. The differences between the three cases solely concern the actual outcome of the action he performs. When there is a stamp he does perceive and this stamp has the properties he perceives it to have, things will work out as he expected; in the second case he will find to his disappointment that the stamp on which his action is targeted isn’t the one he thought it was; and in the third case he may come to realise that what he thought was a specimen of a certain stamp wasn’t really anything at all. But while there will be variation in the result of the action, the mental process which leads to it, as well as all or most⁸⁰ of the actual motions which the action involves, will be the same.

The conclusion can only be that an account of what people think and (try to) do must be independent of whether or not the discourse referents of their attitudes are externally anchored. What does matter is how they are internally connected. What we need, therefore, is not only a semantics for attitude descriptions which take external anchors into account, but also one in which only the internal properties of the represented mental state are taken into consideration. It is this second semantics which provides the basis for a useful theory of practical reasoning, not the first. What this second semantics, in which external anchors are ignored, is like, is another matter. One of the principal concerns of this section is to find out

⁸⁰Of course, as soon as the action leads to the agent’s discovery that the stamp is different from what he thought it was or that there was no particular stamp that he saw at all, the remainder of his action may be expected to be different from what it would have been if he had perceived a specimen of the stamp of which he thought he saw a specimen. But as soon as such a discovery is made, A ’s internal representation of the stamp will no longer be the same, but will be modified to reflect his new information. In particular, the discovery that there was no particular stamp at all will have the effect that A ’s representation for the particular stamp will be expunged.

what such a semantics could be like.

81

Attitude Attributions

There are two important features of mental states and their ascriptions which we have not yet considered. The first is the time at which the bearer of an attitude is supposed to have it. It is a crucial fact about people (and presumably certain other creatures too) that they have propositional attitudes. It is almost equally important that they can change them. People learn, part of which is that they acquire new beliefs; they forget things, they may change their agendas, i.e. their desires and intentions, and sometimes they come to realise that certain things they believed are false (a point already made). Therefore we want to be able to describe bearers of propositional attitudes not just as (timelessly) having beliefs, desires, etc. but also as coming to believe a given proposition at a certain time t , as having lost or abandoned a belief by a certain time (whether through sheer forgetfulness or by losing conviction that it is correct); and so on.

The second feature that is still missing from our representation format concerns the integration of *ascriptions* of attitudinal states into the general representation format of DRT. For instance, what would a DRS be like which combines the following bits of information: (a) that A is a stamp collector; and (b) that A has (at some particular time) the complex of attitudes represented in (212)?

We deal with these two problems – temporal dependence and integration – by one and the same representational device. It consists in introducing a special predicate, *Att*, into DRT's vocabulary. *Att* has three arguments: (i) for the individual to whom an attitude complex is attributed, (ii) for the attitude complex that is attributed to this individual and (iii) for the external anchor for this complex. Thus $\text{Att}(a, K, EA)$ says that a is in a mental state which contains the attitudes represented in K , and that EA externally anchors some or all of the internally anchored discourse referents occurring in K . We will assume that K is a set of attitude descriptions of the kind encountered in our examples: pairs $\langle \text{MOD}, K \rangle$, where MOD is a mode indicator (here: BEL, DES, INT) and K is a DRS. We refer to such sets as *Attitude Description Sets* (ADSs). As we have seen, the DRSs occurring as second members of pairs belonging to an Attitude Description Set K may contain free occurrences of discourse referents so long as these discourse referents are bound in a DRS occurring as second component of some other pair in K . External anchors are as described: pairs consisting of a discourse referent occurring in K and

⁸¹The distinction between these two kinds of semantics for attitude representations has been discussed extensively within the philosophy of mind. There one is often led to draw the distinction between *narrow content* and *wide content*. This distinction corresponds fairly closely to the semantics of attitude representations with or without external anchors: narrow content ignores external anchors whereas wide content takes them into account. The correspondence is far from perfect, however, since the distinction between *narrow content* and *wide content* glosses over the problem of referential connectedness. (See Loar ????, McGinn ????)

attitude ! attribution
attitude ! ascription

attitude ! description

attitude ! description set

a discourse referent not occurring in K . (The latter discourse referent functions as a K -external representation for the external anchor of the former.)

What DRS-conditions the predicate Att enters into depends on the DRS language to which it is added. However, if Att is to serve also representing the temporal aspects of attitude attributions, then the language we need is one capable of making predication time explicit generally – what we need is the language defined in Section (3.5). In this language the time of a given predication (that it is expressed by representing the predication as an eventuality to the effect that the predication holds and then locating this eventuality in time by adding further conditions (such as, say, “ $t \subseteq s$ ”, where s is the eventuality and t its location time).

is at or during time t that the predication holds) can be expressed by locating the state which consists in the predication holding as including t . This is the device of which we also make use here. Thus, DRS-conditions involving Att will come in the form given in (213)

(213) $s:\text{Att}(a,K,EA)$

The temporal dimension of such predications can now be expressed by relating s to some “location” time t , which can then be further specified in various ways (see Section (3.5)). For instance, the DRS which expresses that the individual represented as a is at the time n in a mental state which contains the belief, desire, intention and internal anchors of (211) as components takes the form given in (214):

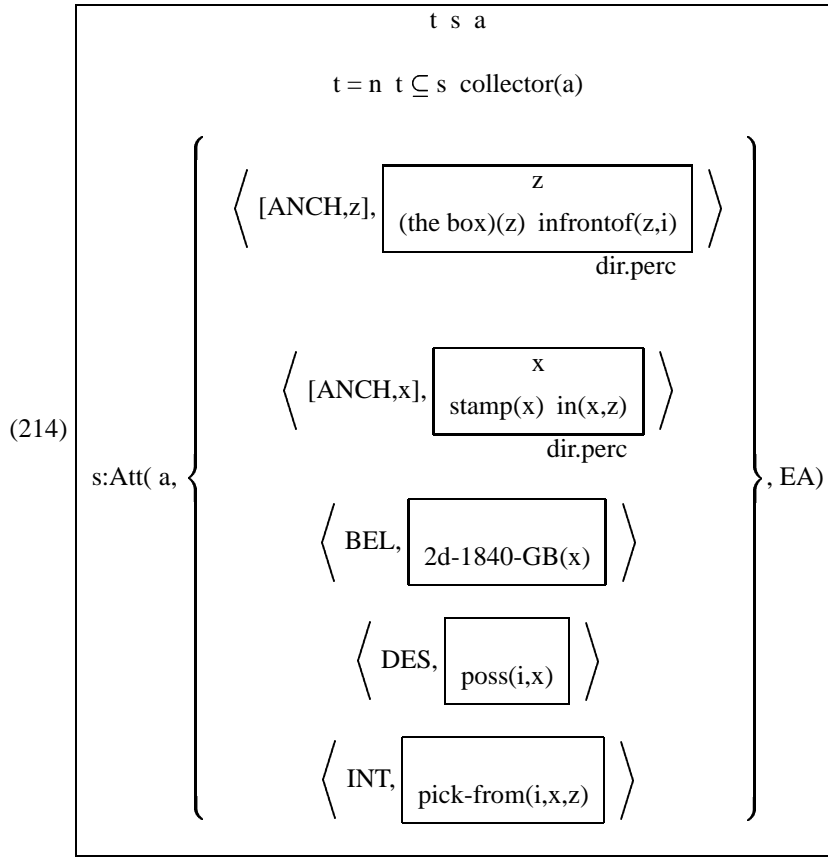

Here EA could for instance be the external anchor of (212).⁸²

It should be intuitively clear how this formalism can express more complex temporal information about attitudinal states. For instance, suppose that stamp collector A's desire to have the stamp he has spotted and his intention to pick it out of the box do not arise instantaneously, and thus not simultaneously with the belief that this stamp is a specimen of the 2d 1840 of GB, but that the belief, the desire and the intention come about at three successive times t_1 , t_2 and t_3 . Let K_1 consist of the first three components of (211), K_2 of the first four and K_3 of all five. And let EA be the external anchor given in (212). Then an approximation of the situation described is given by the following DRS (215)

$t_1 \ t_2 \ t_3 \ s_1 \ s_2 \ s_3 \ a$

(215) $t_1 < t_2 < t_3 \ t_1 \subseteq s_1 \ t_2 \subseteq s_2 \ t_3 \subseteq s_3 \ \text{collector}(a)$
 $s_1:Att(a, K_1, EA) \ s_2:Att(a, K_2, EA) \ s_3:Att(a, K_3, EA)$

⁸²N.B. When the third argument EA of Att is empty, we will usually suppress it altogether: we write "s:Att(a,K)" instead of "s:Att(a,K,∅)".

This is arguably not quite what we want, since it provides no temporal lower bound for the new attitudes. For instance, (215) doesn't exclude that A had the desire to be in possession of the stamp s already at time t_1 . The information that t_2 was the first time at which A had this desire can be expressed by adding the condition that a was not in a mental state of the type of s_2 at any time preceding t_2 . The addition would take the form given in (216)

$$(216) \neg \boxed{\begin{array}{c} t \ s \\ t < t_2 \ t \subseteq s \\ s:\text{Att}(a, K_2, EA) \end{array}}$$

This may not be the most elegant way to express such negative information, but in the formalism presented here it is the only way. A more convenient notation could be added without difficulty, if desired.

5.3 Syntax and Semantics of the Extended Formalism

Syntax

About the syntax of the extended formalism we can be brief, since all that is important has already been said.

We take the DRS-language L of Section (3.5) as our point of departure.

DEFINITION 0.62. (Syntax for DRS languages capable of describing propositional attitudes and attitudinal states).

Let L be the language defined in Section (3.5) or some extension of that language.

1. The vocabulary of the language L_{PA} is the vocabulary of L (????) together with the following two additions:

- (i) the indexical discourse referent i ;
- (ii) the predicate Att .

2. The set of DRS conditions is extended via the clause:

If s is a state discourse referent, a a discourse referent for individuals or sets thereof, K an Attitude Description Set and EA an External Anchor Description for K . Then $s:\text{Att}(a, K, EA)$ is a DRS condition.

The notions used in 0.62, that of an *Attitude Description Set* and that of an *external anchor* for such an ADS, have been described informally above. But more precise characterisations are needed. The notion of an Attitude Description Set is based on a set MI of mode indicators. In the presentation here we have opted for the set $\{\text{BEL}, \text{DES}, \text{INT}\}$, but this restriction has no direct consequences for the

definition: members of an ADS are pairs of the form $\langle \text{MOD}, K \rangle$ where $\text{MOD} \in \text{MI}$ and K is a DRS (of the new, extended language L_{PA}). The one type of element of ADSs that requires more attention is that where the first member of the pair is an expression of the form "[ANCH, ξ]", for some discourse referent ξ . Here too the second component of the pair is a DRS. As indicated above, the repertoire of conditions that occur in such a DRS should probably be restricted to conditions (or condition combinations) of special forms. This is a matter which we ignore here. But another aspect of the pairs $\langle [\text{ANCH}, \xi], K \rangle$ that can occur as members of ADSs is going to be relevant later on and needs to be stated explicitly: We assume in general that the discourse referent ξ is a member of U_K . (cf. example (212) above).

Thus we come to the first of the two supplements that are needed to turn the definition of the syntax of L into a fully explicit definition of the syntax of L_{PA} :

3. An ADS of L_{PA} is a set of pairs each of which has one of the following two forms:

- (i) $\langle \text{MOD}, K \rangle$, where $\text{MOD} \in \{\text{BEL}, \text{DES}, \text{INT}\}$ and K is a DRS of L_{PA} .
- (ii) $\langle [\text{ANCH}, \xi], K \rangle$, where ξ is a discourse referent and K is a DRS of L_{PA} such that $\xi \in U_K$.

What remains is the definition of the notion of an external anchor EA for an ADS K . But this is easy. Each ADS K has a set $\text{IA}(K)$ of internal anchors. (These are just the members of K whose first component is of the form "[ANCH, ξ "].) An external anchor for K is simply a function whose domain is a subset of $\text{IA}(K)$:

4. Let K be an ADS. An external anchor for K is a function f such that $\text{Dom}(f) \subseteq \text{IA}(K) (= \{x: \text{for some DRS } K, \langle [\text{ANCH}, x], K \rangle \in K.\})$

Semantics

The semantics for languages like L_{PA} presents us with a real quandary. The problem is a very fundamental one, and it is one which doesn't have anything to do with Dynamic Semantics as such, although one might hope that a representational approach towards semantics like that of DRT would help to find a solution for it.

The problem can be apostrophied as the gap between intentionality and intensionality. As discussed in Section (3.2), Intensional Semantics is that approach to the theory of meaning according to which notions such as "proposition", "propositional content (of an attitude)" and so on are analysed in terms of the notion of a possible world. Thus a proposition is a set of possible worlds (the set of "those worlds in which the proposition is true"), a necessary truth is a sentence or proposition that is true in all possible worlds, and similarly for other such notions. This proposal for the analysis of propositional content and of intensional sentence operators and predicates is of a piece with the thesis that it is this very notion of

attitude ! description set

intentionality
intensionality

semantics ! intensional

propositional content – which identifies propositions with sets of possible worlds – that serves as basis for the analysis of “belief contexts” (and other “attitude contexts” for other types of attitudes): the complement clauses of verbs like *believe* and other attitudinal verbs contribute to the meaning of the whole their “propositional content” in the sense under discussion (i.e. the set of possible worlds which verify the complement clause).

It is an old and often repeated observation that this cannot be right [Turner1988] [References??]. The principle that propositions, in the present, intensional sense of the term according to which they are sets of worlds, are the “objects of belief” does not do justice to the form in which the content of what is believed is available to the believer. Suppose that Bill says that he believes that there are twice as many women in his class as men and that he has expressed his belief in these very words. There are innumerable ways of expressing this proposition - that the number of women in Bill’s class is twice the number of men - in an intensionally equivalent way. Some such ways can be quite indirect, e.g. by restating the concept of one number being twice as large as another number in more esoteric mathematical terms, which require the know-how of an expert in number theory to be recognised as mathematically equivalent to the notion of multiplication by 2. And of course there is no limit to how abstruse the chosen formulations can be.⁸³ Most of these Bill – let us assume him to be a person of average mathematical knowledge and ability, though in the end the assumption matters little – will not recognise as expressing the belief to which he has just committed himself in the words mentioned. Yet they are all intensionally equivalent – i.e. they express the same propositional content, if propositional content is what the intensional approach makes it – as the words he has used himself. So if we take him by his word and attribute to him the belief which he has claimed for himself, then we are forced to say that Bill believes what each of the other sentences expresses too, notwithstanding his reluctance or refusal to accept them as true. In this manner the intensional approach calls into question one of the principal criteria that we use to determine what it is that other people believe. (And *mutatis mutandis* for determining their other attitudes, such as desire, intention, etc.).

logical omniscience

One reason why this is a fundamental problem is that it is directly connected with the question whether agents can arrive at new knowledge through ratiocination alone. We believe that it is one of the fundamental intuitions of the pure mathematician that it is possible to acquire new knowledge (and with it belief) through mathematical proof – that a mathematician who has established a surprising mathematical fact by finding a hard and non-obvious proof for it which reasons from mathematical axioms that every mathematician accepts and that he himself had been long acquainted with and never questioned, has discovered and established a new item of mathematical knowledge. However, if new knowledge can be gained through the transformation of information structures that were already

⁸³A very modest step in this direction would be to say that any set containing the number of the men and closed under the operation of forming addition will contain the number of the women.

there, without addition of any new information from outside, then evidently there is more to the form of information than the intensional approach allows for.

Accepting the verdict that seems to follow from these considerations is tantamount to condemning all intensional analyses of the propositional attitudes. This is a step that should not be taken lightly, for the intensional approach has proved immensely useful, and especially in the semantic analysis of natural language. It combines great simplicity with a degree of empirical adequacy which, although it could not be perfect (this is what the above reflections show beyond doubt), is nevertheless a striking advance over what came before it. That Montague Grammar has long been hailed – and still is by many, especially for its account of “intensional” contexts (attitude contexts prominently among them) – isn’t due to collective confusion or bewitchment. Nevertheless, the step appears inevitable.

In fact, one could not hope for a *model-theoretic* approach towards the notions of meaning and inference to come much closer to a correct analysis of propositional attitudes and attitude ascription than the intensional approach actually does. For those distinctions which the theory of propositional attitudes needs but which the intensional approach cannot supply are not distinctions in truth conditions. They concern different ways in which the same truth conditions can be expressed. A theory which does justice to this aspect of the having and handling of information must therefore include a component which deals with the possibilities of transforming one representation of information into another one (which either expresses the very same information or some part of it), and as part of this addresses the question how hard or easy it is to carry out those transformations are. In other words, such a theory must include a *proof-theoretical* component.

On the face of it the hope that DRT could help us to develop such a theory is not unreasonable. For we have seen that the content representations which DRT makes available can distinguish in at least some cases between different expressions of the same propositional intension. This, one might say, is the true moral from a cognitive point of view of Partee’s marble example (see (42), Section (3.2)), which played such a decisive part in demonstrating the importance of DRSs as a significant level of representation of linguistic information: “One of the ten marbles is not in the bag,” and “Nine of the ten marbles are in the bag,” though expressing the same propositional intension, differ nevertheless in some way that has to do with their semantics, something which is captured by the DRSs for these two sentences and which turns out to be crucial if they are followed by a statement in which the pronoun “it” is intended to refer to the missing marble.

Dynamic Semantics succeeded in recasting the distinction between these two DRSs in the form of a kind of “refined intensionality”, viz. by replacing the classical notion of a proposition – that of a set of possible worlds – by that of an information state – a set of pairs, with each pair consisting of a possible world and a “verifying embedding” which assigns objects to a certain set of discourse referents. (Definition (0.22), Section (3.2).) This refined intensionality concept, of which information states are the most salient representatives, is one step in the right direction – one step away from a classically intensional account of the attitudes and

towards an account which pays due heed to issues of form and of transformation of forms through inference. But it is only one step, and a fairly minor one at that. The more serious obstacles to a model-theoretic account of the content of propositional attitudes and the semantics of attitude descriptions are cases with which this refined notion of intensionality cannot deal any better than the classical notion. As a rule these cases have nothing to do with the availability or non-availability of discourse referents which the refined notion is able to capture while the classical notion cannot.

Whether structural properties of DRSs other than what is contained in their main universes can be used to arrive at better approximations of intensionality is a question which cannot be answered here.⁸⁴ We doubt, however, that even if such other properties should prove to be cognitively significant, they could do more than give us what would still be only a partial solution of the intensionality problem. For there is one sense in which the intensional solution seems just right: once someone has been shown that two sentences are intensionally equivalent – i.e. that they are true in the same possible worlds – he simply can no longer sincerely profess belief in what the one sentence says and refuse to profess belief in what is said by the other; and likewise with other attitudinal modes, such as intending or desire.

In the model-theoretic semantics for L_{PA} we now proceed to present the problems which necessarily beset any version of the intensional approach towards the analysis of the attitudes have been set aside. Still, the semantics does take account of complexities illustrated by the Partee example, which means that we need at a minimum model-theoretic concepts such as that of an information state (Hence the spate of definitions of such notions in Section 3.2.) However, the notions we will actually need are more complicated yet. This is connected with the form of “naive realism about propositional attitudes that is adopted in our model theory. We assume that the information which renders attitudinal conditions true in a given model are psychological facts encoded in the model which pertain to the relevant attitude bearers at the relevant times. That is, we assume that each model \mathcal{M} is equipped with a function $AS_{\mathcal{M}}$ which assigns in each possible world w of \mathcal{M} to each member a of a certain set CA_w of the universe of the model (intuitively: the Cognitive Agents of \mathcal{M} in w) at each moment of time t belonging to a certain interval or set of intervals (the period(s) of consciousness of a in \mathcal{M} in w) a certain object which identifies a 's mental state at the time in question. These objects are similar in structure to the Attitude Description Sets K which occupy the second argument position of the predicate *Att*. The values which $AS_{\mathcal{M}}$ assigns to argument combinations w, a, t are not sets of pairs each consisting of a mode indicator and a DRS, but rather sets of pairs each consisting of a mode indicator and an “intensional object definable by a DRS”. In other words, the information about attitudinal states which is incorporated in the model \mathcal{M} abstracts from the form of DRSs all but what is captured by an intensional semantics for DRSs.

⁸⁴But compare for instance [Asher1986], where the formal similarity of DRSs is used to define a new notion of propositional identity which is much stricter than the notion of an information state (and thus a fortiori than the classical notion of a proposition as a set of possible worlds).

What are the “intensional objects definable by a DRS” of which the last paragraph speaks? That will depend in the first place on what kind of intensional semantics we adopt. In the light of all that has been said about the importance of the role of discourse referents in an account of propositional attitudes the natural choice here is for the refined intensionality provided by information states – this, we take it, requires no further argumentation. However, it will not do to assume that the second members of pairs in $AS_{\mathcal{M}}(w,a,t)$ are always simply information states. Recall that one of the points of ADSs K as attitudinal state descriptions was that they may contain *improper* DRSs – these, we saw, are the natural representations of attitudes which referentially depend on other attitudes that are part of the same mental state. An improper DRS, however, does not determine an information state on its own. By itself, it only defines an *information update* (or context update), and to get an information state out of this, the information update has to be combined with the information states determined by the attitudes on which it depends. Since the concept of referential dependence within a single attitudinal state is in principle recursive – one component K_1 of the state may referentially depend on another component K_2 , which in its turn referentially depends on a component K_3 , and so on – the intensional structure of an attitudinal complex can get quite involved. The definitions below, which build on those of an information state and a Context Change Potential as defined in Section (3.2), are designed to cope with this complication. In the interest of space we will give these definitions with a minimum of elucidation.⁸⁵

The main problem that these definitions are designed to cope with are the referential dependencies of some components of a mental state on others. Suppose that the component K_1 of a given mental state depends on the components $K_{2,1}$ and $K_{2,2}$ and on no others, and that of these $K_{2,1}$ depends in turn on the components $K_{3,1}$ and $K_{3,2}$ and no others; and furthermore that $K_{2,2}$, $K_{3,1}$ and $K_{3,2}$ do not depend on any other components. Let us also assume that none of these components are internal anchors. $K_{2,2}$, $K_{3,1}$ and $K_{3,2}$ will be proper DRSs and thus each determine an information state (with respect to a given model \mathcal{M} , world w of \mathcal{M} and time t_0 of \mathcal{M}). (They also define, as explained in Section (3.2), a regular total CCP; these CCPs stand to the information states in the relation stated there.) The other two components, K_1 and $K_{2,1}$, will be improper DRSs and thus determine non-total CCPs relative to \mathcal{M} , and no information states. Note however that the CCP $\mathcal{J}_{2,1}$ determined by $K_{2,1}$, will be defined for the merge $\mathcal{I}_{3,1} \sqcup \mathcal{I}_{3,2}$ of the information states $\mathcal{I}_{3,1}$, $\mathcal{I}_{3,2}$ determined by $K_{3,1}$ and $K_{3,2}$. (The reason is that according to our assumptions the bases of $\mathcal{I}_{3,1}$ and $\mathcal{I}_{3,2}$ together cover the set of free discourse referents of $K_{2,1}$.) Let $\mathcal{I}_{2,1}$ be the result of applying $\mathcal{J}_{2,1}$ to $\mathcal{I}_{3,1} \sqcup \mathcal{I}_{3,2}$, i.e. $\mathcal{I}_{2,1} = \mathcal{J}_{2,1}(\mathcal{I}_{3,1} \sqcup \mathcal{I}_{3,2})$. The same considerations lead us to conclude that the CCP defined by K_1 will be defined for the merge $\mathcal{I}_{2,1} \sqcup \mathcal{I}_{2,2}$ (where $\mathcal{I}_{2,2}$ is the information state determined by $K_{2,2}$); so we can also associate an information

⁸⁵For more extensive comments see **Kamp (2002, 2003)** [Einstellungszustände und Einstellungsbeschreibungen in der Diskursrepräsentationstheorie] or **Kamp & Reyle (forthcoming [FDTL II])** ?????.

state, viz. $\mathcal{J}_1(\mathcal{I}_{2,1} \sqcup \mathcal{I}_{2,2})$, with K_1 .

The moral of this should be clear: By themselves the dependent components of a complex attitudinal state do not define information states; but they do so when combined with the information states determined by the components upon which they depend – provided those determine information states, something they will do so long as this is true for the components that they depend on – and so on, all the way down. This of course presupposes that by going all the way down one comes, no matter how one goes, to a well-defined end. In other words, the referential dependence relation between components of a mental state should be well-founded. So we will assume that the attitude description sets K to which the semantics described in this section assigns intuitively acceptable model-theoretic interpretations are all well-founded in the sense that the transitive closure \prec_K of the following relation \prec between the DRS components K_1 and K_2 of an ADS K is well-founded: $K_1 \prec K_2$ iff there is a discourse referent x which occurs free in K_2 and belongs to the universe of K_1 . We will from now on assume that we are dealing only with ADSs which satisfy this well-foundedness constraint.

attitude description set ! well-founded

In addition we restrict attention to ADSs K which are “proper over all” in that for each $\langle \text{MOD}, K \rangle \in K$ the set $\text{Fr}(K)$ of free discourse referents of K is included in the union of the universes of DRSs occurring in pairs $\langle \text{MOD}', K' \rangle \in K$ such that $K' \prec_K K$:

$$\text{Fr}(K) \subseteq \cup \{U_{K'} \mid (\exists \text{MOD}') \langle \text{MOD}', K' \rangle \in K \wedge K' \prec_K K\}$$

Given these assumptions about ADSs, it will be possible, given a model \mathcal{M} , a world w in \mathcal{M} and an instant of time t of \mathcal{M} , to associate with each component DRS K of an ADS K an information state $\llbracket K \rrbracket_{\mathcal{M}, w, t, K}^s$. We cannot show this yet, since we haven’t made any commitments on the form of the information given by the function $\text{AS}_{\mathcal{M}}$. But we can illustrate the general idea for simple ADSs K , in which all content specifications K (i.e. all second components of members $\langle \text{MOD}, K \rangle$ of K) are DRSs of the underlying DRS language L , in which the predicate *Att* does not occur. For the evaluation of such K the function $\text{AS}_{\mathcal{M}}$ plays no role, so we may assume that \mathcal{M} is a model for the underlying language L . First suppose that K is a content specification which has no predecessors in the order \prec_K . Then $\llbracket K \rrbracket_{\mathcal{M}, w, t, K}^s$ is simply the information state determined by K in \mathcal{M} in w at t . Secondly, suppose that we have determined information states $\llbracket K' \rrbracket_{\mathcal{M}, w, t, K}^s$ for all content specifications K' in K such that $K' \prec_K K$. By assumption the CCP $\mathcal{J}(K, \mathcal{M}, w, t, K)$ determined by K in \mathcal{M} in w at t will be defined for the merge of these information states: $\sqcup \{ \llbracket K' \rrbracket_{\mathcal{M}, w, t, K}^s : K' \prec_K K \}$.

We noted earlier that a model-theoretic analysis of when the attitude descriptions provided by ADSs are correct implies that any model \mathcal{M} must contain information about the actual attitudinal state of an agent a in a world w at a time t in terms of which ADSs can be evaluated; and we assumed that this information is supplied by the function $\text{AS}_{\mathcal{M}}$. We must now decide in which form this infor-

mation is given. We will opt for a form which makes the evaluation of ADSs in models a comparatively straightforward matter.

We proceed in two steps. We first define the notion of a P(otential) I(nformation) S(tate) B(ased) A(ttitudinal) S(tate description), and then narrow this concept down further to that of an I(nformation) S(tate) B(ased) A(ttitudinal) S(tate description).

DEFINITION 0.63. Let \mathcal{M} be a model and let $\mathcal{J}, \mathcal{J}_1, \mathcal{J}_2, \mathcal{J}'$ be CCPs:

- (i) A PISBAS *relative to* \mathcal{M} is any set of pairs $\langle \text{MOD}, \mathcal{J} \rangle$, with MOD a mode indicator and \mathcal{J} a regular CCP relative to \mathcal{M} .
- (ii) Let J be a PISBAS relative to \mathcal{M} . Let \prec_J be the transitive closure of the relation \prec between the members of J defined by: $\mathcal{J}_1 \prec \mathcal{J}_2$ iff there is a discourse referent x which belongs to $\text{PRES}(\mathcal{J}_2)$ and to a base of \mathcal{J}_1 .
- (iii) We say that a PISBAS relative to \mathcal{M} is an ISBAS *relative to* \mathcal{M} iff (i) \prec_J is well-founded and (ii) it is possible to assign, by induction along \prec_J , to each CCP \mathcal{J} occurring in J an information state $I(\mathcal{J})$ as follows: (a) Suppose that \mathcal{J} has no predecessors according to \prec_J . Then \mathcal{J} is a total CCP and the associated information state $I(\mathcal{J})$ is defined as $\mathcal{J}(\Lambda)$. (b) Suppose that for all \mathcal{J}' occurring in J such that $\mathcal{J}' \prec_J \mathcal{J}$, $I(\mathcal{J}')$ has been defined. Then \mathcal{J} is defined on $\underline{\cup}\{I(\mathcal{J}') \mid \mathcal{J}' \prec_J \mathcal{J}\}$ and $I(\mathcal{J}) = \mathcal{J}(\underline{\cup}\{I(\mathcal{J}') \mid \mathcal{J}' \prec_J \mathcal{J}\})$.

The idea behind the definition of a PISBAS is that of a structure that is essentially like that of an ASD, except that the DRSs which form the second components of the pairs $\langle \text{MOD}, K \rangle$ which occur as elements of ASDs are replaced by intensional objects (relative to the given model \mathcal{M}) of the sorts that DRSs can be used to describe. Since the DRSs occurring in ASDs are sometimes improper, these intensional objects cannot always be information states; in general they will have to be CCPs. However, when a PISBAS is an ISBAS, each of these CCPs is, roughly speaking, defined on the merge of information states that can be associated with all the CCPs on which it “referentially depends”: the $I(\mathcal{J}')$ such that $\mathcal{J}' \prec_J \mathcal{J}$ jointly fulfill the presupposition of the CCP \mathcal{J} , so that application of \mathcal{J} to their merge gives a well-defined information state, viz. $I(\mathcal{J})$. The concept of an ISBAS thus captures the idea that the contents of propositional attitudes which make up a complex attitudinal state may depend on other attitudes in the state, but that in possible worlds where the propositional contents of these other attitudes are true, the dependent attitude has a well-defined propositional content. In restricting attention to ISBASs as the possible values of the function $\text{AS}_{\mathcal{M}}$, and thus as the only possible characterisations of complex attitudinal states (of a person a in a world w at a time t) we thus impose a certain coherence condition on the mental states that, according to our model theory, it is possible for a cognitive agent to be in.

There is at least one further constraint that it seems reasonable to impose on the possible values of $\text{AS}_{\mathcal{M}}$. In our first version of the stamp example (see (211) ff.)

the desire and intention referentially depend on the belief. Such a state of affairs seems quite possible intuitively: You have a belief to the effect that a certain thing exists and then form regarding the thing you believe to exist a certain desire and/or intention. But can a belief referentially depend on a desire or an intention? We think not. On the face of it this might perhaps seem like a possibility – something of the order of wishful thinking, not to be recommended perhaps, but a cognitive possibility even so. When we look more closely, however, we realise that wishful thinking is really something else. In wishful thinking a desire may be the irrational and unjustifiable cause of a belief. But the belief won't be referentially grounded in the desire in the way in which we have seen that a desire can be referentially dependent on a belief.⁸⁶

To capture this additional constraint we need to specify the *Attitudinal Hierarchy*. This is a partial order $<_{\text{MOD}}$ between mode indicators; $\text{MOD}_1 <_{\text{MOD}} \text{MOD}_2$ means that an attitude of mode MOD_2 may referentially depend on one of mode MOD_1 . With only the three mode indicators BEL, DES, INT we would, in the light of the remarks above, assume that $\text{BEL} <_{\text{MOD}} \text{DES}$ and $\text{BEL} <_{\text{MOD}} \text{INT}$, as well as $\text{BEL} <_{\text{MOD}} \text{BEL}$ (whereas the relations $\text{DES} <_{\text{MOD}} \text{BEL}$ and $\text{INT} <_{\text{MOD}} \text{BEL}$ never hold). Whether $<_{\text{MOD}}$ should be assumed to hold also between DES and INT, however, or between INT and DES, is a more delicate question. We will not try to solve these here.⁸⁷ When further mode indicators are added, the Attitudinal Hierarchy must be extended. For instance, addition to the set {BEL,DES,INT} of the mode indicator ANCH, as shown in (210), comes with an extension of the relation $<_{\text{MOD}}$ with all pairs $\langle \text{ANCH}, \text{MOD} \rangle$ where MOD is any one of the indicators ANCH, BEL, DES, INT. More generally, richer and more refined mode indicator classifications each come with their own Attitudinal Hierarchy, and each raises its own problems about what that hierarchy is like.

We have now laid the groundwork for the truth definition that is the central purpose of this subsection. We make the general assumption that for any model \mathcal{M} , $\text{AS}_{\mathcal{M}}(a,w,t)$, if defined, is an ISBAS relative to \mathcal{M} .⁸⁸ To define truth (=proper embeddability) of DRs of our extended language L_{PA} into such models we proceed in three steps. In the remainder of this subsection we give the truth definition for that sublanguage of L_{PA} in which (i) ADSs contain no internal anchors (and in which, consequently, there are no external anchors either; thus the third argument of Att will always be the empty set and we can treat Att as a 2-place predicate); and (ii) in which there are no occurrences of *i* and of *n* within the scope of Att. In the next subsection, 5.3, we deal with the reference conditions of *i* and *n*, and in subsection 5.3 with the full language L_{PA} .

⁸⁶The belief could become in its turn the basis for the emergence of a further desire with a content which referentially depends on the belief. But the referential dependence will still be this way round, not of the belief on the first desire.

⁸⁷For discussion see **Kamp (ms)** and **Kamp & Reyle (forthc. [FDTL II])**.

⁸⁸Note well that in doing so we adopt the intensional perspective which we criticised because of its inability to deal with the logical equivalence problem. But as we already noted a refined intensional treatment of propositional attitudes is the best we can do within a framework that is purely model-theoretic.

The remaining task of this subsection is to state the verification conditions for DRS-conditions of the form “s:Att(a,K)”. In outline it should be clear what these conditions ought to be: an embedding function f verifies the condition in \mathcal{M} in w iff for each time t within the duration of $f(s)$, K is a correct description of $AS_{\mathcal{M}}(f(a),w,t)$. Given our decision about the values of AS, it should also be roughly clear how we should interpret the phrase “ K is a correct description of $AS_{\mathcal{M}}(f(a),w,t)$ ”: There must exist a map H from K to $AS_{\mathcal{M}}(f(a),w,t)$ such that for each $\langle \text{MOD}, K \rangle \in K$, the Mode of $H(\langle \text{MOD}, K \rangle)$ matches that of $\langle \text{MOD}, K \rangle$ and the content of $H(\langle \text{MOD}, K \rangle)$ matches the content of $\langle \text{MOD}, K \rangle$. But what is matching here? It is not, we contend, quite the same in the two cases. Matching of Mode should (at least for the extremely simple Mode Indicator system used here) be just what the term suggests, viz. identity: if $H(\langle \text{MOD}, K \rangle) = \langle \text{MOD}', J \rangle$, then it must be the case that $\text{MOD}' = \text{MOD}$. In connection with content, however, identity does not seem the right way to define matching. We normally regard an attitude description as correct even if it is not complete. This fact is particularly striking for the attitudinal modes of desire and intention. We can truthfully describe Mary as wanting to marry a Swede not only when her goal is as unspecific as simply “marrying a Swede” (which it would be unlikely to be), but also (more plausibly) when her idea of a suitable husband goes well beyond that: what she wants is not just any Swede, but one who is tall, blond, blue-eyed, and (of course) handsome, dashing and considerate. In other words, the content of her actual desire may be much richer than the description which we give of it. On the other hand, in order that the description is to count as correct, it must subsume the actual content.

content ! subsumption

For belief the argument that content matching should be defined as logical entailment of the described belief by the one actually held according to $AS_{\mathcal{M}}$ is not quite the same as for desire or intention, and arguably it is somewhat less persuasive. According to our own intuitions, however, belief attribution also obeys the principle of content subsumption, so we will handle matching for description components of the form $\langle \text{BEL}, K \rangle$ in the same way as those of the forms $\langle \text{DES}, K \rangle$ and $\langle \text{INT}, K \rangle$.⁸⁹

How do we capture subsumption of K by $H(\langle \text{MOD}, K \rangle)$? Suppose that $H(\langle \text{MOD}, K \rangle) = \langle \text{MOD}, \mathcal{J} \rangle$. In view of the assumptions which we have been making about ADSs on the one hand and about their model-theoretic counterparts, ISBASs, on the other, it might be thought that subsumption can be stated straightforwardly: the information state $\llbracket K \rrbracket_{\mathcal{M}, w, t, K}^s$ must be entailed, in the sense of entailment that is appropriate for information states, by the information state $I(\mathcal{J})$ which, we have seen, can be associated within the ISBAS $AS_{\mathcal{M}}(f(a), w, t)$ with the CCP \mathcal{J} ; that is, $\llbracket K \rrbracket_{\mathcal{M}, w, t, K}^s \preceq I(\mathcal{M})$.

But there is one further snag here: the discourse referents occurring in the ADS

⁸⁹Note well that the subsumption principle does not hold for all attitudinal modes. It doesn't hold, for instance, for doubt, or for “wondering”, the attitude which an agent entertains vis-a-vis a proposition p when A is unsure whether p is true and wonders whether or not it is. For attitude descriptions with richer mode repertoires the verification condition below will therefore have to be more complicated than it is for the restricted set $\{\text{BEL}, \text{DES}, \text{INT}\}$.

K need not be the same as those occurring in the bases of the CCPs of the ISBAS. Some “renaming of variables” is needed in order to make sure that the information states $\llbracket K \rrbracket_{\mathcal{M},w,t,K}^s$ and $I(\mathcal{J})$ can be related in the right way. This clearly requires that the bases of the first be included in those of the second. But of course this need not be the case, even if the attitude description provided by K is intuitively correct. For the discourse referents chosen in the actual description which K provides can be chosen freely, and will in general stand in no relation to those of the ISBAS. There are two ways to get rid of this discrepancy – either we rename the ADS or we rename the ISBAS.

For reasons which will become transparent later on we prefer the first of these options. This however runs into another difficulty, which is also connected with the formal identity of discourse referents. The ADS that needs evaluation may be part of a larger DRS in which discourse referents occur “higher up” which happen to be part also of the ISBAS. Renaming bound discourse referents from the ADS into such discourse referents could wreak havoc with the proper functioning of the truth definition and should be avoided. We eliminate this danger once and for all by assuming that the discourse referents occurring in ISBASs (including in particular all those which occur as values of the function AS_M are entirely disjoint from those which belong to the language L_{PA} .

Suppose that r is a 1-1 map from the set of discourse referents occurring in the ADS K onto some other set of discourse referents. Then the *alphabetic variant of K determined by r* is the set of all pairs $\langle \text{MOD}, r(K) \rangle$ such that $\langle \text{MOD}, K \rangle$ belongs to K together with the pairs $\langle [\text{ANCH}, r(x)], r(K) \rangle$ such that $\langle [\text{ANCH}, x], K \rangle$ belongs to K . $r(K)$ is the DRS obtained by replacing each discourse referent x occurring in K throughout K by $r(x)$.

At last we have all the pieces we need to state the verification conditions for DRS conditions of the form $s:\text{Att}(a,K)$. We get:

DEFINITION 0.64.

$f \models_{\mathcal{M},w} s:\text{Att}(a,K)$ iff there exists (i) a renaming function r such that $\text{Dom}(r)$ consists of the discourse referents occurring in K and (ii) a function H with $\text{Dom}(H) = r(K)$ such that (a) $H(\langle \text{MOD}, K \rangle)$ is of the form $\langle \text{MOD}, \mathcal{J} \rangle$, (b) for all $t \in \text{dur}(f(s))$ and each $\langle \text{MOD}, K \rangle \in r(K)$ $H(\langle \text{MOD}, K \rangle)$ belongs to $AS_{\mathcal{M}}(f(a),w,t)$ and (c) for each $\langle \text{MOD}, K \rangle \in r(K)$, $\llbracket K \rrbracket_{\mathcal{M},w,t,K}^s \preceq I(\mathcal{J})$, where $I(\mathcal{J})$ is the information state determined within $AS_{\mathcal{M}}(f(a),w,t)$ by the CCP \mathcal{J} of $H(\langle \text{MOD}, K \rangle)$.

The Indexical Discourse Referents i and n

We need two further specifications, concerning the indexical discourse referents i and n . i , we stipulated, only occurs within the scope of Att . And there it always represents the self of the cognitive agent which appears as first argument of Att . The matter of its interpretation is slightly more complicated, however, than this informal description may suggest, for some occurrences of Att may occur within the scope of others. For instance, we can express in our DRS language the state-

discourse referent ! indexical

ment that Bill thinks that Mary thought that she was clever. (More precisely, that Mary had a thought which she herself might have expressed as “I am clever.”). The condition expressing this is given in (217)

(217)

(217) has two occurrences of Att, one within the scope of the other, the first argument of the outer occurrence is the discourse referent b representing Bill, that of the inner occurrence the discourse referent m representing Mary. Clearly it is Mary whose self the occurrence of i in (217) is meant to represent. The general principle should be clear from this example: an occurrence of i represents the self of the first argument of the nearest occurrence of Att one encounters when going upwards from that occurrence in the structure of the DRS.

Formally this means, first, that the entity denoted by an occurrence of i must be evaluated within the context of this occurrence - i.e. with respect to the DRS K which contains it. And because K may well contain several occurrences of i , we need some device to distinguish these. To this end we assume that the different occurrences of i in K are indexed and use the symbol “ $i_{(j,K)}$ ” to refer to the j -th of these occurrences.

Secondly, the denotation of $i_{(j,K)}$ is determined by Definition (0.65)

DEFINITION 0.65.

$\llbracket i_{(j,K)} \rrbracket_{\mathcal{M},w,f} = f(a)$ where a is the discourse referent occupying the first argument slot of that occurrence of Att in K which contains $i_{(j,K)}$ in its scope and is within the scope of all other occurrences of Att in K with this property.⁹⁰

N.B. The way in which DRSs and their parts are semantically evaluated guarantees that by the time we “get to the given occurrence $i_{(j,K)}$ of i in K ”, the embedding function f will be defined for the relevant argument a .

The interpretation of n is determined by much the same principles as that of i : when n occurs within the scope of an occurrence of Att, then it is intended to represent the “present” of the represented thought, i.e. as representing the present

⁹⁰Denotation clauses for singular terms like that in (0.65) haven’t been considered so far, and may seem at variance with the way in which verification and truth definitions are usually formulated for DRS languages. However, the change is only a slight one. Even at this point there are only two kinds of terms to be considered, (i) “ordinary” discourse referents, any occurrences of which in proper DRSs are bound by an occurrence of the discourse referent in some DRS universe, and (ii) the two indexical discourse referents n and i . The former discourse referents will, in any normal evaluation of a proper DRS, already be in the domain of the embedding function under consideration when the question arises whether the function verifies a condition which contains such discourse referents as arguments, and the values of these discourse referents will then be whatever this function assigns to them; and the values which embedding functions assign to i and n are determined once and for all by 0.66 and 0.68 below. This fixes the values of $\llbracket \alpha \rrbracket_{\mathcal{M},w}$ for all relevant cases – both when α is an ordinary discourse referent and when it is i or n . The verification clauses for atomic conditions will now refer to the values of their argument terms. For instance, the clause for an atomic condition $P(\alpha_1, \dots, \alpha_n)$ can now be stated by referring to the values (under the embedding function f in question) of their argument terms:

$$f \models_{\mathcal{M},w} P(\alpha_1, \dots, \alpha_n) \text{ iff } \langle \llbracket \alpha_1 \rrbracket_{\mathcal{M},w,f}, \dots, \llbracket \alpha_n \rrbracket_{\mathcal{M},w,f} \rangle \in F_{\mathcal{M},w}(P).$$

from the perspective of the thinker at the time when he had that thought. That is, the occurrence should be interpreted as referring to the very same time as that of the state s characterised as “ $s:\text{Att}(a,K)$ ”, where the given occurrence of n is somewhere in K . Consider for instance the occurrence of n in (217) as part of the condition “ $n \subseteq s_3$ ”. This occurrence marks the time at which Mary has the thought which according to (217) Bill attributes to her. This is the time represented by t_2 , which according to what (217) says is in the past of the time represented by the occurrence of n in the condition “ $t_2 < n$ ”. And that time, the time of the thought of Bill, and thus of the corresponding state s_1 , is one which includes the utterance time of the entire statement represented by (217). It is easy to see that each of these occurrences of n is made to refer to the intuitively right time if we stipulate that the value assigned to an occurrence of n in K by an embedding function f is equal to $\text{dur}(f(s))$, where s is the state discourse referent such that the occurrence of n is in the condition $s: \text{Att}(\alpha, K')$ and where moreover this is the nearest condition of this form containing that occurrence.

One difference between i and n is that n is also allowed to occur outside the scope of Att . In those cases it refers to the utterance time of the represented statement. Thus the interpretation clause for n divides into two parts. (In analogy with our convention for i , we denote particular occurrences of n in K as “ $n_{(j,K)}$ ”.)

DEFINITION 0.66.

- (i) Suppose that the occurrence $n_{(j,K)}$ of n in K is within some condition of the form $s:\text{Att}(\alpha, K')$. Then

$\llbracket n_{(j,K)} \rrbracket_{\mathcal{M}, w, f} = \text{dur}(f(s_0))$, where s_0 is the discourse referent such that $n_{(j,K)}$ occurs in $s_0:\text{Att}(\alpha, K')$ in K and $s_0:\text{Att}(\alpha, K')$ is within the scope of all other conditions of this form which contain $n_{(j,K)}$.

- (ii) Suppose that the occurrence $n_{(j,K)}$ of n in K is not within any condition of the form $s: \text{Att}(\alpha, K')$. Then

$\llbracket n_{(j,K)} \rrbracket_{\mathcal{M}, w, f}$ = the “utterance time of the represented utterance (See **Section ????**)”.

Semantics for Anchored Representations

The verification definition (0.64) only covers representations in which all discourse referents are unanchored. When anchored discourse referents are taken into account, matters get a little more complicated. First, we now must distinguish between wide content and narrow content. In the case of wide content, the internal and external anchors play a part in the verification conditions, in the case of narrow content they do not.

content ! wide
content ! narrow

We start with wide content. There are two complications which do not arise with anchor-free representations. First, when a discourse referent x which is internally

anchored in an ADS K has an external anchor x' , then each DRS K such that $\langle \text{MOD}, K \rangle$ belongs to K and in which x occurs should be seen as expressing a proposition that is singular with respect to the value of x' . More precisely, in the context of evaluating the condition “ $s:\text{Att}(a, K, \text{EA})$ ” in \mathcal{M} in w at t under f the proposition expressed by K in \mathcal{M} relative to f should be singular with respect to $f(x')$. (Note that if $\langle x, x' \rangle \in \text{EA}$, then x' occurs free in “ $s:\text{Att}(a, K, \text{EA})$ ”; so if evaluation of “ $s:\text{Att}(a, K, \text{EA})$ ” in \mathcal{M} in w at t under f arises in the context of evaluating a proper DRS of L_{PA} in which the condition occurs, then x' will be in the Domain of f .) We achieve singularity of the proposition expressed by K with respect to all the internally and externally anchored discourse referents occurring in K if we evaluate the proposition expressed by K not with respect to f but with respect to the extension $f \cup (\text{EA} \circ f)$ of f which has each of these discourse referents x in its domain and assigns to x the value that f assigns to x' .

The second desideratum for the verification condition for “ $s:\text{Att}(a, K, \text{EA})$ ” is that verification is undefined when K contains discourse referents which are internally but not externally anchored. There are various ways to achieve this. A very simple one is to remove the internal anchors of such discourse referents from K . This will in particular have the effect that occurrences of the discourse referents whose anchors have been removed in other components of K will not be declared (i.e. they won't belong to any DRS universe). As always this causes indeterminacy of verification for any atomic condition which contains such a discourse referent as argument. This will then also entail indeterminacy of the verification condition for “ $s:\text{Att}(a, K, \text{EA})$ ”.

To implement this idea we must form, given an ADS K and an external anchor EA , the *Reduction of K with respect to EA* , $\text{Red}(K, \text{EA})$. This is the structure which we get by removing all internal anchors in K which aren't justified by EA , i.e. all internal anchors for discourse referents which do not occur in the Domain of EA :

DEFINITION 0.67.

$$\text{Red}(K, \text{EA}) := K \setminus \{ \langle [\text{ANCH}, x], K \rangle \mid \langle [\text{ANCH}, x], K \rangle \in K \wedge \neg (\exists x') \langle x, x' \rangle \in \text{EA} \}$$

N.B. Evidently, if all internally anchored discourse referents of K are externally anchored by EA , then $\text{Red}(K, \text{EA}) = K$.

We are now ready to state the generalisation of Definition (0.64) in the sense of wide content:

DEFINITION 0.68.

$f \models_{\mathcal{M}, w} s:\text{Att}(a, K, \text{EA})$ iff for all $t \in \text{dur}(f(s))$ there exists a function H from $\text{Red}(K, \text{EA})$ into $\text{AS}_{\mathcal{M}}(f(a), w, t)$ such that for each $\langle \text{MOD}, K \rangle \in \text{Red}(K, \text{EA})$, $\llbracket K \rrbracket_{\mathcal{M}, w, f \cup (\text{EA} \circ f), K}^s \preceq I(\mathcal{J})$, where $I(\mathcal{J})$ is the information state determined within $\text{AS}_{\mathcal{M}}(f(a), w, t)$ by the CCP \mathcal{J} of $H(\langle \text{MOD}, K \rangle)$.

Our last task in this section is to define the verification conditions of “ $s:\text{Att}(a, K, \text{EA})$ ” in the sense of narrow content. Informally speaking this amounts to ignoring

the external anchor EA and treating internally anchored discourse referents of K “existentially”. Existential interpretation of the internally anchored discourse referents can be accomplished in more than one way, with slightly different effects. One of them is to treat the internal anchors as “de dicto beliefs”, i.e. to replace each internal anchor $\langle [\text{ANCH},x],K \rangle$ in K by $\langle \text{BEL},K \rangle$, and that is the one we adopt. To this end we define, for arbitrary ADS K :

DEFINITION 0.69.

$$\text{NC}(K) = (K \setminus \{ \langle [\text{ANCH},x],K \rangle \mid \langle [\text{ANCH},x],K \rangle \in K \}) \cup \{ \langle \text{BEL},K \rangle : \langle [\text{ANCH},x],K \rangle \in K \}$$

The narrow content verification of “ $s:\text{Att}(a,K, \text{EA})$ ” can now be defined as the verification of the condition “ $s:\text{Att}(a,\text{NC}(K))$ ” in the sense of Definition (0.64).

We have argued that being in a mental state involving internally anchored discourse referents which lack an external anchor is being in a state involving unjustified presuppositions. So at least those attitudes that are part of the state and which are directly affected by the presupposition failure fail to determine well-defined propositions. Yet, we noted, the unjustified internal anchors are connected with existential beliefs whose truth conditions are well-defined, but false. In the light of the developments in this section it seems plausible that these remarks can now be made more explicit via the notion of narrow content: Given an ADS K , we obtain the associated beliefs by passing from K to $\text{NC}(K)$.

Whether this gives us precisely what we want isn’t altogether clear. For it isn’t clear that the associated beliefs will necessarily be false. Such a belief, associated with an unjustified internal anchor for the discourse referent x , might come out true if there were an object satisfying the anchor’s DRS (which is also the DRS of the belief which replaces the anchor in $\text{NC}(K)$), even though there was nothing to cause the introduction of x . Whether this is a genuine possibility depends on detailed assumptions about the conditions imposed by internal anchors. This is a matter that requires careful discussion and one that we decided to set aside in this survey.

There is however another way of associating beliefs with unjustified internal anchors. It involves a form of reflection – a thought process in which the agent reflects on his own thoughts, thereby making these into the subjects of further thoughts. The simplest form of reflection consists of nothing more than being aware that one has the thoughts one has. Reflection of this kind is possible, we take it, not only in relation to single attitudes but also to attitude complexes. Within the formalism developed in this section the capacity of self-reflection comes to this: We assume that whenever an agent A is in a mental state that can be described by means of an ADS K , A is in a position to form beliefs of the form (218)

$$(218) \left\langle \text{BEL}, \begin{array}{|l} s \ x'_1 \dots x'_n \\ n \subseteq s \\ s:\text{Att}(i,K,\text{EA}) \end{array} \right\rangle$$

(Here EA is $\{\langle x_1, x'_1 \rangle, \dots, \langle x_n, x'_n \rangle\}$, with x_1, \dots, x_n the discourse referents with internal anchors in K .)⁹¹

While most beliefs which result from this type of reflection are true in virtue of the very fact that the agent does have the attitudes which (218) says he believes he has, this is not so for those instances of (218) in which K involves unjustified internal anchors, anchors for which there is no corresponding external anchor. For the lack of an external anchor is precisely what (218) denies: cases of unjustified internal anchors are cases where the agent is mistaken about what attitudes he has.

It is also reasonable to assume that reflection can target internal anchors by themselves. (219) gives the belief resulting from such a reflection:

$$(219) \left\langle \text{BEL}, \begin{array}{c} s \ x' \\ n \subseteq s \\ s:\text{Att}(i, \{\langle [\text{ANCH}, x], K \rangle\}, \{\langle x, x' \rangle\}) \end{array} \right\rangle$$

where $\langle [\text{ANCH}, x], K \rangle$ is a correct description of one of the internal anchors belonging to A's attitudinal state at the time in question. For any internal anchor $\langle [\text{ANCH}, x], K \rangle$ of an attitudinal state described by K the belief represented in (219) is necessarily false if $\langle [\text{ANCH}, x], K \rangle$ is unjustified. Indeed, the representations in (219) seem to capture exactly the idea of the false existential beliefs lurking behind defective attitudes de re.

5.4 Construction of Representations of Attitude Attributing Sentences and Texts

The formalism described in Section (5.2) has considerable flexibility. On the one hand it allows us to represent not only referentially connected attitudinal complexes, but also successions of these in time; thus it affords representation of attitudinal change, and not just static representations of attitudinal states at one given time. On the other hand, the formalism allows for the representation of thoughts whose content is itself an attitude attribution (either to someone else or to oneself, as when one reflects on one's own thoughts). Since this representational device is recursive, it allows also for thoughts that are attributions of attributions – as for instance when I wonder what you may be thinking about me – and so on. All these different aspects are important in a wide range of applications, and in particular in the description of the attitudinal states of participants in a conversation which arise through the verbal exchanges between them and guide the successive utterances through which the conversation progresses. (Of special importance in connection with the representation of conversation are multiply iterated attitude attributions (of the type “You think that I think that you think that ...”. such attributions play an important part in human interaction generally, and they are an almost

⁹¹In addition, one might consider products of self-reflection beliefs which attribute to the x'_i some or all of the properties that are specified in the internal anchor of x_i . But these aren't needed for the present consideration.

invariable by-product of what happens when people talk face-to-face: “I have just said this and you know that I have and you know that I am aware that you know that I ...”.)

To construct representations in which the various devices of our formalism are instantiated we need an extension of the DRS construction algorithm. In fact, the problem that many of the intended applications present is that we do not only need additional DRS construction rules to supplement the construction algorithms for the underlying DRS language (i.e. rules which extend the construction algorithm for the underlying language L to one for the full language L_{PA}); we also need rules that apply to settings not considered hitherto, such as that of a conversation in which speakers take turns. This second problem is a major one in its own right, which should be addressed in some other context. In this section we will only be concerned with the first, that of extending the text processing construction algorithms discussed in earlier sections to algorithms that can handle the problems of those sentences by means of which attitude attributions are made.

Of such attitude-attributing sentences we will only consider a very small sample, in which the vehicle for attitude attribution is an “attitude attributing verb”. Examples of such verbs are *believe, know, hope, want, desire, regret, ...*⁹² Moreover, we will only look at a very small number of examples here, emphasising the problems which an extended construction algorithm will have to tackle. Our aim will be to bring to light the special problems which will have to be tackled when the construction algorithm is extended so that it covers attitude-attributing sentences of unrestricted form. But we will only give informal hints of how the solutions might go, sketching some of the additional construction principles that will be needed but without stating an extension explicitly. For further details we must refer the reader to **Kamp & Reyle (forthc.)**.

A first and Simple Case of Interpretation Using Secondary Context

We start with an example that may be familiar to many. It was first discussed by **Stalnaker in (1988) [R. Stalnaker, Belief Attribution and Context. In: Grimm, R & D. Merrill (eds.) Contents of Thought. University of Arizona Press, 1988. See also the comments following this paper. (Kamp, 1988)]** It consists of two sentences:

(220) Phoebe believes that a man has broken into her garden. She thinks that he has stolen her prize zucchini.

Stalnaker’s principal concern in connection with this example was to show how earlier belief attributions in a discourse can serve as contexts for the interpretation

⁹²There has been a tendency in the philosophical and also in the linguistic literature to restrict the discussion of attitude attributions to sentences of this kind. But the repertoire natural languages make available for such purposes is much richer, including nouns such as *rumour, thought, opinion* or *fact*, adjectives such as *suspected* or *alleged*, prepositions such as *according to*. It is true that for many of the basic issues which attitude attributions raise the exclusive focussing on verbs is not a problem. But from a linguistic perspective such a narrow focus seems nevertheless arteficial and provincial.

of attributions made in subsequent sentences. (He calls such contexts “secondary contexts”, to distinguish them from the “primary context” of a given utterance, which contains information about the ways of the world that the utterance as a whole is about.) In the case of (220) the first sentence will enrich the primary context with the information that Phoebe believes that a man has broken into her garden. At the same time the sentence introduces a secondary context, viz. Phoebe’s “current belief context”, which is to the effect that a man broke into Phoebe’s garden. The point of the secondary context is that it can serve the interpretation of cross-sentential devices (such as anaphoric pronouns) occurring in the complement sentences of following attitude attributions, in much the same way that primary contexts serve this purpose for occurrences of those devices when they occur outside the complements of attitudinal predicates.

Where there are two or more contexts to choose from, it is to be expected that the options for presupposition justification increase. And indeed they do. However, the addition of interpretational possibilities is much more dramatic than the availability of several justification contexts might have suggested by itself. In particular, both pronouns and definite descriptions occurring in the complements of attitudinal verbs and *verba dicendi* come with a much wider repertoire of possible interpretation strategies than they do when they do not occur within the scope of such verbs. (Actually this is a more general phenomenon, which holds for a much wider range of expressions than just pronouns and descriptions, but we will explore it here only in connection with these.) To our knowledge the details of this problem have not been very systematically investigated, and our own observations here are of an exploratory character. Nevertheless they will keep us occupied for some time. Even the discussion of the seemingly simple (220), with which we begin our exploration and which illustrates only some of the issues that will preoccupy us in this final part of the present section, will take longer than might have been expected.

In the representation format we have developed in this chapter secondary contexts are identifiable as the second arguments of the DRT predicate Att. To see what this comes to in the case of (220) let us assume without further argument that its first sentence gets the representation given in (221).⁹³

⁹³We have made the plausible assumption that Phoebe has an internally and externally anchored representation for her garden. The discourse referent g serves as external representation of the object to which her representation g' of her garden is anchored. We have also assumed that it is part of the internal anchoring information connected with this internal anchor that the object represented by g' is “understood” by Phoebe as her garden. What other information the anchor contains – e.g. whether it is perceptual, based on memory or whatever – our representation leaves open; nothing in (220) indicates what this information might be like and there is no need for it to be made explicit. (In fact, with familiar objects, such as your own garden, your cat, your lover, your bed, etc. the notion of an anchor needs further scrutiny. Such objects do not have a single anchor, but an indefinite bunch of them, with each new contact between agent and object extending the bunch with a further component. It might be held that after only a little while the anchors within such a bunch blend into a single “super anchor”. For current purposes such super anchors play the same role as anchors based on single encounters, so we refrain from pursuing the differences.) Note that the possession relation between Phoebe’s garden and Phoebe is represented differently in relation to g' and in relation to g . The external description of

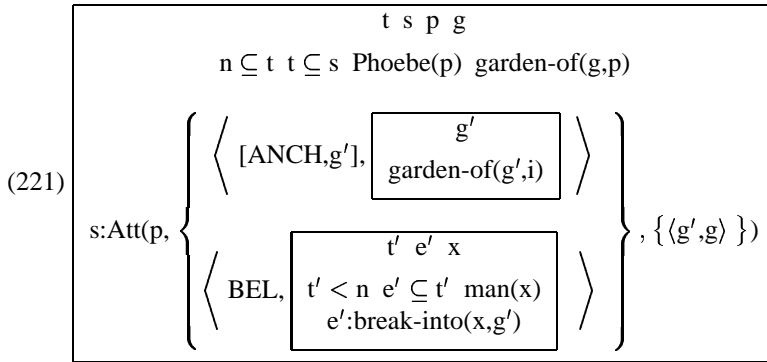

The preliminary representation of the second sentence of (220) is given in (222)

the object represented by g as Phoebe's garden makes use of the external representation p for Phoebe, whereas the internal representation of this information, as part of the internal anchor for Phoebe's own representation of her garden makes use of the indexical discourse referent i. We will return to this point when discussing the interpretation of the description "her prize zucchini", which is part of the second sentence of (220).

A further question that can be asked in connection with (221) is this: should we assume that Phoebe's representation of what the report describes with the NP *a man* is anchored too, either just internally or else both internally and externally? The case we are thinking of is one in which the reported beliefs of Phoebe's are a figment of her imagination, and that there is no particular man to whom her entity representation x can be seen as externally anchored. This still leaves open two possibilities: (i) that x is internally (though not externally) anchored; (ii) that x is not anchored at all. In (221) we have assumed that there is neither an external nor an internal anchor, but for the point that the example is meant to illustrate here it is not important how the question is settled. It would be of importance if we assumed that only anchored discourse referents can serve as the antecedents of subsequent pronouns. (Cf. e.g. Van Rooy [diss. ?????]).

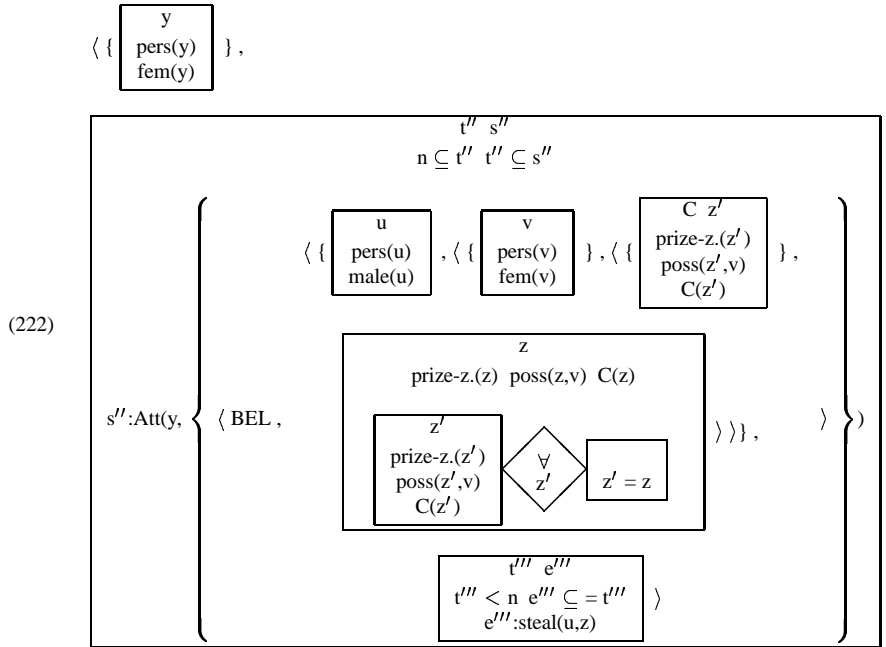

This preliminary representation has five presuppositions. The first of these, triggered by the pronoun *she*, is adjoined to the DRS for the entire sentence. In addition, there are four other presuppositions, which are adjoined to the representation of the complement clause of *thinks*. Three of these are triggered by NPs: the pronoun *he*, the definite description *her prize zucchini* and the pronoun *her* inside it; the fourth is the presupposition on the contextual restrictor C for the existence-and-uniqueness condition from the presupposition triggered by the definite description (See **Section ????**, Ch.of HPL on Presupposition). The presuppositions triggered by *her* and C are subordinate to the one triggered by *her prize zucchini*.

she. The presupposition for *she* can be resolved in the “primary” context provided by (221). (The secondary context is not available in this case, see below.) This means that only the discourse referents in the main universe of (221) are potential antecedents for the discourse referent y representing *she*. Resolution follows the pattern described in **Section 2 of Ch. ???? [Ch. on Presupposition]** and needs no further comment.

Resolution of the presuppositions adjoined to the representation of the complement is possible in principle both with respect to the primary and to the secondary context. We will take these possibilities in turn. But first we must address a general question concerning the role of the secondary context in presupposition resolution. This point will also be important in connection with the next two examples, which will be discussed in the following two subsections.

In order that the representation K' of the contents of a mental state can serve as interpretation context for the complement of an attitude attributing sentence S , it must be possible to see the attitude as a further component of the mental state which K' (partially) represents. This entails (i) that the agent to whom the attitude is attributed is the same as the agent of the mental state, and (ii) that the attitude is attributed to the agent at a time when he is in the mental state represented by K' : mental state and attitude must be simultaneous. In the case at hand the mental state is given as consisting of just one belief, represented by the DRS K' which occurs as second component in the second argument $\{\langle \text{BEL}, K' \rangle\}$ of Att in (221). That the agent of the attribution made by the second sentence of (220) is the same as the agent of this belief follows when y is resolved to p . Simultaneity of attribution and context belief rests on the fact that both sentences of (220) are in the present tense. Thus both t and t'' must include the speech time n of (220). (As it stands, this doesn't strictly speaking entail that $t'' = t$. What it does entail is that there exists a time t'' during which the attribution made by the second sentence holds, which includes n and is included in t . But that seems enough to capture the content of (220).⁹⁴)

Having identified y with p and t' with t we have made the DRS of the complement clause of (221) available for resolution of the remaining presuppositions of (222). But this doesn't *by itself* answer the question how these presuppositions are to be resolved. This is true in particular of the three remaining NP presuppositions. In fact, we will see that each of these raises its own problems.

he. The least problematic is the anaphoric presupposition triggered by *he*. Now that we have secured the belief representation in (221) as (secondary) context for the interpretation of the complement of the second sentence of (220), the discourse referents in the universe of that representation are available as possible antecedents for the discourse referent u representing *he*. The obvious choice is x . So we resolve the presupposition by identifying u with x . **(N.B this solves the problem with which the paper of Stalnaker in [Grimm & Merrill. Contents of Thought] and the comments by Kamp in that volume were principally concerned.)**

her. Next, we turn to the possessive pronoun *her* of the definite description *her prize zucchini*. Intuitively it seems clear that this presupposition should be resolved by identifying the discourse referent v which represents *her* with the discourse referent p of the primary context. But such identifications come with a complication. By identifying the discourse referent v with one that is bound inside the main DRS we turn the propositional content of the attributed attitude into a singular

⁹⁴The possibility of identifying t' with t would be a consequence of treating present tense sentences as having an anaphoric dimension: apart from the requirement that the location time of the described eventuality include n , such a treatment would create the possibility of identifying this location time with some other time t which also includes n and which has already been introduced into the context. We will not elaborate this treatment further here. For the anaphoric dimension of tense see Section (3.5).

proposition. In fact, the link between the discourse referent originating within the representation of the attributed content and the one bound outside this representation can be seen as an external anchor for the former. According to the position adopted in Section 5.3 this is coherent only if the internal discourse referent is internally anchored as well as externally. Thus, if we stick to the principle that there can be no external anchor without an internal anchor, then we must assume that by resolving *v* through identification with an external discourse referent, the interpreter is committed to the assumption that there is an internal anchor for *v*.

In cases where the external discourse referent with which the internal discourse referent *v* is identified represents an individual distinct from the agent of the attitude to whose representation *v* is internal, what was said in the last paragraph is all that needs to be said. But the situation has an additional complexity when the external discourse referent represents the agent. In this case it is also possible to interpret the internal discourse referent through identification with the external one. In the example we are discussing this amounts to identifying *v* with *p* – or, more fully, to taking *v* to be internally anchored and externally anchored to *p*. Note however that while the result of this is a representation of a belief of Phoebe's that is *de re* with respect to Phoebe herself, it is only one of two ways in which the pronoun *her* can be interpreted as referring to Phoebe.

The other possibility is to interpret *her* as signalling reference to Phoebe's self from her own internal perspective. We discussed self-reference in thought of this type in Section 5.3 and there we decided to represent it with the help of the special indexical discourse referent *i*. In line with that decision, the interpretation of which we are speaking now should involve identification of the discourse referent *v* with *i*. When a pronoun (or its representing discourse referent) is interpreted in this way, however, then there is of course no need for further assumptions about internal or external anchors. (For any occurrence of *i* is itself internal and, because of its direct link with the agent, it can be considered to have both an internal and an "external" anchor no matter what.) Below we will display both the *de se* and the *de re* interpretation of *her*.

her prize zucchini. The difference between the *de re* and the *de se* interpretation of *her* has its repercussions for that of the NP *her prize zucchini* which contains it. Let us begin with the assumption that *her* is given a *de re* interpretation. In that case there are still two options for the justification of the existence-and-uniqueness presupposition: either at the level of the secondary context or at that of the primary one. The first option amounts to assuming (i.e. accommodating the assumption) that Phoebe takes it that there is a unique entity *x* which is a garden, satisfies some additional predicate *C* and stands in the relation of being "had" by the person *v* of whom she has some anchored representation (which happens to be Phoebe). The second option amounts to there being a unique entity that is a garden, satisfies *C* and stands in the "being had" relation to the individual represented by *p*, i.e. to Phoebe. A further effect of this second option is that the discourse referent *z* which

represents the denotation of the description moves to a position that is external to the representation of the belief. Once again this entails, in the light of our earlier assumptions about external and internal anchors, that there must be an internally anchored discourse referent that stands within the belief representation and that is externally anchored to z .

C. Let us, before we go on, display the representations to which these interpretational decisions lead. To do so, we also need to make a decision about the interpretation of C , but in connection with the example before us this is a matter that can be dealt with straightforwardly: the predicate “is a’s garden” is uniquely satisfied for many values of a . If we are prepared to suppose that this is the case in particular for Phoebe, then the default interpretation of C as the universal predicate will serve. Let us assume that this is the way in which C in (221) gets resolved. Since this resolution makes the predications involving C vacuous, they will be dropped in the final representations of (220) that will be displayed below.

Both (223) and (224) assume the *de re* interpretation of *her*. (223) gives the internal accommodation of the existence-and-uniqueness presupposition of *her prize zucchini*, (224) its external accommodation. Both representations give the merge of the new representation with (221). For easier reading we have kept the two components of the merge graphically separate.

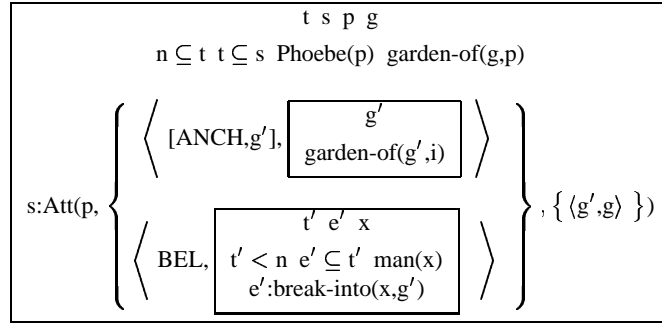

(223)

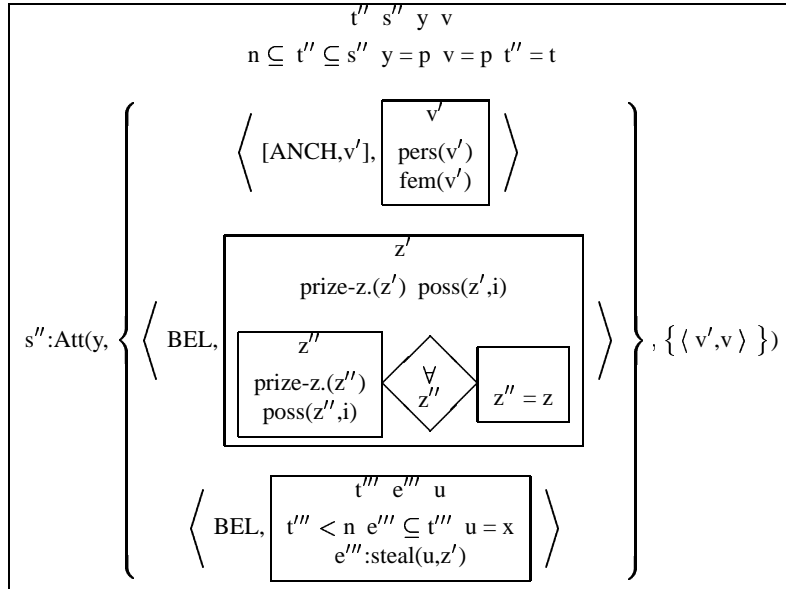

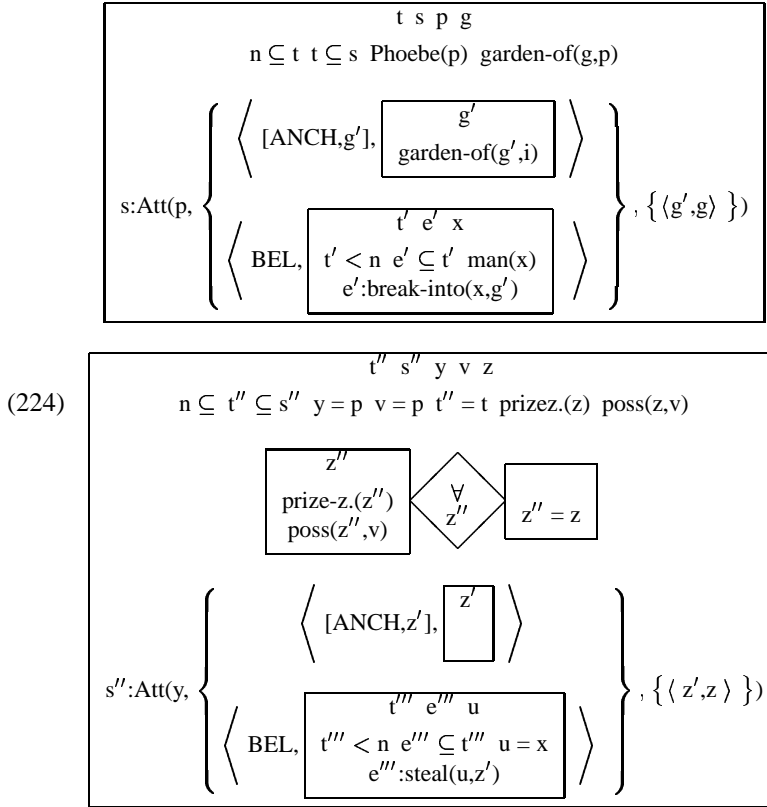

t'' s'' y v z

$n \subseteq t'' \subseteq s''$ y = p v = p t'' = t prizez.(z) poss(z,v)

z''

prize-z.(z'')

poss(z'',v)

∀ z''

z'' = z

s'':Att(y,

{

⟨

[ANCH,z'],

z'

⟩

⟨

BEL,

t''' e''' u

⟩

}, { (z',z) })

Note that in (224) there is no internal anchor for the referent of the pronoun *her*. The “external” interpretation of the definite description *her prize zucchini* which (224) represents allows for a purely external representation of *her*; only the discourse referent *z* for the entity denoted by the expression as a whole enters (indirectly via *z'*) into the content representation of the belief that the second sentence attributes.

The official notation in which these last two representations are given has the merit of making the distinction between internal and external anchors explicit. But it is cumbersome, and now that we have repeatedly demonstrated how it works, the time is ripe for simplifying it. We simplify by adopting the very notation against which we warned above: the one in which a discourse referent which is bound in a position external to

Att'' occurs as an argument in one or more DRS-conditions which are within the scope of this occurrence. The use of this notation is now to be understood, however, as shorthand for the more complex one which appears in (223) and (224):

convention ! notational

NOTATIONAL CONVENTION 0.70. Externally Bound Discourse Referents

If a condition P(w) is part of the representation K of an attitude content and w is bound outside the Att-condition of which K is an immediate constituent – i.e.

N.B We have adopted in this representation the convention of replacing the discourse referent v for *her* everywhere by i rather than link it to i via the condition “ $v=i$ ”.

The representations (223) – (226) may seem to present us with a problem in that none of them seem to fully capture the interpretation which a normal speaker is likely to understand the definite description of the second sentence of (220): as an NP that is to be interpreted *de re*, while the pronoun *her* that it contains is given a *de se* interpretation. None of the representations we have given shows this combination.

This doesn't mean that a representation with these properties would be incompatible with the principles we have formulated so far. For one thing, the representations which we have shown are to be understood as minimal, in the sense that the information they contain must obtain if the represented sentence (on its given interpretation) is to be true. They do not exclude the possibility that the interpreter's representation gets further enriched on the strength of various “pragmatic” considerations, which go beyond that which is conveyed by linguistic form as such. In the present case, however, it might even be argued that the interpretation that we are looking for is the result of yet another way of interpreting the definite description *her prize zucchini*, according to which it has a double function - – first as a means of identifying the external anchor of an internally anchored representation of the agent Phoebe, and secondly as a description of the information which she herself uses to represent the referent; it is in this second capacity that the description allows - and suggests - a *de se* interpretation of *her*, while it is the first function which makes the belief *de re* with respect to the zucchini. (227) gives the representation which results if the description is taken to play this double role. As (227) shows, the processing rule which reflects the double role interpretation of the NP must produce the effect that the internally anchored discourse referent introduced by the “internal” interpretation of the NP is externally anchored to the discourse referent established by its *de re* interpretation. In the simplified notation used in (227) this means that the conditions yielded by the internal interpretation take the form of predications of the external anchor

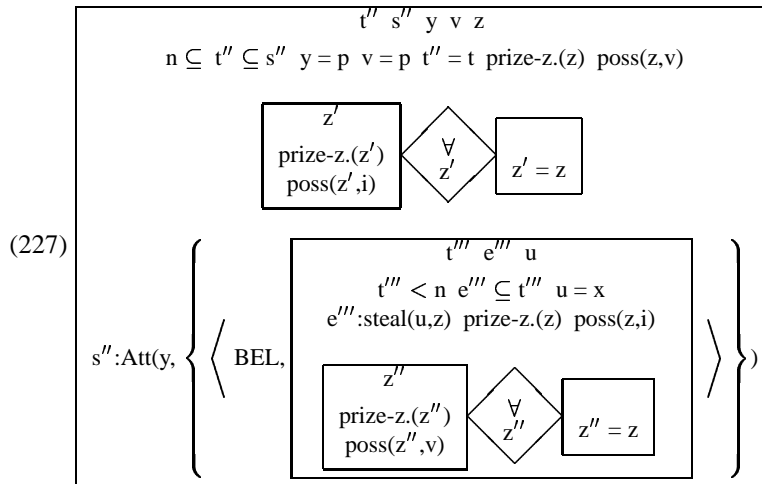

Summary of 5.4: Our discussion of example (220) has focused on two aspects of the interpretation of attitude attribution sentences. First – this is a very general point, which will play a major role in the examples considered in the next two sections – in order that representations of mental states in the context in which such a report is interpreted can serve as “secondary contexts”, it must be established that they represent mental states of the agent to whom the report attributes a state and moreover that they hold at the time at which the agent has this attitude according to the report.

The second point, to which most of the discussion of this section has been devoted, concerned the multiplicity of possible interpretations for certain NPs which arise when the NP is part of the complement clause of an attitudinal predicate (such as, in our example, the verbs *believe* and *think*). Although we haven’t explicitly stated the interpretation (= DRS construction) rules for NPs which cover these new possibilities, we trust that the discussion has given a fairly clear indication how rules could be stated which lead to the representations we have shown. Now that we have seen in some detail to what multiplicity of alternative interpretation rules pronouns and definite descriptions give rise when they occur in the scope of attitude predicates, it is well to reiterate our earlier observation that this dramatic increase in interpretational options is by no means limited to just these two types of expressions. WE find a comparable increase for other NP types that have anaphoric uses (such as demonstrative NPs), as well as – and this is particularly important – for indefinite NPs. (It is an old observation about indefinite NPs in the complements of attitude predicates like “believe” that they usually allow for a “*de re*” as well as a “*de dicto*” interpretation. The *de re* option can be seen as one way in which indefinite NPs can be “specific”.) Moreover, new interpretational distinctions also arise for types of expressions other than NPs. for these reasons extending the construction algorithm for a language fragment without attitude predicates to

one which includes them is a complicated matter, which requires careful analyses of what ranges of representations are possible for which sentences.

In the next two sections we consider examples which illustrate two further aspects of the representational capacities of our formalism and of the interpretational principles needed to interpret sentences and discourses which make use of these possibilities. The example of the next section concerns the description of attitudinal change, i.e. of a temporal succession of distinct mental states of the same agent. The section after that is devoted to a case in which attitudes are attributed to two different agents who can be assumed to share a certain common ground. Such a common ground will often make it possible to use an attribution that has been made to one of them as context for the interpretation of an attribution that is made subsequently to the other.

attitude ! change

common ground

Reporting Changes of Attitudinal States

The next example illustrates the ability of the present formalism to accurately represent temporal relations between the times at which attitudes are entertained and the times of the eventualities mentioned in the propositional contents of those attitudes.

(228) On Sunday Bill heard that Mary was in Paris. On Tuesday he learned that on the previous day she had left.

(228) also exemplifies some of the complexities that arise in connection with the interpretation of tenses and other expressions referring to time; these, we will see, have much to do with the way in which the temporal aspects of the contents of thoughts are connected with the times at which they are entertained.

The first instance of this problem that we must consider here is the past tense in the complement of *heard* in the first sentence of (228). It is a well-known and much discussed fact of languages like English that a simple past tense within the complement of an attitudinal verb which itself is also in a past tense can be understood as expressing simultaneity between the eventuality of the complement and the attitude or attitudinal change referred to by the verb itself – a phenomenon known in the literature as “sequence of tense”. This is not the only possible interpretation for the past tenses of verbs in the complements of past tense attitude verbs or *verba dicendi*; they can also be understood as expressing anteriority to the time of the matrix verb eventuality. Thus the first sentence of (228) can be understood not only as saying that what Bill came to believe on Sunday was that Mary was in Paris at the very time he had just formed this new belief, but also that what he came to believe was that she was in Paris at some time before that when his new belief came about. How the tense of the complement is interpreted will depend on several factors, one of which is the Aktionsart of the embedded verb. If this is an event verb, then in English the simultaneous (i. e. sequence of tense) interpretation is excluded. (For the same reason that the use of the simple

sequence of tense

Aktionsart

present is proscribed in normal context. However, the simultaneous reading returns as a possibility when the simple past is replaced by a past progressive, just as present progressives of event verbs are acceptable in normal contexts.) When the embedded verb is stative, then its simple past will in general be ambiguous between the simultaneous interpretation and the anterior interpretation. (When the verb phrase of the complement sentence is stative, there is usually a preference for the simultaneous interpretation.) We choose the simultaneous interpretation for the first sentence as the basis for the interpretation of the second sentence, which is the real topic of this subsection. (See (229), (230) below).

How do we represent the simultaneous interpretation? For the most part this should be clear from what has been said about the representation of propositional attitudes so far. In particular, simultaneity of the content of a thought with the time when the thought is being entertained can be expressed with the help of the temporal indexical *n*. In other words, the state of Mary's being in Paris is to be represented as surrounding the "internal present" which is denoted by an occurrence of *n* within the representation of Bill's attitudinal state. As the sentence makes clear, this attitudinal state is temporally located within the interval denoted by *Sunday*. (See Section (3.5) for details.)

New in the representational challenge which the first sentence of (228) presents is the representation of the verb *hear*. Like the verb *learn* of the second sentence, *hear*, in the use that is made of it in (228), conveys the emergence of a new belief (or item of knowledge), where just before there wasn't such a belief (or perhaps even a contrary opinion). It is arguable that this bit of information, which is unequivocally part of the meaning of *learn*, is only an implicature in the case of *hear*. But we will leave this question – whether we are dealing with an implicature or a genuine part of the lexical meaning – for some other occasion, and assume for simplicity that there is a lexical meaning of *hear* which does include the previous non-existence of the belief as a component, just as this is the case for *learn*. (We also ignore that *hear*, as opposed to *learn*, carries implications about the way in which the information reaches the agent – for instance, hearing is not the same as (learning by) reading.) We also pass over the question whether "x heard that p" really entails that x came to believe that p. Perhaps Bill heard that Mary was in Paris, but didn't believe a word of it? In the context of (228), where the second sentence seems to refer back to the attitudinal state which has been set up by the first, this second possibility seems more remote than it may be in other contexts, and so it too is set aside.

The relevant reading of *hear*, then, which we assume to be the one relevant to the present sentence is that of a change-of-state verb, which expresses a transition from the state of not believing/knowing the content of what one hears to the state in which one does believe/know that. We also make the usual assumption about pre-states of change-of-state verbs, viz. that such verbs carry a presupposition to the effect that a pre-state of the relevant type (one which denies the type of the result

state) obtains at the time when the venetuality described by the verb begins.⁹⁵

We are now ready to present the representation of the first sentence of (228). (229) gives the preliminary representation for this sentence, with explicit and separate representations of the presuppositions triggered by the proper names *Sunday*, *Bill*, *Mary* and *Paris* and the pre-state presupposition of *hear*. In the final representation (230) for the sentence all five presuppositions have been accommodated.

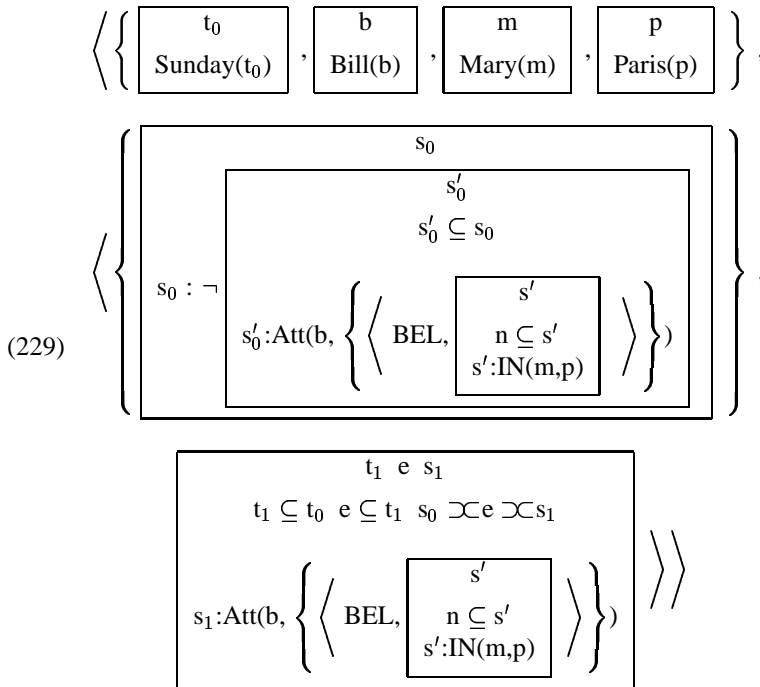

⁹⁵There is one further issue connected with the first sentence of (228) which we must briefly comment on before showing the representation which we will use as context for the interpretation of the second sentence. This issue concerns the representation of the names *Mary* and *Paris*. It doesn't have to do with the temporal aspects of (228) as such and we would have raised it in connection with our last example if that had happened to contain a proper name within an attitudinal complement. Occurrences of names within the complements of attitude verbs and dicendi verbs are typically understood as de re. (There may be marginal exceptions to this, but if we are right, then these really are marginal.) This means that the reported belief must be construed as involving discourse referents which are externally anchored to the person Mary and the city of Paris, respectively.

We assume that the same is true for the NP *Sunday*. Weekday names aren't proper names in the sense of having all properties that semanticists and philosophers of language take to be part of the concept of a proper name. In particular, the denotations of weekday names depend in systematic ways on the contexts in which they are used. We will ignore this contextual dimension of the reference of *Sunday* here. (No information about the context was given anyway. We will take *Sunday* in (228) to refer the last Sunday before the utterance time, but nothing much hangs on this.) What is more relevant to what will be said about the interpretation of (228) below is the temporal relation between the referents of *Sunday* in the first sentence and *Tuesday* in the second. We will assume that *Tuesday* refers to the Tuesday immediately after the referent of *Sunday* in the first sentence.

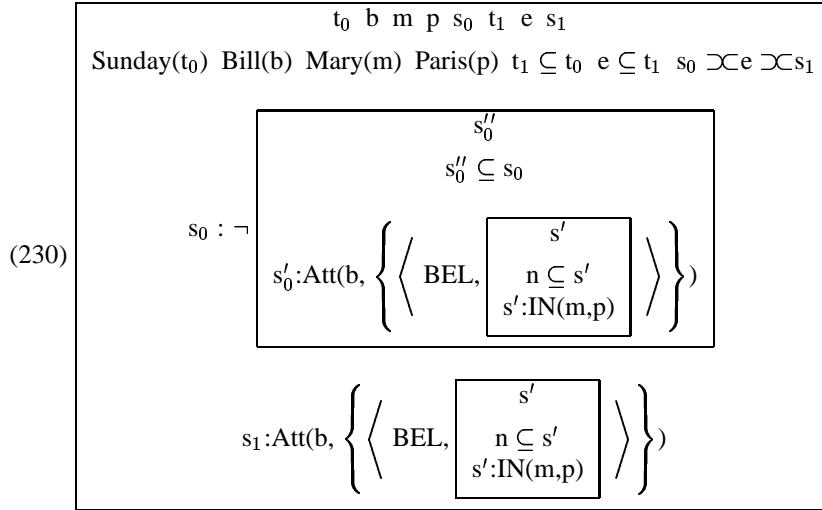

(Here “⋈” denotes abutment of two eventualities or the periods (see Section (3.5)). Note the somewhat cumbersome way of expressing the information that Bill’s belief that Mary is in Paris is new: the event *e* contributed by *hear* is represented as the transition to a post-state *s*₁ in which Bill has a belief to the effect Mary is in Paris from the pre-state *s*₀ in which Bill’s attitudes do not include such a belief. We will discuss the representation of state transitions at length in Section 6.

We now pass to the central concern of this subsection: the interpretation of the second sentence of (228) in the light of the context established by the first sentence (230). We split the discussion of the issues which need addressing into two parts, (i) the conditions that must be satisfied in order that the secondary context provided by the belief attribution of the first sentence can be used in the interpretation of the second sentence, and (ii) some of the complexities that arise in connection with the interpretation of certain constituents of the complement of the second sentence, given that both the primary and the secondary context are available for the resolution of presuppositions.

Temporal Alignment of the Secondary Context with the Attitude Report.

The second sentence of (228) is in many ways like the first. But there is one crucial difference, and this is our principal reason for making (228) the topic of a separate discussion: as in our previous example (220), interpreting the complement of the matrix verb of the second sentence – here the verb *learn* – requires as context the representation provided by the complement sentence of the first sentence. As we noted in connection with (220) using one attitude attribution as context for another presupposes that the two attitudes must be part of a single attitudinal state. This entails that we must be dealing (i) with a single attitude bearer, and (ii) with a single time at which both attitudes are entertained. In our first example (220)

verifying that these conditions were fulfilled was straightforward. Here it is not.

Note that what the first sentence of (228) tells us is just that Bill acquired a certain belief on Sunday. We are not told whether he kept this belief – that Mary was in Paris during some period including the time when he heard that she was in Paris – until the time on Tuesday, when he is said to have learned that she “left”. Yet we must assume that he did, for otherwise it is hard to make sense of the belief attribution that is made in the second sentence: the intransitive verb *leave* always involves, from a semantic point of view, an argument for the place from which the subject leaves, irrespective of whether this place is mentioned explicitly (in the form of a *from*-PP) or not. Moreover, when the place is not mentioned explicitly, there is always an implication that it can be reconstructed from context.

In the case of (228) the resolution of this instance of “implicit argument anaphora” is intuitively clear: it seems clear that the place of which Bill learns that Mary left from there was Paris. Since a discourse referent representing Paris is present in the primary context that is given by (230), this resolution does not require the secondary context. But *leave* also comes with a pre-state presupposition, viz., that its subject was in the place that she is said to have left. In principle, pre-state presuppositions are quite easily accommodated, but nevertheless the use of *leave* (like that of other change-of-state verbs) creates a definite presumption of the relevant pre-state being “already known” – that is, part of the context. In the case at hand this means that there is a presumption that the pre-state – that of Mary being in Paris – is “already known” to Bill. The context provided by (230) supports this presumption, in that the obtaining of this pre-state is the content of its secondary context. However, the secondary context of (230) can resolve the pre-state presupposition triggered by *leave* only when it is assumed that the belief which (230) attributes to Bill continues to be his belief until the time on Tuesday when he finds out about Mary’s departure. That this is really so cannot be strictly inferred from (230), but must be accommodated. It is the kind of accommodation that comes easily, since it is in line with a general principle of discourse “persistence”: states of affairs which the discourse claims to obtain at some given time will typically be assumed to persist unless the discourse provides explicit or implicit information to the effect that the state has come to an end.⁹⁶ Nevertheless, it is an accommodation of some kind.

The next question we must address is what exactly is being accommodated. This may seem a strange question, with an answer that is entirely obvious: we simply add a condition that the state s_1 of (230) still holds at the time of the event e' of Bill learning that Mary has left Paris. But there is a subtlety here. It is

⁹⁶This principle, also called “monotonicity” (see Reyle & Rosseideutscher (2001) [Reyle, U. & A. Rosseideutscher Temporal Underspecification in Discourse. In: Rohrer, Ch., A. Rosseideutscher & H. Kamp (eds.) Linguistic Form and its Interpretation CSLI]) is reminiscent of the frame problem from AI. But the discourse effect tends to be even stronger, for it is a constraint on discourse coherence that the termination of such states must be conveyed, if this is what the speaker or author intends. So the very fact that the discourse says nothing about termination can be taken as a sign that the state is to be understood as persisting.

certainly true that the accommodation just described is one way of arriving at a coherent interpretation to the second sentence. But it is not the only one. The belief which (230) attributes to Bill on Sunday is that Mary is in Paris *on Sunday*. There are two ways in which this belief can persist as time goes on, either as the belief that Mary is in Paris in the sense of the “psychological present”, i.e. at the time at which the belief is entertained, or else as the belief that Mary was in Paris on Sunday. The accommodation mentioned above is to the effect that Bill’s belief persists as a belief “about the present”. For at the later time on Tuesday to which the accommodation extends the belief, the discourse referent *n* inside the characterisation of its content refers to this time on Tuesday, and not to the earlier time on Sunday, when Bill heard that Mary was in Paris. The more modest accommodation of the belief that Mary was in Paris on Sunday requires that the belief content now be represented in a different way, not as a “present tense” but as a “past tense belief”: the time of the state of Mary being in Paris must now be represented as one before (the embedded occurrence of) *n*, rather than simultaneous with *n*. This second accommodation leaves it open whether Bill believed on Tuesday that Mary was still in Paris then, whereas the first accommodation claims this. We will show both accommodations below. As we will see, they have slightly different consequences for the remaining aspects of the interpretation of the second sentence of (228).

A further observation concerns the use of the past perfect. It was observed in Section (3.5) that this tense is typically interpreted as involving a past Temporal Perspective Point, locating the described eventuality in the past of this TP-point. In the present case there are two possible choices for this TP-point, (i) the time of the event *e* introduced by *hear* in the first sentence and (ii) the event *e'* introduced by *learn* in the matrix clause of the second sentence. The first choice places the event of Mary’s leaving before Sunday. So, on this interpretation the information which Bill gets on Tuesday contradicts what he heard on Sunday. In view of the “corrective” character which (228) takes on with this interpretation, one would, if this had been the intended interpretation, have expected some kind of contrastive element, such as e.g. *but* as first word of the second sentence, to bear witness to the contrast between the claim made by the first sentence and that made by the second. So, without dwelling further on the general principle at work here, we take the absence of such a particle as a justification for choosing the second option, according to which the event of Mary’s leaving Paris occurred before Tuesday.

A similar ambiguity arises also in connection with the interpretation of the temporal adverbial *the day before*. This adverbial has the form of a definite description, and its referent has to be determined accordingly. The descriptive content of this description is the relational expression *day before*. Like the verb *leave*, this phrase can occur either with an explicit second argument, as in *day before Sunday*, say, or without any phrase designating this argument. The latter possibility is the one we find realised in (228). And like with the verb *leave* there is in such cases an implication to the effect that the missing argument should be recoverable from the context. Moreover, when the phrase *the day before* occurs as adjunct to a finite

VP, it is subject to a default recovery principle according to which the missing argument is the TP-point that is also needed to interpret the tense of the clause. This means that if we take the time of the event e as TP-point, then the *the day before* gets an interpretation on which it denotes the Saturday before the mentioned Sunday; and when the time of e' is taken as TP-point, then the phrase is understood as denoting the following Monday. Since we have already decided to identify the TP-point with e' , we are led to interpret the description as denoting the Monday.

(231) gives the preliminary representation for the second sentence of (228), and (232) and (233) the updates of the context DRS (230) with the two mentioned accommodations. After these diagrams we will first have to say a few more things about presupposition justification of (231) on the basis of, respectively, (232) and (233). Only after that we will give, in (234) and (235) the representations of (228) which result when all presuppositions have been resolved and the representation of the new sentence has been merged with the context representation.

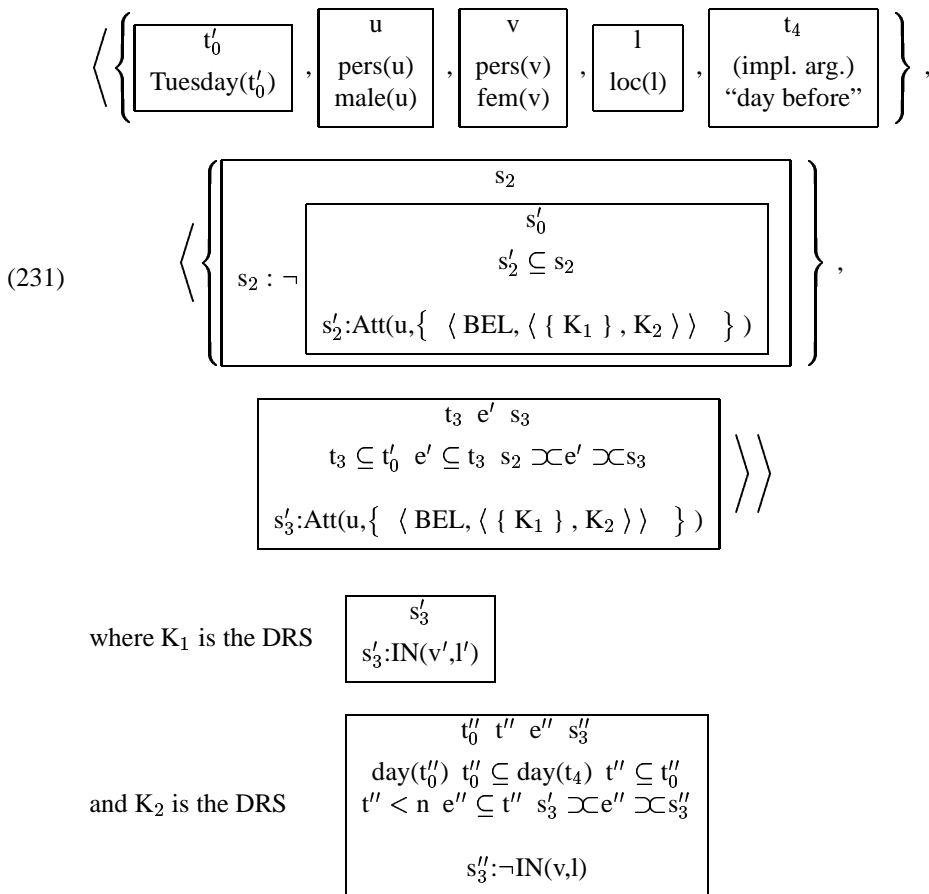

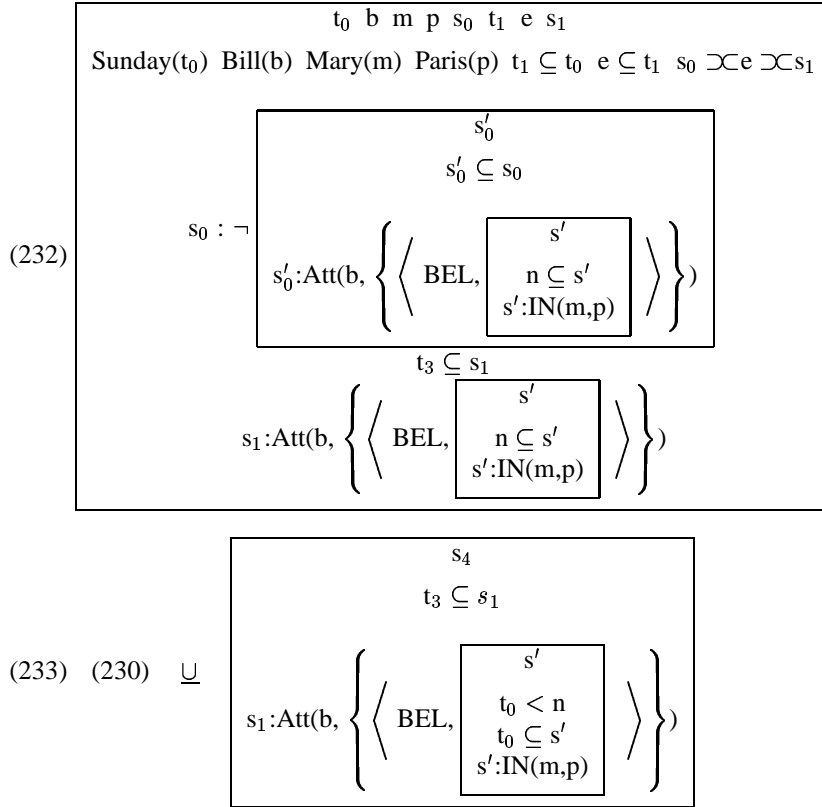

N.B. In both (232) and (233) the accommodation involves adding a condition which guarantees that the belief about Mary being in Paris lasts up to the time t_3 of the event e' of 231. In the case of (232) this can be represented simply by insisting that the very belief state s_1 of (230) overlaps with t_3 . The case of (233) is somewhat more involved since here the representation of the content of the belief has to be modified so that it suits the new, later belief time t_3 .

Presupposition Resolution for the Preliminary Representation of the Second Sentence of (228)

As stated above, each of the updated contexts (232) and (233) makes it possible to justify the pre-state presupposition of *leave* in (231). (This requires that u be resolved to b , v to m , l to p and t_4 to t_1 .) But there is an obvious difference between the two cases: the belief attributed to Bill in (233) is compatible with the belief that is attributed to him in (231), but the belief attribution of (232) is not. This means that the two interpretations corresponding to (232) and (233), while both possible, are conceptually quite different. If Bill was, at the time on Tuesday when he learned about Mary's departure, in the doxastic state indicated in (233), then it is reasonable to assume that his new doxastic state results from the immediately preceding one through simple addition of the new belief that

Mary left Paris on Monday. If Bill's immediately preceding doxastic state is as described in (232), then addition to it of the new belief represented in (231) leads to a contradiction so obvious that it is hardly credible that Bill should have acquiesced in it. Almost certainly he will have revised his former beliefs in the light of what has just become known to him. The intuitively most likely revision would be that Mary didn't remain in Paris until Tuesday – in other words, that the state of her being in Paris did not persist as far into the future as Bill had erroneously supposed up to that point. This leads us back to (233), the result of the weaker accommodation of (230). After merging with the non-presuppositional part of (231), we get the representation given in (234).

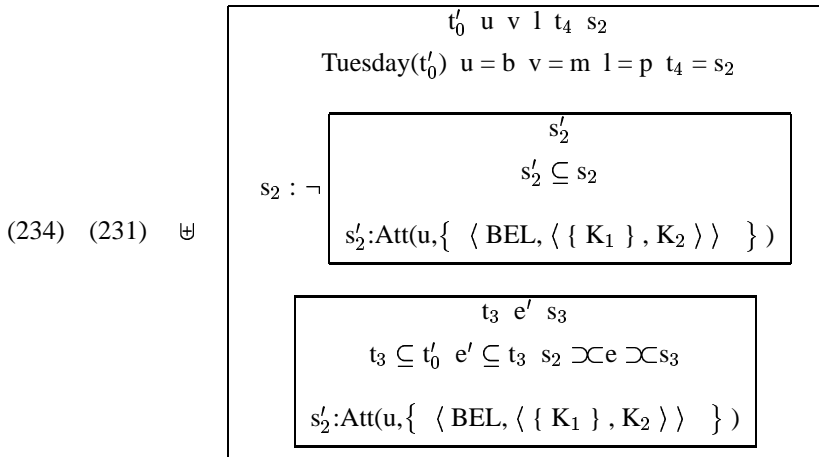

where again K_1 and K_2 are as under (231).

The representation in (234) seems very similar to that in (233). For one thing the two represent the same truth conditions. It should be stressed, however, that as *interpretations* of (228) they are clearly distinct. The stories that (232) and (233) tell about Bill up to the time when he learned that Mary left on the previous day differ in important details. That the representation in (234), which is based on the accommodation shown in (232), converges in the end with the one that is based on (227), depends crucially on the likely assumption that in the case of (232) Bill will have revised his earlier belief in the light of his new information. Belief revision, however, is something very different from what goes on when we arrive, by merely following the linguistic rules of interpretation, at a semantic representation that is inconsistent right away.

The discussion of this last section has demonstrated the same problems of exposition that became evident already in connection with the last one: A large number of seemingly unrelated details, many of which also had no direct bearing on the issues which the example was meant to illustrate. We already drew attention to this at the outset of the last section; if we return to the observation once more here, it is in the hope that the reader is in a better position now to appreciate the

quandary: Any example which illustrates the points on which the last two subsections were trained, will present a comparable range of issues, some closely related to the central issues and others hardly or not at all. But even those which are not or only distantly related require some attention if the representations proposed are to come across as well-motivated. Our discussions of the two examples of these last subsections would have made a much less haphazard impression, if it had been possible to rely on antecedently given solutions of all those problems which we encountered and which are irrelevant or ancillary to our principal concerns. But this would have required a very different set-up of the present chapter, which in our own view would have made it quite unsuitable as a chapter for a Handbook. In the light of these considerations dealing with marginally relevant issues as they are tossed up by the examples chosen seemed to us the lesser of two evils.

Whether or not the mode in which we have proceeded in these sections is seen as satisfactory, there is an obvious moral that can be drawn: In order to provide a realistic account of the semantic representation of all but the simplest sentences and discourses one needs to appeal to a highly complex system of interacting interpretation rules.

For a good number of the issues which we were forced to treat on the fly in dealing with our examples more systematic treatments can be found in the DRT literature than they could be given here. But this isn't the case for all of them. DRT may compare quite favourably with other frameworks for natural language semantics when it comes to coverage, but its coverage is still quite limited nonetheless. This means in particular that building a DRT-based semantics for a fragment of a natural language such as English which is large enough to permit relatively unimpeded use in all but the most special contexts remains a big challenge.

As regards the issues which have been our central concern in these last two subsections – viz. the ways in which successive attitude attributions can be semantically connected – there is a special reason why it is hard to come up with examples that illustrate the point without getting involved in additional problems. This is because so many natural examples which illustrate this kind of connectedness establish the connection by means of an anaphoric expression in the second attribution, which picks up the propositional content attributed by the first one. Some examples are given in 235.

- (235) a. Bill thought that Mary was in Paris. But then he discovered that this wasn't so.
- b. Bill thought that Mary was in Paris. But then he discovered that he was wrong.
- c. For many years Bill wanted to make a trip to Egypt, but he doesn't want to any more now.
- d. Bill very much wanted to prove that theorem and he was terribly pleased that he had when at last he had succeeded.

- e. Bill had wanted to be a politician, but when he understood why he wanted this, his desire disappeared.

Pronominal and demonstrative reference to propositional attitudes and their contents is a subject in its own right, which goes well beyond what we have touched upon here. It is a topic that has received a considerable amount of attention in the DRT-related literature, cf. [Asher1993]. The same is true of ellipsis. Here too there is a growing literature (See **Hardt (??)**, **Asher & Hardt (????)**, [Schiehlen1999]. (235.e), moreover, points up a problem of a different sort. Many of our attitudes are “second order” in that they are about some of our own attitudes. (A belief which you entertain about the origin of one of your desires is only one of a wide variety of different types of such second order attitudes.) It might be thought that such attitudes can be represented in much the same way in which the present formalism represents attitude attributions that one person makes to another (and about which we will have more to say in the next subsection). However, representing self-reflection in this way fails to capture one special feature of attributing properties to one’s own thoughts. Such attributions have a kind of transparency that isn’t there when we attribute thoughts to others. Whenever we attribute a thought to someone else, we must rely on hypotheses about what thoughts this person has. These hypotheses involve representations we form of the other’s thoughts and to the question whether or how closely they capture the thoughts which we attribute to the other correctly there is rarely if ever a conclusive answer. But when we think about our own thoughts, then the subjects of our reflections are immediately accessible to us, with an immediacy that is reminiscent of how the direct access we have to our own selves. The thoughts that are formed in self-reflection are thus thoughts which are directly about the first order thoughts on which they are targeted; their contents are singular propositions whose subjects are other thoughts. But they are singular propositions of a special kind, similar to the singular proposition about my own self that is the content of the thought I have when thinking, say, “I want to go home”.

Self-reflection is an important topic within the general theory of propositional attitudes and attitude attributions, but it is one we will not pursue here. A proposal for the representation of self-reflective thoughts within the present framework can be found in (**Kamp, forthc.**) [**English paper on propositional attitudes and their representations.**].

Shared Attitudes between Different Agents

Our last example concerns the possibility of referentially connected attributions to different agents. Consider:

- (236) Phoebe believes that a man broke into her garden and that he stole her prize zucchini. Ella thinks he didn’t take anything.

The first sentence leads to the same representation as the two sentences of (220). One of these representations was given in (224) and we will assume that it is this

attitude ! shared

representation which the interpreter of (236) assigns to its first sentence. (224) is repeated here as (237), in the abridged notation in which internal and external anchors are not explicitly mentioned and after merging of the representations of the two conjuncts of the first sentence into a single DRS.:

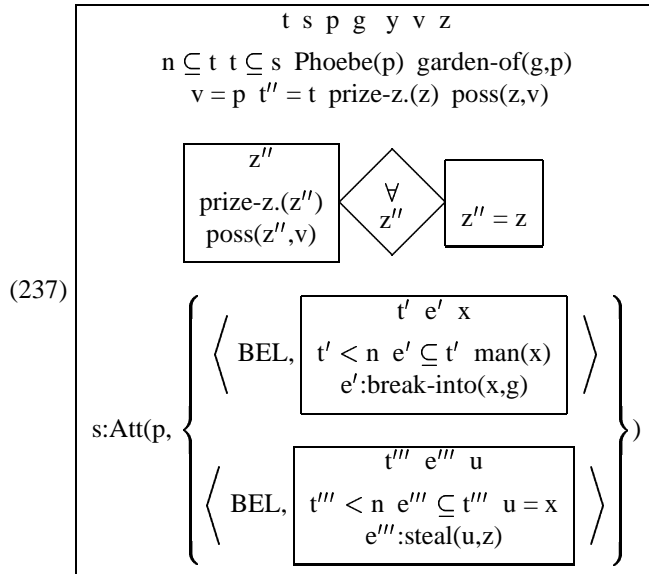

(237) is the context of interpretation for the second sentence of (236). One of the questions which arise in connection with the interpretation of this sentence is on the face of it quite similar to a problem we encountered when discussing the second sentence of (228). There a persistence accommodation was necessary to extend the belief that the first sentence attributes to Bill at t_1 to the later time t_2 , so that it could serve as context of interpretation for the belief attribution made by the second sentence. In (236) a similar problem arises in connection with the pronoun *he* in the second sentence. What does this pronoun refer to? “Well”, one might be inclined to reply, “to the man of whom Phoebe believes that he broke into her garden and stole her prize zucchini.” But how and in what sense can Ella’s thought be about this man, if, as we assumed in our discussion of (220), there is for all we know no such man in reality, and if what is said in the first sentence is a figment of Phoebe’s imagination? Clearly, the anaphoric relation between *a man* in the first and *he* in the second sentence of (236) makes no sense unless there is some mental content which Ella shares with Phoebe. What is needed, therefore, is an accommodation according to which some of what the first sentence attributes to Phoebe is also part of the beliefs of Ella.

But what exactly should be accommodated in this case? That is not so easy to say. On the one hand, as much should be accommodated as is necessary for a meaningful interpretation of *he*. On the other, the accommodation should be modest enough to avoid attributing to Ella beliefs that are so plainly contradictory

that they could only be seen as incoherent. One possibility which meets these two conditions – but it is only one among several – is to accommodate the belief attributed to Phoebe by the first conjunct of the first sentence of (236) as a belief of Ella's, but not the one attributed by the second. (239) below shows the effect of this accommodation on (237). First, however, we need the preliminary representation for the second sentence of (236). This representation is given in (238)

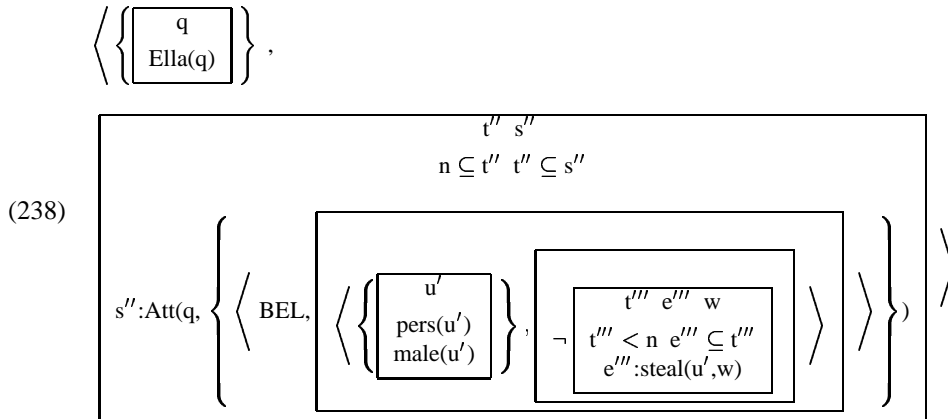

Justification of (238) in the context of (237) includes, first, the justification of the presupposition introduced by the proper name *Ella*. Here we proceed as we did in the last example: assuming that the context in which this presupposition must be justified contains no more information than what is given in (237), accommodation is the only way, and it is what recipients normally do when they are confronted with a name whose referent they cannot identify by independent means.

We will assume, then, that this presupposition is accommodated and that the accommodation has yielded a discourse referent *q* in the main universe, which represents the referent of the name.

It is now possible to accommodate the first of the two beliefs in (237) as a belief of Ella's. The two accommodations together yield (239)

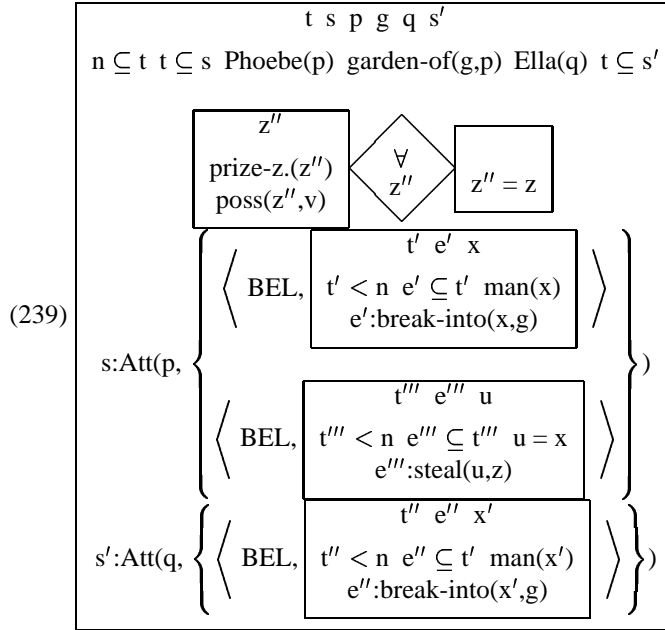

(239) can only be regarded as an intermediate accommodation result, for we still have to deal with the presupposition generated by *he* in the last sentence of (236). This presupposition can be resolved in the secondary context given by the accommodated belief, applying the same resolution principle that we already made use of in our treatment of (220) and (228). The result of this last resolution (which takes the form of adding the discourse referent *u* to the universe of the DRS characterising the belief in (239) and adding “ $u = x'$ ” to its conditions), and the merge with (238) which follows it, is given in (240)

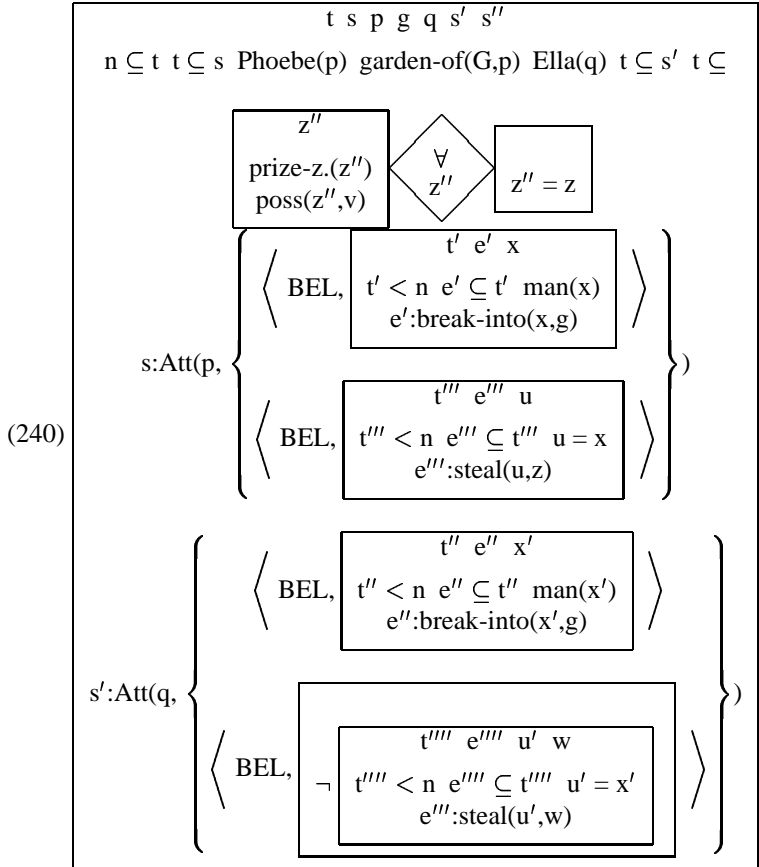

The interpretation problem on which we have focused in our discussion of (236) is closely related to one that has received a good deal of attention in the literature, especially from philosophers of language. This second problem is known as the ‘‘Hob-Nob problem’’, after the example sentence which was used by Geach to introduce the problem:

Hob-Nob problem

(241) Hob believes that a witch has killed Cob’s cow and Nob thinks that she has blighted Bob’s sow.

Geach pointed out that this sentence could be used truthfully in a report composed by a journalist describing the goings-on in some remote rural backwater, even if the journalist herself is persuaded that witches do not exist. This is a problem for the application of standard logical notation to the representation of truth-conditional content. For in order that the pronoun *she* in the belief attribution to Nob be bound by the ‘‘existential quantifier’’ *a witch* in the belief attribution to Hob, this quantifier would have to take scope over the two belief attributions. But this would, on the standard interpretation of quantification theory, imply that there are witches in the

world in which Hob, Nob and the journalist live. That is something to which the journalist would under no conditions want to commit herself. And it is something to which (241) does not commit her.

23 24 25 26

(21) Bill did see (in the mirror standing against the back wall) that his trousers were on fire. But unfortunately he didn't realise that it was him.

Part of the point of this example is that the effect of Bill's discovery that "it is me" is likely to be dramatic: The discovery may be expected to radically change the way in which he responds to the information which his belief represents to him. And this is so in spite of the fact that from a certain perspective on propositional content the discovery does not seem to produce a difference; both before and after the discovery the propositional content of the belief is a singular proposition which attributes to the person Bill the property of wearing burning trousers.

To our knowledge the first person who clearly saw the importance of the different interpretational strategies for pronouns occurring in the complements of attitudinal verbs was H.-N. Castañeda. In Castañeda's terminology pronoun occurrences that are given what we call the *de se* interpretation are called quasi-indicators.

In the context of (18) the *de se* interpretation of her seems intuitively much more plausible than the "merely *de re*" interpretation. And that seems to be true more generally: the *de re* interpretations of self-referring pronouns are highly marked, and will only occur to the interpreter when the context carries a strong inducement.

27 28 29

30 Note that there is no need to adapt our notions of PISBAS and ISBAS to the more comprehensive repertoire of DRs we are considering now, in which internal and external anchors have their place too. For the cases of singularity (of propositions and, by extension, of information states and CCPs to which anchoring gives rise are included in the original Def. 2. However, it is only at this point that the possibility of ISBASs containing singular information states, etc as constituents becomes essential. ADSs can now determine such singular semantic objects, and when they do, they will be subsumed by the relevant values of ASM only if those values have corresponding constituents which are singular as well. 31 Pronouns occurring in the complement of an attitude predicate or in the complement of a predicate *dicendi*, and which are given a *de se* interpretation are also sometimes called "quasi-indicators". The term was coined by Castaneda, who was the first to investigate the *de se* interpretation of third person pronouns closely) [ref.s]. 32 Think of Bill seeing no more than the lower part of himself, with the burning trousers, and that he thinks on the strength of what he sees: "Soon this guy's shirt will be on fire too." He hasn't seen the shirt the man is wearing but assumes, on the basis of general knowledge, that the man, if he wears the trousers he can see, will also be wearing a (unique) shirt. Here poor bill may be right that the person he is seeing does wear a shirt, and he may also be right in thinking that that shirt will be presently on fire, but the part of his attitudes that corresponds to his shirt does not have an anchored representation for the shirt, and a *de re* representation for

himself as the owner of the shirt.

6 LEXICON

to be written

7 UNDERSPECIFICATION

to be written

BIBLIOGRAPHY

- [Ahn and Kolb1990] Ahn, R. and Kolb, H.-P. 1990. Discourse representation meets constructive mathematics. In Kalman, L. and Polos, L., editors 1990, *Papers from the Second Symposium on Logic and Language*. Akademiai Kiadoo, Budapest. 105–124.
- [Asher and H.Kamp1989] Asher, N. and H.Kamp, 1989. Self-reference, attitudes and paradox. In Chierchia, Gennaro; Partee, Barbara; and Turner, Raymond, editors 1989, *Properties, Types and Meaning*, volume 1. Kluwer, Dordrecht.
- [Asher and Lascarides1998] Asher, N. and Lascarides, A. 1998. Bridging. *Journal of Semantics* 83–113.
- [Asher and Lascarides2003] Asher, Nicholas and Lascarides, Alex 2003. *Logics of Conversation*. Cambridge University Press.
- [Asher1986] Asher, N. 1986. Belief in discourse representation theory. *Journal of Philosophical Logic* 15:127–189.
- [Asher1993] Asher, N. 1993. *Reference to Abstract Objects in Discourse*. Kluwer, Dordrecht, Dordrecht.
- [Bach1981] Bach, E. 1981. On time, tense and aspect: An essay in english metaphysics. In Cole, P., editor 1981, *Radical Pragmatics*. Academic Press, New York, New York. 62–81.
- [Barwise and Cooper1993] Barwise, J. and Cooper, R. 1993. Extended Kamp notation. In Aczel, P.; Israel, D.; Katagiri, Y.; and Peters, S., editors 1993, *Situation Theory and its Applications, Volume III*. CSLI. chapter 2, 29–54.
- [Barwise et al.1991] Barwise, J.; Gawron, J. M.; Plotkin, G.; and Tutiya, S. 1991. *Situation Theory and its Applications, volume II*. CSLI and University of Chicago.
- [Benthem1983] Benthem, J.F.A.K. van 1983. *The Logic of Time*. Reidel, Dordrecht, Dordrecht.
- [Bos et al.1994] Bos, J.; Mastenbroek, E.; McGlashan, S.; Millies, S.; and Pinkal, M. 1994. A compositional DRS-based formalism for NLP-applications. In *International Workshop on Computational Semantics*, Tilburg.
- [Bos et al.1995] Bos, J.; Mineur, A.-M.; and Buitelaar, P. 1995. Bridging as coercive accommodation. In *CLNLP*, Edinburgh.
- [Briscoe et al.1993] Briscoe, E.; Paiva, V.de; and Copestake, A., editors 1993. *Inheritance, Defaults and the Lexicon*. Cambridge University Press.
- [Caenepeel1989] Caenepeel, Mimo 1989. *Aspect, Temporal Ordering and Perspective in Narrative Fiction*. Ph.D. Dissertation, University of Edinburgh.
- [Chierchia1991] Chierchia, G. 1991. Anaphora and dynamic binding. *Linguistics and Philosophy* 15(2):111–183.
- [Chierchia1993] Chierchia, G. 1993. Questions with quantifiers. *Natural Language Semantics* 1:181–234.
- [Chomsky1981] Chomsky, N. 1981. *Lectures on Government and Binding*. Foris, Dordrecht.
- [Clark1997] Clark, H. 1997. Bridging. In Johnson-Laird, P. N. and Wason, P. C., editors 1997, *Thinking: Readings in Cognitive Science*. Cambridge University Press. 411–420.
- [Cooper et al.1990] Cooper, R.; Mukai, K.; and Perry, J. 1990. *Situation Theory and its Applications, volume I*. CSLI and University of Chicago.
- [Dekker1993] Dekker, P. 1993. *Transsentential Meditations*. Ph.D. Dissertation, Department of Philosophy, University of Amsterdam.
- [Dov Gabbay and Finger2000] Dov Gabbay, Mark Reynolds and Finger, Marcelo 2000. *Temporal Logic*, volume Volume II. Oxford.
- [Dov Gabbay and Reynolds1994] Dov Gabbay, Ian Hodkinson and Reynolds, Mark 1994. *Temporal Logic*, volume Volume I. Oxford.
- [Dowty1979] Dowty, D.R 1979. *Word Meaning and Montague Grammar*. Reidel, Dordrecht, Dordrecht.
- [Eberle1997] Eberle, Kurt 1997. Flat underspecified representation and its meaning for a fragment of german. Technical report, Sonderforschungsbereich 340, Report.
- [Eijck and Kamp1997] Eijck, J. van and Kamp, H. 1997. Representing discourse in context. In Benthem, J. van and Meulen, A.ter, editors 1997, *Handbook of Logic an Language*. Elsevier, Amsterdam. 179–237.
- [Engdahl1980] Engdahl, E. 1980. *The Syntax and Semantics of Questions in Swedish*. Ph.D. Dissertation, University of Massachusetts at Amherst. Distributed by the GLSA, Department of Linguistics, University of Massachusetts at Amherst.

- [Fabricius-Hansen1980] Fabricius-Hansen, Catherine 1980. Lexikalische Dekomposition, Bedeutungspostulate und *w i e d e r*. Ein Beitrag zu einer Montague- Grammatik des Deutschen. In Katovsky, Dieter, editor 1980, *Perspektiven der lexikalischen Semantik*. Kohlhammer. 26 – 40.
- [Fabricius-Hansen1983] Fabricius-Hansen, Cathrine 1983. Wieder ein *w i e d e r*? Zur Semantik von *w i e d e r*. In Bäuerle, Rainer; Scharze, Christoph; and Stechow, Arnimvon, editors 1983, *Meaning, Use and Interpretation of Language*. Berlin, New York: de Gruyter. 97–120.
- [Fernando1992] Fernando, Tim 1992. Transition systems and dynamic semantics. In *Logics in AI, LNCS 633*. Springer-Berlin, Berlin.
- [Fernando1994] Fernando, Tim 1994. What is a drs? In *First International Workshop on Computational Semantics*, Tilburg, The Netherlands.
- [Fernando2001a] Fernando, Tim 2001a. Conservative generalized quantifiers and presupposition. In *Proceedings, Eleventh Semantic and Linguistic Theory conference (SALT XI)*, New York University. 172–191.
- [Fernando2001b] Fernando, Tim 2001b. A type reduction from proof-conditional to dynamic semantics. *Journal of Philosophical Logic* 30(2):121–153.
- [Fodor1975] Fodor, J. 1975. *The Language of Thought*. Harvard University Press.
- [Frank and Reyle1995] Frank, A. and Reyle, U. 1995. Principle based semantics for hpsg. In *Proceedings of the 7th Conference of the EACL, March 27-31, Dublin*. 9–16.
- [Gamut1991] Gamut, L.T.F. 1991. *Language, Logic and Meaning, Part 2*. Chicago University Press, Chicago.
- [Gärdenfors1988] Gärdenfors, P. 1988. *Knowledge in Flux: Modelling the Dynamics of Epistemic States*. MIT Press, Cambridge Mass.
- [Geach1962 Third revised edition 1980] Geach, P.T. 1980. *Reference and Generality : An Examination of Some Medieval and Modern Theories*. Cornell University Press, Ithaca.
- [Genabith and Crouch1999] Genabith, J. van and Crouch, R. 1999. Dynamic and underspecified semantics for lfg. In Dalrymple, Mary, editor 1999, *Semantics and Syntax in Lexical Functional Grammar: The Resource Logic Approach*. MIT Press, Cambridge, Massachusetts. 209–260.
- [Geurts and van der Sandt] Geurts, Bart and Sandt, Robvan der ndt. Presuppositions and backgrounds. In *Proceedings of the 11th Amsterdam Colloquium*. University of Amsterdam.
- [Geurts1997] Geurts, B. 1997. Good news about the description theory of names. *Journal of Semantics* 14:319–348.
- [Geurts1999] Geurts, Bart 1999. *Presuppositions and Pronouns*. Elsevier Science.
- [Goldblatt1992 first edition 1987] Goldblatt, R. 1987. *Logics of Time and Computation, Second Edition, Revised and Expanded*, volume 7 of *CSLI Lecture Notes*. CSLI, Stanford. Distributed by University of Chicago Press.
- [Groenendijk and Stokhof1990] Groenendijk, J. and Stokhof, M. 1990. Dynamic montague grammar. In Kalman, L. and Polos, L., editors 1990, *Papers from the Second Symposium on Logic and Language*. Akademiai Kiaduo, Budapest. 3–48.
- [Groenendijk and Stokhof1991] Groenendijk, J. and Stokhof, M. 1991. Dynamic predicate logic. *Linguistics and Philosophy* 14:39–100.
- [Hans and Reylems] Hans, Kamp and Reyle, Uwe ems. *From Discourse to Logic*, volume II.
- [Harel1984] Harel, D. 1984. Dynamic logic. In Gabbay, D. and Guentner, F., editors 1984, *Handbook of Philosophical Logic*. Reidel, Dordrecht. 497–604. Volume II.
- [Heim1982] Heim, I. 1982. *The Semantics of Definite and Indefinite Noun Phrases*. Ph.D. Dissertation, University of Massachusetts, Amherst.
- [Heim1983] Heim, I. 1983. On the projection problem for presuppositions. *Proceedings of the West Coast Conference on Formal Linguistics* 2:114–126.
- [Hinrichs1986] Hinrichs, E. 1986. Temporal anaphora in discourses of english. *Linguistics and Philosophy* 9(1):63–81.
- [Hobbs1990] Hobbs, Jerry R 1990. The coherence and structure of discourse. In *Literature and cognition*. CSLI. CSLI Lecture notes, 21.
- [Hodges2001] Hodges, Wilfrid 2001. Elementary predicate logic. In Gabbay, Dov, editor 2001, *Handbook of Philosophical Logic*, volume I. Reidel, second edition.
- [Kadmon1987] Kadmon, N. 1987. *On Unique and Non-Unique Reference and Asymmetric Quantification*. Ph.D. Dissertation, University of Massachusetts at Amherst.
- [Kamp and Reyle1991] Kamp, H. and Reyle, U. 1991. A calculus for first order discourse representation structures. Arbeitspapiere des Sonderforschungsbereichs 340 16, IMS Stuttgart, Germany.
- [Kamp and Reyle1993] Kamp, H. and Reyle, U. 1993. *From Discourse to Logic*. Kluwer, Dordrecht.

- [Kamp and Rohrer1983a] Kamp, H. and Rohrer, C. 1983a. Tense in texts. In Bäuerle, ; Schwarze, ; and Stechow, Von, editors 1983a, *Meaning, Use and Interpretation of Language*. De Gruyter, Berlin. 250–269.
- [Kamp and Rohrer1983b] Kamp, Hans and Rohrer, Christian 1983b. Temporal Reference in French. ms. Stuttgart.
- [Kamp and Schiehlen2002] Kamp, Hans and Schiehlen, Michael 2002. *How to say WHEN it happens*. Niemeyer. chapter Temporal Location in Natural Language.
- [Kamp1971] Kamp, Hans 1971. Formal properties of “NOW”. *Theoria* 37:227 – 273.
- [Kamp1979] Kamp, H. 1979. Events, instants and temporal reference. In Bäuerle, ; Egli, ; and Stechow, Von, editors 1979, *Semantics from Different Points of View*. Springer, Berlin.
- [Kamp1981a] Kamp, H. 1981a. A theory of truth and semantic representation. In Groenendijk, J. and others, , editors 1981a, *Formal Methods in the Study of Language*. Mathematisch Centrum, Amsterdam.
- [Kamp1981b] Kamp, Hans 1981b. Événements, representation discursive et reference temporelle. *Langages* 64:39–64.
- [Kamp1990] Kamp, H. 1990. Prolegomena to a structural account of belief and other attitudes. In Anderson, C. A. and Owens, J., editors 1990, *Propositional Attitudes—The Role of Content in Logic, Language, and Mind*. University of Chicago Press and CSLI, Stanford. chapter 2, 27–90.
- [Kamp2001a] Kamp, Hans 2001a. The importance of presupposition. In Rohrer, Christian; Ross-deutscher, Antje; and Kamp, Hans, editors 2001a, *Linguistic Form and its Computation*. CSLI-Publications, Standord.
- [Kamp2001b] Kamp, Hans 2001b. Presupposition computation and presupposition justification. In Bras, Myriam and Vie, Laure, editors 2001b, *Pragmatic and Semantic Issues in Discourse and Dialogue*. Elsevier.
- [Kaplan and Bresnan1982] Kaplan, R.M. and Bresnan, J. 1982. Lexical functional grammar. In Bresnan, J., editor 1982, *The mental representation of grammatical relations*. MIT Press, Cambridge Mass. 173–281.
- [Kaplan1969] Kaplan, D. 1969. Quantifying in. In Davidson, D. and Hintikka, J., editors 1969, *Words and Objections: Essays on the Work of W. V. Quine*. Dordrecht: Reidel.
- [Karttunen1976] Karttunen, L. 1976. Discourse referents. In McCawley, J., editor 1976, *Syntax and Semantics* 7. Academic Press. 363–385.
- [Keenan and Westerstahl1997] Keenan, E. and Westerstahl, D. 1997. Generalized quantifiers in linguistics and logic. In Benthem, J.van and Meulen, A.ter, editors 1997, *Handbook of Language and Logic*. Elsevier. 837–893.
- [Keenan1992] Keenan, E. 1992. Beyond the frege boundary. *Linguistics and Philosophy* 199–221.
- [Kohlhase et al.1996] Kohlhase, M.; Kuschert, S.; and Pinkal, M. 1996. A type-theoretic semantics for λ -drt. In Dekker, P. and Stokhof, M., editors 1996, *Proceedings of the Tenth Amsterdam Colloquium*. ILLC, University of Amsterdam.
- [Koons1988] Koons, 1988. Deduction system for drt. (ms.) Austin, Texas.
- [Krause2001] Krause, Peter 2001. *Topics in Presupposition Theory*. Ph.D. Dissertation, Universität Stuttgart.
- [Kripke1972] Kripke, S.A. 1972. Naming and necessity. In Davidson, D. and Harman, G., editors 1972, *Semantics of Natural Language*. Reidel, Dordrecht. 253–355.
- [Kripke1979] Kripke, S. 1979. A puzzle about belief. In Margalit, A., editor 1979, *Meaning and Use*. Reidel, Dordrecht.
- [Lascarides and Asher1993] Lascarides, Alex and Asher, Nicholas 1993. Temporal interpretation, discourse relations, and common sense entailment. *Linguistics and Philosophy* 16:437–49.
- [Lascarides and Copestake1999] Lascarides, Alex and Copestake, Ann 1999. Default representation in constraint-based frameworks. *Computational Linguistics*.
- [Lasersohn1995] Lasersohn, Peter 1995. *Plurality, Conjunction and Events*. Kluwer Academic Publishers.
- [Lewis1975] Lewis, D. K. 1975. Adverbs of quantification. In Keenan, E., editor 1975, *Formal Semantics of Natural Language*. Cambridge University Press, Cambridge.
- [Link1983] Link, G. 1983. The logical analysis of plurals and mass terms. In Bäuerle, R.; Schwarze, C.; and Stechow, A.von, editors 1983, *Meaning, Use and Interpretation of Language*. Walter de Gruyter, Berlin. 303–323.
- [Martin-Löf1984] Martin-Löf, P. 1984. *Intuitionistic Type Theory*. Bibliopolis.

- [Moens and Steedman1988] Moens, M. and Steedman, M. 1988. Temporal ontology and temporal reference. *Computational Linguistics* 14(2):15–28.
- [Montague1973] Montague, R. 1973. The proper treatment of quantification in ordinary english. In e.a., J. Hintikka, editor 1973, *Approaches to Natural Language*. Reidel. 221–242.
- [Muskens et al.1997] Muskens, R.; Benthem, J.van; and Visser, A. 1997. Dynamics. In Benthem, J. van and Meulen, A.ter, editors 1997, *Handbook of Logic an Language*. Elsevier, Amsterdam. 587–648.
- [Muskens1996] Muskens, R. 1996. Combining montague semantics and discourse representation. *Linguistics and Philosophy* 19:143–186.
- [Partee1984] Partee, B.H. 1984. Nominal and temporal anaphora. *Linguistics and Philosophy* 7.
- [Pollard and Sag1994] Pollard, C. and Sag, I. 1994. *Head-Driven Phrase Structure Grammar*. CSLI Lecture Notes. CSLI, Stanford. Distributed by University of Chicago Press.
- [Pratt1976] Pratt, V. 1976. Semantical considerations on Floyd–Hoare logic. *Proceedings 17th IEEE Symposium on Foundations of Computer Science* 109–121.
- [Quine1956] Quine, W.V.O 1956. Quantifiers and propositional attitudes. *Journal of Philosophy*.
- [Quine1961] Quine, W.V.O 1961. Reference and modality. In *From a Logical Point of View*. New York: Harper and Row. Reprinted in Linsky: Reference and Modality, London: Oxford University Press, 1971.
- [Ranta1995] Ranta, Aarne 1995. *Type-theoretical Grammar*. Oxford University Press.
- [Reichenbach1947] Reichenbach, H. 1947. *Elements of Symbolic Logic*. Macmillan, London.
- [Reinhard1989] Reinhard, 1989. Deduktionen auf diskursrepräsentationsstrukturen. Studienarbeit, IMS Stuttgart, Germany.
- [Reyle and Frey1983] Reyle, U. and Frey, W. 1983. A prolog implementation of lexical functional grammar. In *IJCAI 83, Karlsruhe, Germany*. 693–695.
- [Reyle and Gabbay1994] Reyle, U. and Gabbay, D. 1994. Direct deductive computation on discourse representation structures. *Linguistics and Philosophy* 17:343–390.
- [Reyle et al.2000] Reyle, Uwe; Rossdeutscher, Antje; and Kamp, Hans 2000. Ups and downs in the theory of temporal reference. In Reyle, Uwe, editor 2000, *Presuppositions and Underspecification in the Computation of Temporal and other Relations in Discourse*. Arbeitsberichte des Sonderforschungsbereichs 340, Stuttgart/Tübingen, Nr.164.
- [Reyle et al.2003] Reyle, Uwe; Rossdeutscher, Antje; and Kamp, Hans 2003. Ups and downs in the theory of temporal reference. ms. University of Stuttgart.
- [Rooth1992] Rooth, Mats 1992. A theory of focus interpretation. *Natural Language Semantics* 1:75–116.
- [Rossdeutscher and Reyle2000] Rossdeutscher, Antje and Reyle, Uwe 2000. Constraint-based bottom up discourse interpretation. In Reyle, Uwe, editor 2000, *Presuppositions and Underspecification in the Computation of Temporal and other Relations in Discourse*. Arbeitsberichte des Sonderforschungsbereichs 340, Stuttgart/Tübingen, Nr.164.
- [Roßdeutscher2000] Roßdeutscher, Antje 2000. *Lexikalisch gestützte formale Textinterpretation*. Arbeitsberichte des Sonderforschungsbereichs 340, Stuttgart/Tübingen, Nr.157.
- [Russell1905] Russell, B. 1905. On denoting. *Mind* 14:479–493.
- [Sandström1993] Sandström, Gørel 1993. *When-Clauses and the Temporal Interpretation of Narrative Discourse*. Ph.D. Dissertation, University of Umea.
- [Saurer1993] Saurer, W. 1993. A natural deduction system of discourse representation theory. *Journal of Philosophical Logic* 22(3):249–302.
- [Schiehlen1999] Schiehlen, Michael 1999. *Semantikonstruktion*. Ph.D. Dissertation, Universität Stuttgart.
- [SchiehlenJuly 2002] Schiehlen, Michael 2002. Ellipsis resolution with scope underspecification. In *Proceedings of the 40th Annual Meeting of the Association for Computational Linguistics*, Philadelphia PA.
- [Sedogbo1988] Sedogbo, C. 1988. Sylog: A drt system in prolog. In Dahl, V. and Saint-Dizier, P., editors 1988, *Natural Language Understanding and Logical Programming II*. Elsevier Science Publishers. 185–201.
- [Seizmair1996] Seizmair, Michael 1996. Nicht-fregeische quantifikation und dynamik. Diplomarbeit, University of Stuttgart.
- [Seuren1986] Seuren, P. 1986. *Discourse Semantics*. Blackwell, Oxford.
- [Soames1984] Soames, S. 1984. Presupposition. In Gabbay, D. and Guentner, F., editors 1984, *Handbook of Philosophical Logic*. Reidel. 553–616. Volume IV.

- [Stechow1996] Stechow, Arnim von 1996. The different readings of “wieder” (again): A structural account. *Journal of Semantics*.
- [Steedman2001] Steedman, M. 2001. *The Syntactic Process*. Bradford Books, MIT Press.
- [Stone1998] Stone, Matthiew 1998. *Modality in Dialogue: Planning, Pragmatics and Computation*. Ph.D. Dissertation, University of Pennsylvania.
- [Strawson1950] Strawson, P.F. 1950. On referring. *Mind* 59:320–344.
- [Strawson1964] Strawson, 1964. Intention and convention in speech acts. *Philosophical Review*.
- [Sundholm1986] Sundholm, G. 1986. Proof theory and meaning. In Gabbay, D. and Guentner, F., editors 1986, *Handbook of Philosophical Logic III*. Kluwer, Dordrecht. 471–506.
- [Sundholm2001] Sundholm, G. 2001. Systems of deduction. In Gabbay, D., editor 2001, *Handbook of Philosophical Logic II. Second Edition*. Kluwer, Dordrecht.
- [Thomason2002] Thomason, R. 2002. Combinations of tense and modality. In Gabbay, D., editor 2002, *Handbook of Philosophical Logic VII*. Kluwer, Dordrecht.
- [Turner1988] Turner, R. 1988. A theory of properties. *The Journal of Symbolic Logic* 54.
- [van der Does and van Eijck (eds.)1991] Does, J. van der and Eijck (eds.), J. van 1991. *Generalized Quantifier Theory and Applications*. Dutch Network for Language, Logic and Information.
- [van der Sandt1992] Sandt, R.A. van der 1992. Presupposition projection as anaphora resolution. *Journal of Semantics* 9:333–377. Special Issue: Presupposition, Part 2.
- [Vermeulen1995] Vermeulen, C.F.M. 1995. Merging without mystery, or: Variables in dynamic semantics. *Journal of Philosophical Logic* 35:405–450.
- [von Fintel1994] Fintel, Kai von 1994. *Restrictions on Quantifier Domains*. Ph.D. Dissertation, GLSA, UMass Amherst.
- [Webber1988] Webber, B.L. 1988. Tense as discourse anaphor. *Computational Linguistics* 14(2):61–73.
- [Westersthl1989] Westersthl, D. 1989. Topics in generalized quantifiers. In Gabbay, D. and Guentner, F., editors 1989, *Handbook of Philosophical Logic, Volume IV*. Reidel. 1–131.
- [Westerstahl1989] Westerstahl, D. 1989. Quantifiers in formal and natural languages. In Gabbay, D. and Guentner, F., editors 1989, *Handbook of Philosophical Logic, volume IV*. Reidel. 1–131.
- [Winter2002] Winter, Yoad 2002. *Flexibility Principles in Boolean Semantics. The Interpretation of Coordination, Plurality, and Scope in Natural Language*. The MIT Press.
- [Zeevat et al.1987] Zeevat, H.; Klein, E.; and Calder, J. 1987. Unification categorial grammar. In Haddock, N.; Klein, E.; and Morrill, G., editors 1987, *Categorial Grammar, Unification Grammar and Parsing*. Centre for Cognitive Science, University of Edinburgh. 195–222.
- [Zeevat1989] Zeevat, H. 1989. A compositional approach to discourse representation theory. *Linguistics and Philosophy* 12:95–131.
- [Zeevat1992] Zeevat, H. 1992. Presupposition and accommodation in update semantics. *Journal of Semantics* 9(4):379–412. Special Issue: Presupposition, Part 2.